

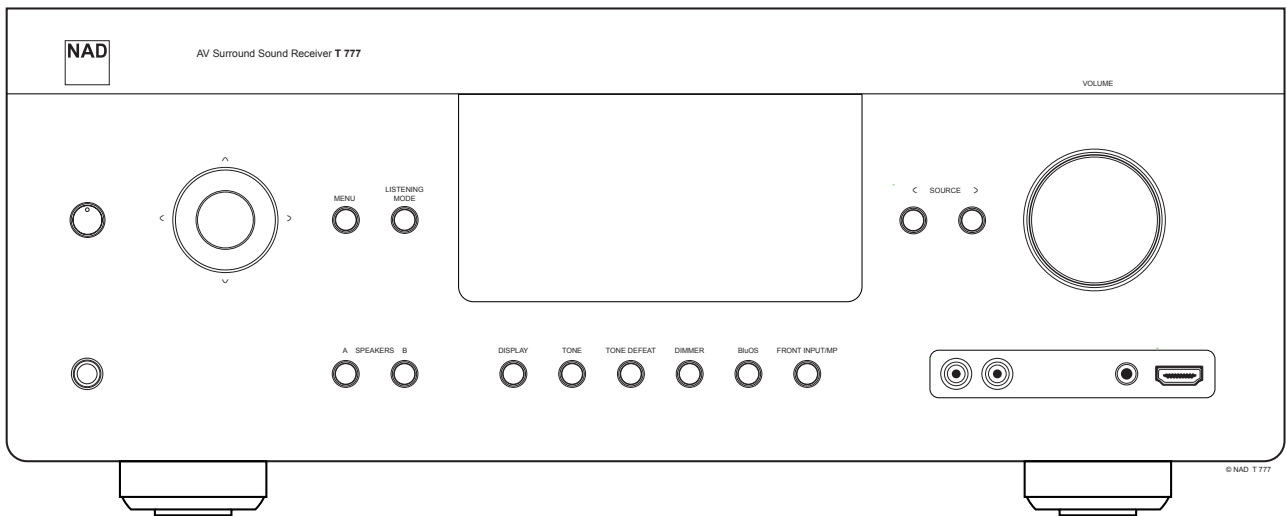

T 777

AV Surround Sound Receiver



Owner's Manual

IMPORTANT SAFETY INSTRUCTIONS

- 1. Read instructions** - All the safety and operating instructions should be read before the product is operated.
- 2. Retain instructions** - The safety and operating instructions should be retained for future reference.
- 3. Heed Warnings** - All warnings on the product and in the operating instructions should be adhered to.
- 4. Follow Instructions** - All operating and use instructions should be followed.
- 5. Cleaning** - Unplug this product from the wall outlet before cleaning. Do not use liquid cleaners or aerosol cleaners. Use a damp cloth for cleaning.
- 6. Attachments** - Do not use attachments not recommended by the product manufacturer as they may cause hazards.
- 7. Water and Moisture** - Do not use this product near water-for example, near a bath tub, wash bowl, kitchen sink, or laundry tub; in a wet basement; or near a swimming pool; and the like.
- 8. Accessories** - Do not place this product on an unstable cart, stand, tripod, bracket, or table. The product may fall, causing serious injury to a child or adult and serious damage to the product. Use only with a cart, stand, tripod, bracket, or table recommended by the manufacturer, or sold with the product. Any mounting of the product should follow the manufacturer's instructions, and should use a mounting accessory recommended by the manufacturer.
- 9.  Cart** - A product and cart combination should be moved with care. Quick stops, excessive force, and uneven surfaces may cause the product and cart combination to overturn.
- 10. Ventilation** - Slots and openings in the cabinet are provided for ventilation to ensure reliable operation of the product and to protect it from overheating. These openings must not be blocked or covered. The openings should never be blocked by placing the product on a bed, sofa, rug, or other similar surface. This product should not be placed in a built-in installation such as a bookcase or rack unless proper ventilation is provided or the manufacturer's instructions have been adhered to.
- 11. Power Sources** - This product should be operated only from the type of power source indicated on the marking label and connected to a MAINS socket outlet with a protective earthing connection. If you are not sure of the type of power supply to your home, consult your product dealer or local power company.
- 12. Power-Cord Protection** - Power-supply cords should be routed so that they are not likely to be walked on or pinched by items placed upon or against them, paying particular attention to cords at plugs, convenience receptacles, and the point where they exit from the product.
- 13. Mains Plug** - Where the mains plug or an appliance coupler is used as the disconnect device, the disconnect device shall remain readily operable.
- 14. Outdoor Antenna Grounding** - If an outside antenna or cable system is connected to the product, be sure the antenna or cable system is grounded so as to provide some protection against voltage surges and built-up static charges. Article 810 of the National Electrical Code, ANSI/NFPA 70, provides information with regard to proper grounding of the mast and supporting structure, grounding of the lead-in wire to an antenna discharge unit, size of grounding conductors, location of antenna discharge unit, connection to grounding electrodes, and requirements for the grounding electrode.

NOTE TO CATV SYSTEM INSTALLER

This reminder is provided to call the CATV system installer's attention to Section 820-40 of the NEC which provides guidelines for proper grounding and, in particular, specifies that the cable ground shall be connected to the grounding system of the building, as close to the point of cable entry as practical.

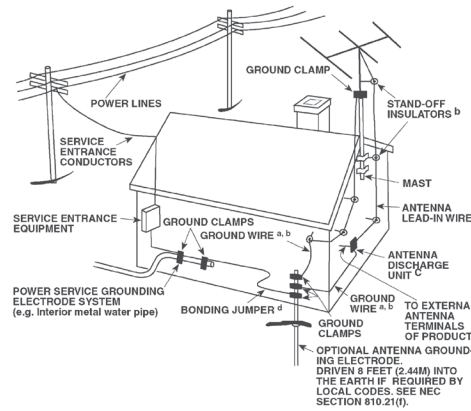

- 15. Lightning** - For added protection for this product during a lightning storm, or when it is left unattended and unused for long periods of time, unplug it from the wall outlet and disconnect the antenna or cable system. This will prevent damage to the product due to lightning and power-line surges.
- 16. Power Lines** - An outside antenna system should not be located in the vicinity of overhead power lines or other electric light or power circuits, or where it can fall into such power lines or circuits. When installing an outside antenna system, extreme care should be taken to keep from touching such power lines or circuits as contact with them might be fatal.
- 17. Overloading** - Do not overload wall outlets, extension cords, or integral convenience receptacles as this can result in a risk of fire or electric shock.
- 18. Flame Sources** - No naked flame sources, such as lighted candles, should be placed on the product.
- 19. Object and Liquid Entry** - Never push objects of any kind into this product through openings as they may touch dangerous voltage points or short-out parts that could result in a fire or electric shock. Never spill liquid of any kind on the product.
- 20. Headphones** - Excessive sound pressure from earphones and headphones can cause hearing loss.
- 21. Damage Requiring Service** - Unplug this product from the wall outlet and refer servicing to qualified service personnel under the following conditions:
 - When the power-supply cord or plug is damaged.
 - If liquid has been spilled, or objects have fallen into the product.
 - If the product has been exposed to rain or water.
 - If the product does not operate normally by following the operating instructions. Adjust only those controls that are covered by the operating instructions as an improper adjustment of other controls may result in damage and will often require extensive work by a qualified technician to restore the product to its normal operation.
 - If the product has been dropped or damaged in any way.
 - When the product exhibits a distinct change in performance-this indicates a need for service.
- 22. Replacement Parts** - When replacement parts are required, be sure the service technician has used replacement parts specified by the manufacturer or have the same characteristics as the original part. Unauthorized substitutions may result in fire, electric shock, or other hazards.

23. Battery Disposal - When disposing of used batteries, please comply with governmental regulations or environmental public instruction's rules that apply in your country or area.

24. Safety Check - Upon completion of any service or repairs to this product, ask the service technician to perform safety checks to determine that the product is in proper operating condition.

WARNING



The lightning flash with arrowhead symbol, within an equilateral triangle, is intended to alert the user to the presence of uninsulated "dangerous voltage" within the product's enclosure that may be of sufficient magnitude to constitute a risk of electric shock to persons



The exclamation point within an equilateral triangle is intended to alert the user to the presence of important operating and maintenance (servicing) instructions in the literature accompanying the appliance.



THE EQUIPMENT MUST BE CONNECTED TO AN EARTHED MAINS SOCKET-OUTLET.

CAUTION REGARDING PLACEMENT

To maintain proper ventilation, be sure to leave a space around the unit (from the largest outer dimensions including projections) than is equal to, or greater than shown below.

- Left and Right Panels: 10 cm
- Rear Panel: 10 cm
- Top Panel: 10 cm

FCC STATEMENT

This equipment has been tested and found to comply with the limits for Class B digital device, pursuant to Part 15 of the FCC Rules. These limits are designed to provide reasonable protection against harmful interference in a residential installation. This equipment generates, uses, and can radiate radio frequency energy and, if not installed and used in accordance with the instructions, may cause harmful interference to radio communications. However, there is no guarantee that interference will not occur in a particular installation. If this equipment does cause harmful interference to radio or television reception, which can be determined by turning the equipment off and on, the user is encouraged to try to correct the interference by one or more of the following measures:

- Reorient or relocate the receiving antenna.
- Increase the separation between the equipment and receiver.
- Connect the equipment into an outlet on a circuit different from that to which the receiver is connected.
- Consult the dealer or an experienced radio TV technician for help.

CAUTION

- Changes or modifications to this equipment not expressly approved by NAD Electronics for compliance could void the user's authority to operate this equipment.
- To prevent electric shock, match wide blade of plug to wide slot, fully insert.
- Danger of explosion if battery is incorrectly replaced. Replace only with the same or equivalent type.
- An appliance with a protective earth terminal should be connected to a mains outlet with a protective earth connection.

WARNING

- To reduce the risk of fire or electric shock, do not expose this apparatus to rain or moisture.
- The apparatus shall not be exposed to dripping or splashing and that no objects filled with liquids, such as vases, shall be placed on apparatus.
- Mains plug is used as disconnect device and it should remain readily operable during intended use. In order to disconnect the apparatus from the mains completely, the mains plug should be disconnected from the mains socket outlet completely.
- Battery shall not be exposed to excessive heat such as sunshine, fire or the like.

IF IN DOUBT CONSULT A COMPETENT ELECTRICIAN.



This product is manufactured to comply with the radio interference requirements of EEC DIRECTIVE 2004/108/EC.

NOTES ON ENVIRONMENTAL PROTECTION



At the end of its useful life, this product must not be disposed of with regular household waste but must be returned to a collection point for the recycling of electrical and electronic equipment. The symbol on the product, user's manual and packaging point this out.

The materials can be reused in accordance with their markings. Through re-use, recycling of raw materials, or other forms of recycling of old products, you are making an important contribution to the protection of our environment.

Your local administrative office can advise you of the responsible waste disposal point.

RECORD YOUR MODEL NUMBER (NOW, WHILE YOU CAN SEE IT)

The model and serial number of your new T 777 are located on the back of the cabinet. For your future convenience, we suggest that you record these numbers here:

Model number :
 Serial number :

INTRODUCTION

TABLE OF CONTENTS

IMPORTANT SAFETY INSTRUCTIONS2

INTRODUCTION

GETTING STARTED	5
WHAT'S IN THE BOX	5
CHOOSING A LOCATION	5
DEFAULT SOURCE SETTINGS	5

IDENTIFICATION OF CONTROLS

FRONT PANEL	6
REAR PANEL	8

OPERATION

USING THE T 777 – MAIN MENU	11
ABOUT THE ON-SCREEN DISPLAY (OSD)	11
MAIN MENU	11
DSP OPTIONS	11
TONE CONTROLS	12
ZONE CONTROLS	12
SYSTEM INFO	13
SETUP MENU	13
USING THE T 777 – SETUP MENU	14
CONTROL SETUP	14
SOURCE SETUP	15
SPEAKER SETUP	16
SPEAKER CONFIGURATION	16
SPEAKER LEVELS	17
SPEAKER DISTANCE	18
DIRAC LIVE	18
ADJUSTING THE VOLUME	18
ADJUSTING CHANNEL LEVELS 'ON THE FLY'	19
ZONE SETUP	19
AMPLIFIER SETUP	20
TRIGGER SETUP	20

LISTENING MODE SETUP	20
LISTENING MODES	21
DOLBY SETUP	22
DTS SETUP	22
ENHANCED STEREO	23
FRONT PANEL DISPLAY SETUP	23
A/V PRESETS	24
BluOS SETUP	27
SELECT LANGUAGE	27
MASTER QUALITY AUTHENTICATED	27

USING THE HTR 8 REMOTE CONTROL28

OVERVIEW OF THE HTR 8	28
GETTING FAMILIAR WITH THE HTR 8	28
LEARNING CODES FROM OTHER REMOTES	28
PUNCH THROUGH	29
COPY A COMMAND FROM ANOTHER KEY	29
MACRO COMMANDS	29
KEY ILLUMINATION TIMEOUT	30
CONFIGURING KEY ILLUMINATION	30
FACTORY RESET	30
DELETE MODE	30
LOADING CODE-LIBRARIES	31
SEARCH MODE	31
CHECKING CODE-LIBRARY NUMBER	31
SUMMARY OF THE HTR 8 MODES	31
USB INTERFACE	32
USING THE ZR 7 REMOTE CONTROL	32

USING IR CHANNEL33

IR CHANNEL ASSIGNMENT	33
-----------------------------	----

REFERENCE

TROUBLESHOOTING	34
SPECIFICATIONS	35

WHAT'S IN THE BOX

Packed with your T 777 you will find

- Quick Setup Guide
- BluOS Kit containing USB Hub, Wi-Fi Dongle, Bluetooth USB Micro Adapter and USB to USB Cable Extender
- HTR 8 remote control with 4 AA batteries
- BluOS-Ready Flyer/Bluesound player
- ZR 7 zone remote control with 3V CR2025 battery
- Measurement microphone with USB Mic adapter and phone jack adapter
- Detachable mains power cord

SAVE THE PACKAGING

Please save the box and all of the packaging in which your T 777 arrived. Should you move or otherwise need to transport your T 777, this is by far the safest container in which to do so. We've seen too many otherwise perfect components damaged in transit for lack of a proper shipping carton, so please: Save that box!

CHOOSING A LOCATION

Choose a location that is well ventilated (with at least several inches to both sides and behind), and that will provide a clear line of sight, within 25 feet/8 meters, between the T 777's front panel and your primary listening/viewing position—this will ensure reliable infrared remote control communications. The T 777 generates a modest amount of heat, but nothing that should trouble adjacent components.

DEFAULT SOURCE SETTINGS

The following table lists the default SOURCE settings. Note that the Audio input settings show both digital and analog audio input. Digital input will always take precedence over analog audio input even if both are present.

SOURCE	AUDIO INPUT	VIDEO INPUT
Source 1	HDMI 1/Audio 1	HDMI 1
Source 2	HDMI 2/Audio 2	HDMI 2
Source 3	HDMI 3/Audio 3	HDMI 3
Source 4	HDMI 4/Audio 4	HDMI 4
Source 5	HDMI 5/Audio 5	HDMI 5
Source 6 (BluOS)	BluOS	BluOS
Source 7	7.1 Channel Input	Off
Source 8 (Front Input)	HDMI Front/Audio Front	HDMI Front
Source 9 (Media Player)	Front Media Player	Off

To modify the above default settings and for a better understanding of source setting and combinations, please refer to the item about "SOURCE SETUP" in the "USING THE T 777 - SETUP MENU" segment of the "OPERATION" section.

NOTE

Digital input will always take precedence over analog audio input even if both are present.

IDENTIFICATION OF CONTROLS

FRONT PANEL

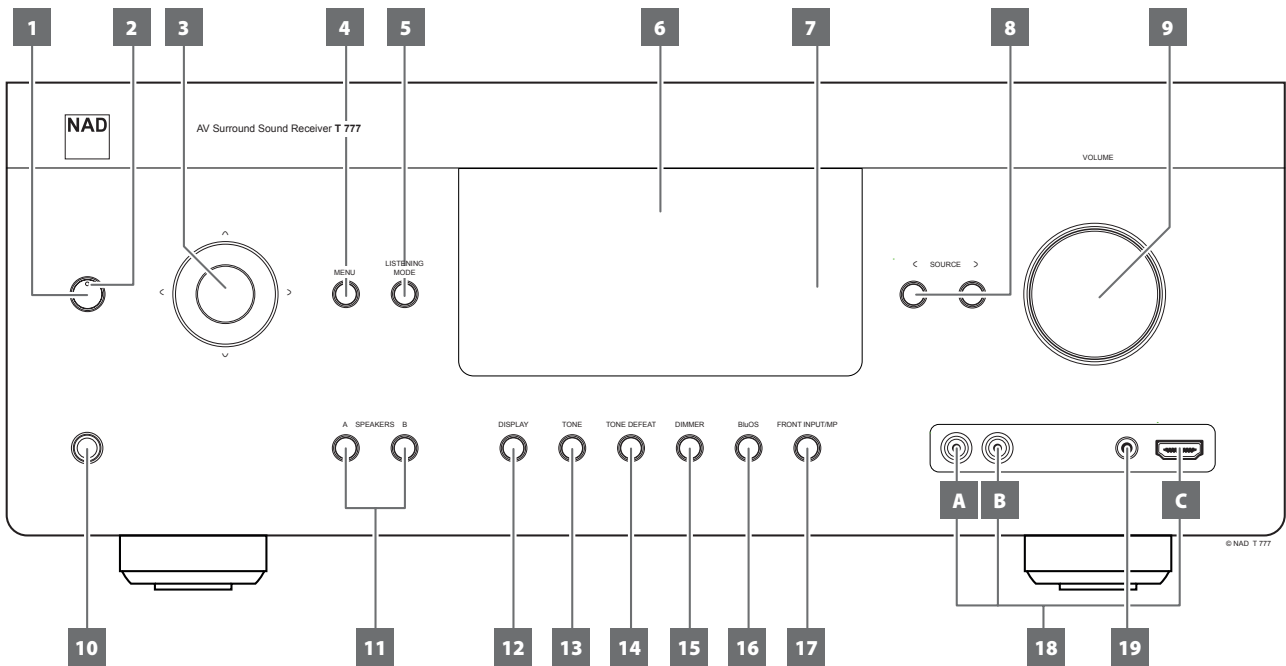

1 STANDBY BUTTON

- Press this button to switch ON the T 777 from standby mode. The Standby LED indicator will turn from amber to blue and illuminate the VFD. Pressing the STANDBY button again turns the unit back to standby mode.
- The T 777 can also be switched ON from standby mode by pressing any of the front panel buttons.

NOTE

In order to turn ON the T 777 from standby mode or back to standby mode, the rear panel POWER switch must be in the ON position.

2 STANDBY LED

- This indicator will light up amber when the T 777 is at standby mode.
- When T 777 is powered up from standby mode, this indicator will illuminate blue.
- If a Zone (Zone 2, Zone 3 or Zone 4) is ON and STANDBY button is pressed to switch the T 777 to standby mode, the VFD will be extinguished but the STANDBY LED remains illuminated blue. This indicates a Zone (Zone 2, Zone 3 or Zone 4) is still active. The corresponding active Zone icon(s) will also remain displayed in the VFD.
- In order to completely shut down the T 777 with Zone 2, Zone 3 and/or Zone 4 still ON, press and hold STANDBY button until the STANDBY LED turns amber.
- When infrared command from the HTR 8 is received, this indicator will also flash momentarily.

3 NAVIGATION and ENTER BUTTONS

- The navigation [↑/↓/←/→] and [ENTER] buttons have various applications specific to given modes. The middle round button is designated as [ENTER] button; this is normally pressed to complete a selection, procedure, sequence or other applicable functions.

4 MENU

- Press to activate or deactivate OSD menu.

5 LISTENING MODE

- Toggle to select through the various Listening mode options. Depending upon the format of the currently selected input (digital or analog, stereo or multichannel), various listening modes are available.
- Refer also to the item about LISTENING MODE under the USING THE T 777 – MAIN MENU segment of the OPERATION section.

6 VACUUM FLUORESCENT DISPLAY (VFD)

- Displays visual information about the current settings like the active Source, volume level, listening mode, audio format and other related indicators.
- Refer also to the item about FRONT PANEL DISPLAY SETUP under the USING THE T 777 - SETUP MENU segment of the OPERATION section.

7 REMOTE SENSOR

- Point the HTR 8 remote control at the remote sensor and press the buttons.
- Do not expose the remote sensor of the T 777 to a strong light source such as direct sunlight or illumination. If you do so, you may not be able to operate the T 777 with the remote control.

Distance: About 23ft (7m) from the front of the remote sensor.

Angle: About 30° in each direction of the front of the remote sensor.

8 < SOURCE >

- Toggle < SOURCE or SOURCE > to select desired Source. Press repeatedly either button until desired source is selected.
- Refer also to the item about SOURCE SETUP under the USING THE T 777 - SETUP MENU segment of the OPERATION section.

9 VOLUME

- The VOLUME control adjusts the overall loudness of the signal driving the loudspeakers or headphones.
- Turn clockwise to increase the volume level; counter clockwise to lower it.

10 PHONES

- Accepts stereo headphone using a standard 1/4-inch stereo phone plug (use a suitable adaptor for headphones equipped with a smaller plug).
- For headphone listening, the Front speakers must be set to "Large" at the "Speaker Configuration" of the Speaker Setup item at the Setup Menu; otherwise headphone bass response will be restricted.

11 A SPEAKERS B

- Press Speaker A, B or both to select the set of speakers you wish to listen to.
- Press Speaker A or B to turn on or off applicable speaker.
- Speaker A is the main set of 7 multichannel and surround speakers.
- Speaker B is an auxiliary set for remote locations such as other rooms of your home. For Speaker B selection, all surround sound sources are down mixed to stereo. Combining Speaker A and Speaker B (SPEAKERS A + B) will also result to the source being down mixed to stereo.

12 DISPLAY

- Information is displayed as supplied by the applicable source.
- Supplied information is displayed by repeatedly pressing [DISPLAY] button.

13 TONE

- Press to adjust TREBLE control using the VOLUME knob over a ± 10 dB range. Press again to adjust BASS control and a third time for DIALOG control.
- Refer also to the item about TONE CONTROLS under the USING THE T 777 – MAIN MENU segment of the OPERATION section.

14 TONE DEFEAT

- Tone Controls are enabled or disabled by pressing this button. Tone controls are bypassed at "Tone Defeat" while at "Tone Active", the tone controls are enabled again.
- Refer also to the item about TONE CONTROLS under the USING THE T 777 – MAIN MENU segment of the OPERATION section.

15 DIMMER

- Brightness level of front panel display switches between normal and dim.

16 BluOS

- BluOS Setup Menu is activated.

17 FRONT INPUT/MP

- Source is switched between Front Input and Media Player.

18 FRONT INPUT PORTS

- Use these convenience jacks for occasional sources such as any analog audio or HDMI sources.
- If your source has a single audio out jack only or is marked "Mono output", plug this into the T 777's Front "R (MONO)" input (item B).
- On the other hand, if your source has two output jacks indicative of stereo output, insert both jacks into the T 777's corresponding Front "L" (item A) and "R (MONO)" input to achieve stereo output as well.
- Use the front HDMI input (item C) to connect directly an HDMI output source.

19 FRONT INPUT FOR MEDIA PLAYER

- Connect your Media Player's standard stereo phone jack to this input.

IDENTIFICATION OF CONTROLS

REAR PANEL

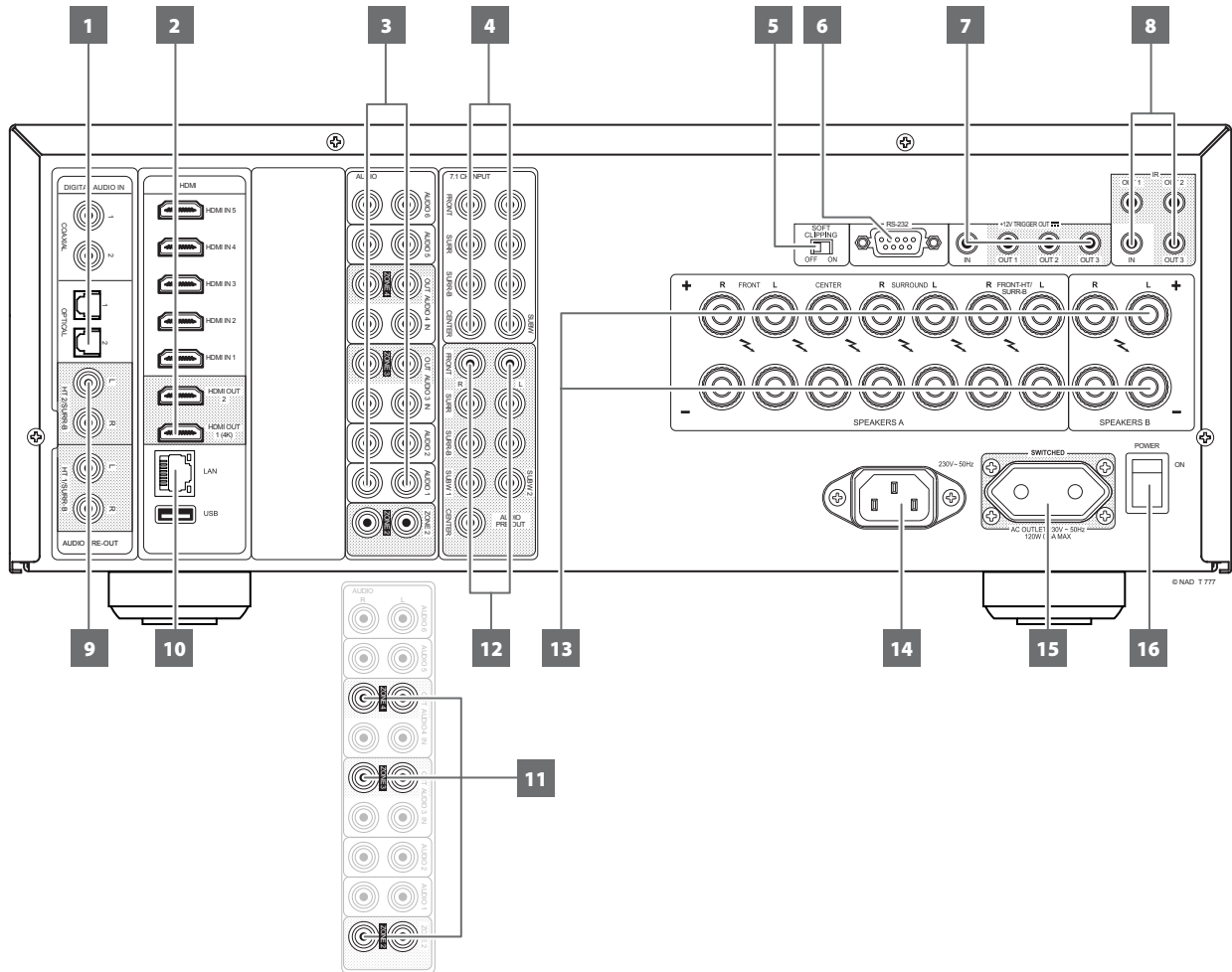

ATTENTION!

Please make sure that the T 777 is powered off or unplugged from the mains power source before making any connections. It is also advisable to power down or unplug all associated components while making or breaking any signal or AC power connections.

1 DIGITAL AUDIO IN (COAXIAL 1-2, OPTICAL 1-2)

- Connect to corresponding optical or coaxial output of sources such as CD or BD/DVD players, digital cable box, digital tuners and other applicable types of equipment.
- Coaxial and optical digital input association is configurable via the Source Setup item of the Setup Menu On-Screen-Display (OSD).

2 HDMI (HDMI 1-5, HDMI 1-2 OUT)

- Connect HDMI 1-5 to various HDMI OUT connectors of source components such as DVD player, BD player, HDTV satellite/cable box and other applicable types of equipment.
- Connect HDMI 1-2 OUT to HDTVs or projectors with HDMI input. HDMI 1 OUT supports 4K@60 4:4:4 and HDCP 2.2 compliant. Both HDMI output ports display simultaneously the same audio/video source.

WARNING

Before connecting and disconnecting any HDMI cables, both the T 777 and the ancillary source must be powered OFF and unplugged from the AC outlet. Failure to observe this practice may cause permanent damage to all types of equipment connected via HDMI sockets.

3 AUDIO 1-6

- These comprise the T 777's other sets of principal input. Connect these analog audio input ports to the corresponding audio output ports of source components such as CD players or other line level audio sources.

AUDIO 3-4 OUT

- Connect AUDIO 3 OUT (and/or AUDIO 4 OUT) to corresponding recording components or audio input ports of compatible sources like CD/DVD recorder or outboard audio processors.
- The signal present at AUDIO 3-4 OUT is determined by the current source selected. There will be no output at AUDIO 3 OUT when AUDIO 3 is selected. Likewise, there will be no output at AUDIO 4 OUT when AUDIO 4 is the active source input. This prevents feedback through the recording component thereby preventing possible damage to your speakers.
- When configured, AUDIO 3 OUT and AUDIO 4 OUT are the same assigned ports for Zone 3 and Zone 4 respectively. Refer also to item 11 about ZONE 2-3-4.

4 7.1 CH INPUT

- Connect to corresponding analog audio output of a multichannel source component such as DVD-Audio or multichannel-SACD player or external multichannel decoder (disc copy protected formats only allow analog signal transfer). Typically, these sources will produce 5.1-channel output, in which case the Surround Back jacks are left unconnected. The signal present at these jacks can be heard by selecting Source 7 (7.1 CHANNEL INPUT is defaulted to this Source).
- There is no bass-management or other processing (other than master-volume control) available to this 7.1 channel input.
- While the multichannel audio output of a DVD/BD player can be connected to these jacks, using the T 777's own Dolby Digital and DTS decoding and digital-analog converters via a digital connection will usually produce superior results.

5 SOFT CLIPPING

- Enables NAD's proprietary Soft Clipping circuitry on all channels.
- At ON position, Soft Clipping gently limits the output of the T 777 to minimize audible distortion should the T 777 be over-driven.
- Soft Clipping may simply be left ON at all times to reduce the likelihood of audible distortion from excessive volume settings. However, for critical listening and to preserve optimum dynamics, you may wish to defeat it by setting this switch to OFF.

6 RS 232

- NAD is a certified partner of AMX and Crestron and fully supports these external devices. Check out the NAD website for information about AMX and Crestron compatibility with NAD. See your NAD audio specialist for more information.
- Connect this interface using RS-232 serial cable (not supplied) to any Windows compatible PC to allow remote control of the T 777 via compatible external controllers.
- Refer to the NAD website for information about RS232 Protocol documents and PC interface program.
- Use this port also for firmware upgrade. Instructions on how to use this port for firmware upgrade is included in the firmware upgrade (if any) procedure available from the NAD website.

7 +12V TRIGGER OUT

- The T 777 has three +12V TRIGGER OUT ports (OUT 1, OUT2 and OUT3) that can be configured to supply +12V DC to a linked component or system. See discussion on "Trigger Setup" at the "Setup Menu" literature for guidelines on how to configure +12V TRIGGER IN/OUT.
- Use a 3.5mm mini-jack connector to pass +12 volts at a maximum current of 50 milliamps to an auxiliary equipment such as multichannel amplifier or subwoofer. The center conductor (hot) of the 3.5mm jack is the control signal. The outside conductor (shield) is the ground return-path.
- This output will be 12V when the T 777 is ON and 0V when the unit is either OFF or in standby mode.

+12V TRIGGER IN

- With this input triggered by a 12V DC supply, the T 777 can be switched ON remotely from standby mode by compatible devices such as amplifiers, preamplifiers, receivers, etc. If the 12V DC supply is cut off, the T 777 will return to standby mode.
- Connect this +12V Trigger input to the remote device's corresponding +12V DC output jack using a mono cable with 3.5mm male plug. The controlling device must be equipped with a +12V trigger output to use this feature.

8 IR IN/IR OUT 1-3

- These mini-jacks accept and output remote-controlled codes in electrical format, using industry-standard protocols, for use with "IR-repeater" and multi-room systems and related technologies.
- All NAD products with IR IN/IR OUT features are fully compatible with the T 777. For non-NAD models, please check with your other product's service specialists as to their compatibility to the T 777's IR features.

IR IN

- This input is connected to the output of an IR (infrared) repeater (Xantech or similar) or the IR output of another compatible device to allow control of the T 777 from a remote location.

IR OUT 1, IR OUT 2

- Connect IR OUT 1 (and/or IR OUT 2) to the IR IN jack of a compatible device.
- Command and control the linked compatible device by directing its own remote control to T 777's infrared receiver.

IR IN and IR OUT 1, IR OUT 2, IR OUT 3

- Connect the T 777's IR IN to the IR OUT of a compatible device. Connect also the T 777's IR OUT 1 (and/or IR OUT 2, IR OUT 3) to the IR IN of a compatible device.
- With this setup, the T 777 acts as an "IR-repeater" allowing the device connected to the T 777's IR IN control or command of the other device linked to T 777's IR OUT 1 (and/or IR OUT 2, IR OUT 3).

IR OUT 3

- IR OUT 3 can only function as an "IR-repeater" as described above.

9 HT 2/SURR-B HT 1/SURR-B

- Connect HT 2/SURR-B and/or HT 1/SURR-B to the audio input of an external power amplifier hooked up with up to 4 Height speakers.

10 ETHERNET/LOCAL AREA NETWORK (LAN) PORT

- LAN connection must be setup for wired connection to be established. Set up a Wired Ethernet broadband router with broadband internet connection. Your router or home network should have a built-in DHCP server to consummate the connection.
- Using a standard straight-through Ethernet cable (not supplied), connect one end of the Ethernet cable to the LAN port of your wired Ethernet broadband router and the other end to T 777's LAN port.
- This Ethernet connection has similar function as that of the RS232 connection. With your PC and the T 777 on the same network, it allows remote control of the T 777 via compatible external controllers.
- With your PC and T 777 connected on the same network, the IP address of your T 777 can be obtained. Press together and then release the front panel buttons [◀ SOURCE] and [SOURCE ▶] - "System Info" is shown in the VFD and OSD. Toggle [↖] or [↘] to individually show in the VFD the "System Info" details which include the IP address.

NOTES

- *NAD is not responsible for any malfunction of the T 777 and/or the internet connection due to communication errors or malfunctions associated with your broadband internet connection or other connected equipment. Contact your Internet Service Provider (ISP) for assistance or the service bureau of your other equipment.*
- *Contact your ISP for policies, charges, content restrictions, service limitations, bandwidth, repair and other related issues pertinent to internet connectivity.*

IDENTIFICATION OF CONTROLS

REAR PANEL

USB

- Connect the USB connector of the supplied BluOS/USB hub to this USB input. Ensure that the Wi-Fi dongle and Bluetooth USB Micro Adaptor are securely connected to any of the 4 ports of the USB hub. If wireless connectivity is poor, connect Wi-Fi dongle to the supplied extension cable and straighten out for better reception.
- Refer also to instructions on HOW TO SETUP WIRELESS CONNECTION in the BluOS SETUP menu.

11 ZONE 2-3-4

- The T 777 has three configurable Zones – Zone 2, Zone 3 and Zone 4. The Zone feature allows one to simultaneously experience in a different zone or location of the house a Source assigned to a particular zone.
- Zone selected audio source is sent to the corresponding audio input of another zone. Use high quality patch cables to reduce noise pickup over long distance runs.
- For a better understanding of zone settings, study below the section about "Zone Controls" of the "Main Menu" discussion as well as the item about "Zone Setup" under the "Setup Menu" literatures.

12 AUDIO PRE-OUT

- AUDIO PRE- OUT makes it possible to use the T 777 as a preamplifier to external power amplifiers for some or all channels.
- Connect FRONT L, FRONT R, CENTER, SURR R, SURR L, SURR-BL and SURR-BR to the respective channel input of a power amplifier or amplifiers driving the corresponding applicable speakers.
- Connect the SUBW1 (and/or SUBW2) output to powered ("active") subwoofers or to power amplifier channels driving a passive system.
- Unlike the full range channels, there is no power amplifier built-into the T 777 for a subwoofer.

ZONE 2-3-4/HEIGHT 1/HEIGHT 2

- SURR BL and SURR BR are also assigned as secondary ZONE 2, ZONE 3, ZONE 4, HEIGHT 1 or HEIGHT 2 audio pre-out. This is applicable if Zone 2, Zone 3, Zone 4, Height 1 or Height 2 is the selected setting of "Back Amplifier" in the "Amplifier Setup" menu.
- Refer also to the item about AMPLIFIER SETUP below.

13 SPEAKERS A, SPEAKERS B

- Connect the respective SPEAKER A's FRONT L, FRONT R, CENTER, SURR R, SURR L, SURR-BL and SURR-BR channels to their corresponding loudspeakers. Make sure the "+" (red) terminal and "-" (black) terminal are connected to the corresponding "+" and "-" terminals of the loudspeaker. Use extra care to ensure that no stray wires or strands cross between posts or terminals at either end.
- Connect left and right channels of SPEAKERS B to corresponding remote loudspeakers. When SPEAKERS B is activated, the output is converted to "Stereo Downmix". Combining SPEAKER A and SPEAKER B (SPEAKERS A + B) will also result to the source being down mixed to stereo.
- The T 777 is designed to produce optimum sound quality when connected to speakers with impedances within its operating range. Please make sure that all the speakers are rated 4Ω minimum per speaker.

ZONE 2-3-4/HEIGHT 1/HEIGHT 2

- SURR-BL and SURR-BR can also be assigned as ZONE 2, ZONE 3, ZONE 4, HEIGHT 1 or HEIGHT 2 speaker level output. This is applicable if Zone 2, Zone 3, Zone 4, Height 1 or Height 2 is the selected setting of "Back Amplifier" in the "Amplifier Setup" menu.

NOTE

Use stranded wire of at least 16 gauge (AWG). Connections to the T 777 can be made with banana plugs (120V version only) or by using bare wire or pins. Use the transverse hole through the post for bare-wire or pin connections. By loosening the terminal's plastic nut, make a clean, neat connection and re-tighten carefully. To minimize the danger of short-circuit, ensure that only 1/2-inch of exposed wire or pin is employed when connecting.

14 AC MAINS INPUT

- The T 777 comes supplied with a separate detachable mains power cord. Before connecting the plug to the mains powers source, connect firmly first the other end to T 777's AC Mains input socket.
- Always disconnect the mains power plug from the mains power source first, before disconnecting the cable from the T 777's AC Mains input socket.
- Connect only to the prescribed AC outlet, i.e., 120V 60 Hz (for 120V version models only) or 230V 50 Hz (for 230V version models only).

15 SWITCHED AC OUTLET

- This convenience outlet can supply switched power to another component or accessory.
- The total draw of all devices connected to this outlet must not exceed 120 watts.
- It is powered ON and OFF by the front panel STANDBY button or by the HTR 8's ON and OFF keys.

16 POWER

- AC mains power is supplied to T 777.
- When the POWER switch is set to ON position, the T 777 goes to standby mode as shown by the amber status condition of the Standby LED. Press the front panel Standby button or HTR 8 remote control's [ON] button to switch ON the T 777 from standby mode.
- If you intend not to use the T 777 for long periods of time (such as when on vacation), switch off the POWER switch.
- With POWER switched off, neither the front panel Standby button nor HTR 8 remote control's [ON] button can activate the T 777.

ABOUT THE ON-SCREEN DISPLAY (OSD)

The T 777 employs a simple, self-explanatory system of on-screen display “menus” that will appear on the connected video monitor/TV. These are required during the setup process (and are useful in day-to-day operation), so be sure to connect the monitor/TV before proceeding with setup.

DISPLAY THE OSD

Press [D], [D], [MENU] or [ENTER] buttons of the HTR 8 remote control or front panel to display the T 777's Main Menu on your video monitor/TV. If the OSD does not appear, check your MONITOR OUT connections.

IMPORTANT

The OSD can only be viewed using a display device with minimum 1080p resolution.

NAVIGATING THE OSD AND MAKING CHANGES

To navigate through the OSD menu options, please do the following using the HTR 8 or corresponding front panel buttons:

- 1 Press [D] to select a menu item. Use [▲/▼] or in some cases, [ENTER], to move up or down the Menu selections. Repeatedly press [D] to advance or go further into the sub-menu of desired menu item.
- 2 Use [▲/▼] to set or change the parameter value (setting) of a menu item.
- 3 Press [C] to save the settings or changes done on the current menu or sub-menu. Pressing [C] will also return the user to the previous menu or exit from a particular menu.

MAIN MENU

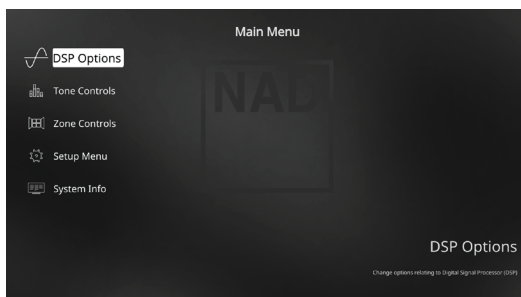

The Main Menu contains the menu options for “DSP Options”, “Tone Controls”, “Zone Controls”, “System Info” and access to “Setup Menu”.

Follow the guidelines about “DISPLAY THE OSD” and “NAVIGATING THE OSD AND MAKING CHANGES” to navigate through the menu options and their sub-menu selections.

NOTE

The individual configurations set forth at “DSP Options” and “Tone Controls” are carried over whenever they are enabled at A/V Presets setting. Please see the section “AV PRESETS” for reference.

DSP OPTIONS

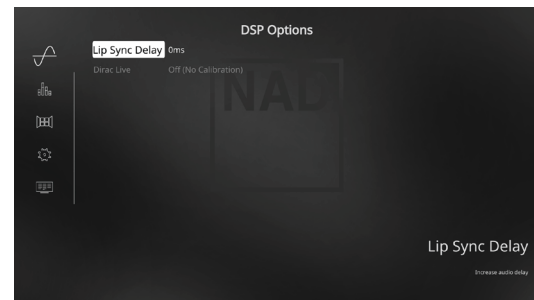

The following signal processing parameters can be setup under the DSP (Digital Signal Processing) Options menu.

LIP SYNC DELAY

DSP Options has the feature ‘Lip Sync Delay’ whose function is to match any delay that may occur in the picture relative to the audio.

By varying ‘Lip Sync Delay’ from 0ms to 120ms, one can delay the audio output in order to synchronize it with the video image.

OPERATION

USING THE T 777 – MAIN MENU

TONE CONTROLS

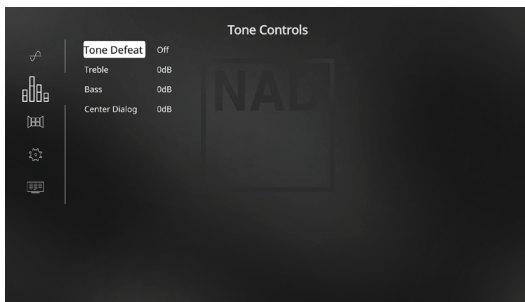

The T 777 has three Tone Control levels – Treble, Bass and Center Dialog. Bass and Treble controls only affect the low bass and high treble leaving the critical midrange frequencies free of coloration. The Center Dialog ('Dialog' in the VFD) control boosts the 'presence' of the midrange region improving intelligibility of speech.

These controls allow one to tweak on-the-fly, the frequency response of the source during playback. The control setting could be adjusted by navigating through the Tone Controls' OSD menu via a combination of [ENTER] and [▲/▼] keys. The same can be managed directly by pressing the front panel's TONE button and then rotating the VOLUME knob to select desired setting.

Maximum and minimum values for all three Tone Control levels are ± 10 dB.

'Tone Defeat' gives one the choice of varying or completely bypassing the tone control section of the T 777. If 'Off' ('Tone Active' in the VFD) is selected, the Tone Control circuits are active.

Select 'On' ('Tone Defeat' in the VFD) to bypass the Tone Controls effectively defeating the effect of the tone control circuits.

NOTE

Tone Controls options can be directly selected or changed using HTR 8's [TONE] button with DEVICE SELECTOR set to AMP mode. Refer to front panel display to manage tone controls. Toggle [TONE] button to select "Treble", "Bass" or "Dialog" and then use the [▲/▼] to adjust their respective levels. Press [TONE] again to save the settings and at the same time move on to the next parameter or exit the parameter setting altogether.

ZONE CONTROLS

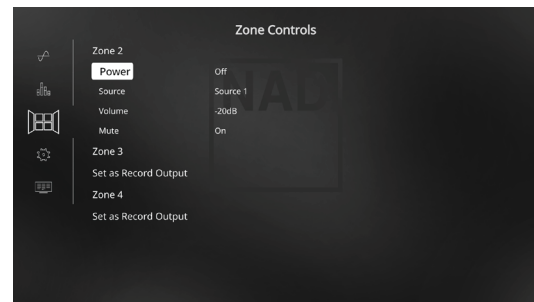

Depending on the settings made at the separate 'Zone Setup' menu under the 'Setup Menu' section discussion, the applicable Zone can be configured and managed via this 'Zone Controls' window.

Select 'On' to activate the applicable Zone. When activated, the Source input for the particular Zone can be allocated by selecting through the following inputs – All enabled analog Sources, Front Input, Media Player and Local.

Select 'Local' as your selected Zone's Source input if you wish to enjoy the same source as the main Zone and allow simultaneous listening, but with full separate volume levels.

If a Zone is set to 'Off', it is deactivated or powered off.

'Volume' refers to the adjustable secondary Zone Volume level that can be increased or decreased using the ▲/▼ buttons of the HTR 8 or front panel's corresponding navigation buttons.

When a Zone is activated, a corresponding Zone number is illuminated at the VFD. Zone 2 is always available to be configured at 'Zone Controls' menu. For Zone 3 and Zone 4 to become available at the 'Zone Controls' window, their corresponding 'Mode' in the 'Zone Setup' menu under the 'Setup Menu' section should be set to 'Zone'.

NOTE

The ZR 7 remote control will only control Zone 2 applications. Zone 3 and Zone 4 could be configured and managed at the appropriate Zone OSD menu using the front panel navigations buttons as well as the corresponding keys on the HTR 8 remote control.

IMPORTANT NOTICE

- Only analog audio connected through a Source's analog audio input port can be associated as audio source for Zone 2, Zone 3 or Zone 4.
- Digital audio sources connected via HDMI, digital optical and digital coaxial input ports cannot be downmixed and used as Zone 2, Zone 3 or Zone 4 audio source.
- BluOS audio is also not applicable as a Zone 2, Zone 3 or Zone 4 audio source.
- Ensure that the associated Source's Digital Audio setting is set to "Off" or no actual digital source is connected.

SYSTEM INFO

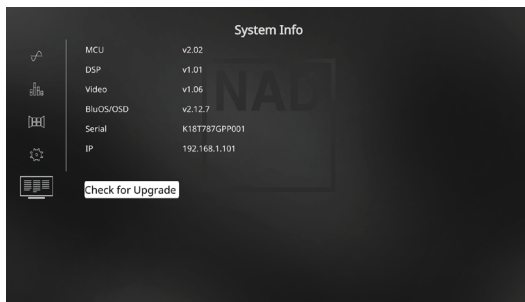

“System Info” displays information about current firmware versions of MCU, DSP, Video and BluOS/ OSD as well the unit’s serial number and IP address. The System Information shown above is for reference only.

CHECK FOR UPGRADE

Your T 777 is updated to latest firmware versions if “Check for Upgrade” is shown.

SYSTEM INFO (UPGRADE AVAILABLE)

Your T 777 needs to be upgraded if the “System Info” item in the Main Menu changes to “System Info (Upgrade Available).”

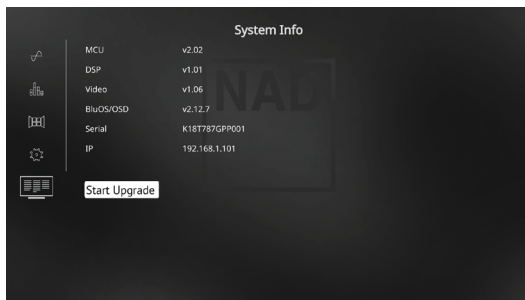
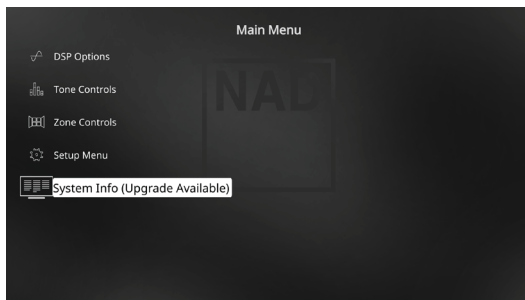

START UPGRADE

With your T 777 connected to internet, select “Start Upgrade” and Internet Update will proceed automatically.

Refer also to enclosed INTERNET UPDATE GUIDELINES for further guidelines.

SETUP MENU

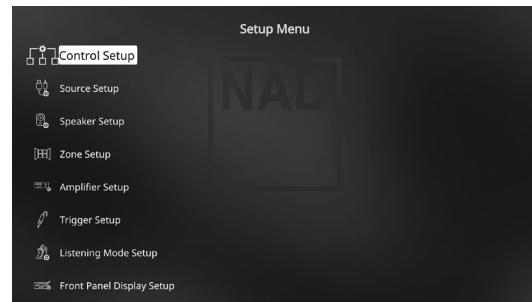

The Setup Menu allows one to customize the operation of the T 777 to the ancillary equipment used in one’s specific AV system. Unless your system exactly matches the factory defaults as shown in the accompanying Quick Start Guide, you will need to use the setup menu to configure the inputs of the T 777.

At Setup Menu, the following are configurable

- Control Setup
- Speaker Setup
- Amplifier Setup
- Listening Mode Setup
- A/V Presets
- Select Language
- Source Setup
- Zone Setup
- Trigger Setup
- Front Panel Display Setup
- BluOS Setup

To access and navigate through Setup Menu and its sub-menu selections, please refer to and follow the directions stated in the sections ‘Display the OSD’ and ‘Navigating the OSD and Making Changes.’

CONTROL SETUP

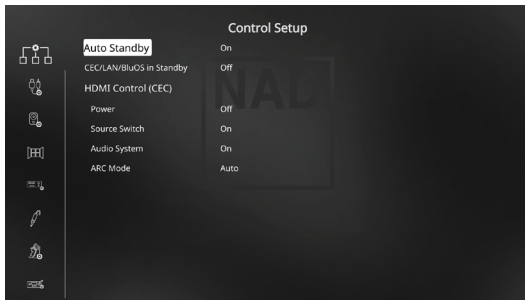

The T 777 supports HDMI Control (CEC) and Audio Return Channel (ARC) functions. Both functions are possible if external devices that also support both features are interconnected with the T 777 via HDMI connection.

AUTO STANDBY

The T 777 can be setup to automatically go to standby mode if there is no user interface interaction within 30 minutes.

- On:** T 777 will go to standby mode automatically in the absence of any user interface interaction within 30 minutes.
- Off:** T 777 remains active even though no user interface interaction is detected.

CEC/LAN/BLUOS IN STANDBY

Indicate the status of CEC, LAN and BluOS activity while the unit is at standby mode.

- On**
 - Enable CEC feature. Audio and video will continuously stream from a CEC-enabled HDMI source to a CEC-enabled TV (with both devices connected via T 777).
 - LAN and BluOS connections continue to be active.
- Off**
 - T 777 will not pass through any CEC message. Audio and video will not be streamed from a CEC-enabled HDMI source to a CEC-enabled TV (with both devices connected via T 777).
 - LAN and BluOS connections are idle or inactive.

HDMI CONTROL (CEC)

Consumer Electronics Control (CEC) is a set of commands that utilizes HDMI's two-way communication to allow for single remote control of any CEC-enabled devices connected with HDMI. A CEC command will trigger the necessary commands over HDMI for an entire system to auto-configure itself to respond to the command.

When devices that support HDMI Control (CEC) are connected, the following modes of operation can be executed via the T 777 or the external device using any of the device's remote control.

Off: Applies to all CEC options below. At "Off" setting, particular CEC feature is defeated.

Power Off: At "On" setting, the T 777 will automatically go to standby mode if it receives a CEC standby command. On the other hand, if the T 777 receives a CEC power up command, the T 777 will correspondingly switch ON from standby mode.

Source Switch: At "On" setting, the T 777 will automatically switch sources if another CEC device requests a Source change.

For example, if PLAY is pressed on a BD Player with CEC, the T 777 and TV with CEC will automatically switch to their respective input connections – the T 777 switching to the HDMI input where the BD Player is connected while the TV will switch to its input where the T 777's HDMI OUT is connected. This completes the auto-configuration – the BD Player is automatically played back using the T 777 and TV.

Audio System: At "On" setting, the T 777 will broadcast a CEC message indicating it is an active audio system. A CEC compatible TV will usually mute its audio output when this happens. When this option is enabled, the T 777 will also respond to CEC volume and mute commands. For example, a CEC TV may forward the volume commands from its remote to the T 777.

ARC Mode: Audio Return Channel (ARC) enables an ARC-enabled TV to send audio data "upstream" to T 777.

This option has three choices: Off, Auto or Source Setup.

Auto: When set to Auto, the T 777 will automatically attempt an ARC audio connection to the TV whenever the TV announces over CEC that it has become the active source. If an ARC connection can be established, the T 777 will output the ARC audio signal no matter what source is selected on the T 777 and will show "HDMI ARC" on the VFD. The Auto option tends to work best when all your devices support CEC and the Source Switch option is set to On.

Source Setup: When set to Source Setup, you can select "ARC" for the digital audio input in the source setup screen. When you select a source on the T 777 which is set for ARC, the T 777 will attempt to initiate an ARC connection with the TV. When using this option, you would probably also want to make sure Source Switch is off otherwise other CEC devices may keep changing the T 777 source when you want it to remain on the ARC source.

IMPORTANT NOTES

- "Audio System" must be set to "On" for "ARC mode" to manifest as an option.
- "CEC/LAN/BluOS in Standby" must be set to "On" for audio and video to continuously stream from a CEC-enabled HDMI source to a CEC-enabled TV (with both devices connected via T 777).

SOURCE SETUP

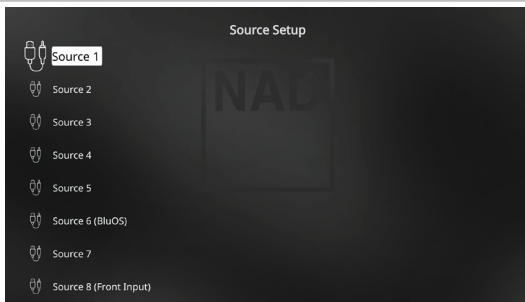

The Source Setup menu makes it possible to set, allocate or change the Sources settings. The T 777 Sources are all configurable. Each Source can be configured with respect to the following settings.

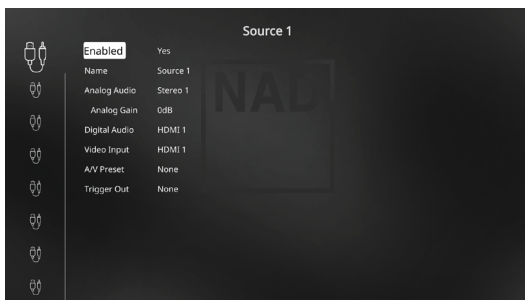

ENABLED

One can enable/disable a Source via this option. This is particularly useful if only few Sources are used and one directly selects the Source from the front panel, bypassing unused sources.

Select "Yes" to enable the particular Source or "No" to disable the Source.

NAME

A new Name maybe assigned to a Source label. For example, if your BD player is attached to "Source 1", it is possible to rename "Source 1" to "BD".

In order to rename the Source label, scroll to the "Name" parameter. Press [D] to go to the first character. Then, press [▲/▼] to pick through the alphanumeric selections.

Press [D] to move to the next character and at the same time save the changes done on the current character. The name can be as long as twelve characters.

The new Name will be shown in the VFD as well as on the OSD.

ANALOG AUDIO

The T 777 has nine analog audio inputs including 7.1 input. These analog inputs (Stereo 1, Stereo 2, Stereo 3, Stereo 4, Stereo 5, Stereo 6, Stereo Front, Media Player (Front) and External 7.1) can be variably assigned to each Source.

"External 7.1" selects audio input signal from "7.1 CH INPUT".

If "Off" is selected, no incoming analog audio signal is selected by the particular Source.

NOTE

An incoming digital signal present at the assigned digital input will always take precedence over the assigned analog audio input, even if both are present. To maintain the analog audio input for the particular Source, select "Off" at the "Digital Audio" setting of the same "Source" menu.

ANALOG GAIN

Gain adjustment allows all sources to play back at the same volume level so you don't need to adjust the volume every time a new source is selected. It is generally preferable to reduce the level of the loudest source rather than making louder the softer sources.

Scroll to "Analog Gain", press [D] and then [▲/▼] to step through the desired level from -12dB to 12dB.

DIGITAL AUDIO

To take advantage of the T 777's high performance surround and digital audio circuitry, it is advisable that its sets of Digital Audio input are selected.

There are various types of Digital Audio input for the T 777. These are HDMI, BluOS, Optical and Coaxial digital input. Another option is "Off" whereby no incoming digital audio signal is selected by the particular Source.

The following are the sets of assignable Digital Audio input:

HDMI → HDMI 1, HDMI 2, HDMI 3, HDMI 4, HDMI 5, HDMI Front

Optical → Optical 1, Optical 2

Coaxial → Coaxial 1, Coaxial 2

BluOS

NOTE

An incoming digital signal present at the assigned digital input will always take precedence over the assigned analog audio input, even if both are present. To maintain the analog audio input for the particular Source, select "Off" at the "Digital Audio" setting of the same "Source" menu.

OPERATION

USING THE T 777 – SETUP MENU

VIDEO INPUT

All six HDMI sources can be assigned as video input to a particular Source. Another option is "Off" wherein the particular Source is prompted not to select any Video input.

HDMI → HDMI 1, HDMI 2, HDMI 3, HDMI 4, HDMI 5, HDMI Front

Previous → Display or retain preceding video.

NOTE

The T 777 also supports HDMI features that include compatibility with a broad range of 3D and HD digital video sources and displays.

A/V PRESET

A particular Source can be assigned a stored Preset. The parameters set up in the selected Preset number will be adopted into the particular Source it is assigned (Please refer to the separate section on "A/V Presets" for further understanding of Preset settings).

If it is desired not to assign the particular Source a Preset setting, select "None".

TRIGGER OUT

Trigger Out feature for a particular Source is dependent upon the configurations done in a separate menu on Trigger Setup (See "Trigger Setup" below). If "Source Setup" is assigned to all three Trigger output (Trigger Out 1-3) in the separate "Trigger Setup" menu window, a particular Source can have the following Trigger Out combinations

Trigger Out: 1 → 2 → 1 + 2 → 3 → 1 + 3 → 2 + 3 → 1+2+ 3

These combinations are dependent upon the assignment of "Source Setup" for Trigger 1 Out, Trigger 2 Out or Trigger 3 Out at the "Trigger Setup" menu.

Another option is "None" whereby the particular Source is not assigned any Trigger Out.

For "Trigger Out" to become enabled and assignable at "Source Setup" menu, make sure to carry out or note the following beforehand

- In the separate "Trigger Setup" menu, assign Trigger 1 Out, Trigger 2 Out or Trigger 3 Out to "Source Setup."
- "Trigger Out" will not appear as an option at the Source Setup menu if at the separate "Trigger Setup" menu, Trigger 1 Out, Trigger 2 Out or Trigger 3 Out are all assigned to "Main, Zone 2, Zone 3, Zone 4, or Zone 2+3+4"; with not even one "Trigger Out" port allocated to "Source Setup."

SPEAKER SETUP

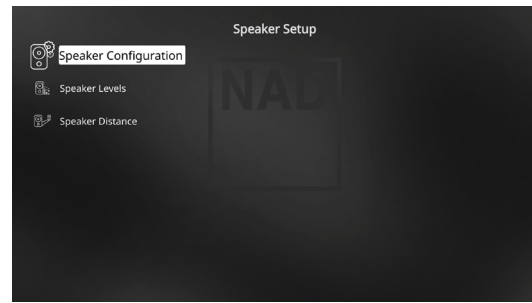

After connecting all ancillary sources and other combinations, the Speaker Setup menu will guide you on how to manage and setup your speakers in order to achieve optimum sound acoustics in your listening environment.

The following are the Speaker Setup Menu sections.

SPEAKER CONFIGURATION

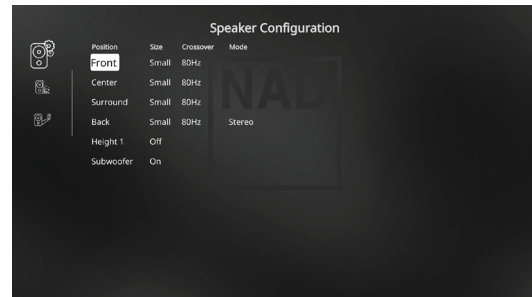

Every surround-sound system requires "bass-management" to direct low-frequency content from any or all channels to the speakers best able to reproduce it. For this function to operate correctly, it is important that you correctly identify your speakers' capabilities. We use the terms "Small" and "Large" (and "Off") but note that physical size may be irrelevant.

- A "Small" speaker is any model, regardless of physical size, that lacks significant deep-bass response, that is, below about 200 Hz.
- A "Large" speaker is any full-range model; that is, one with deep-bass response
- An "Off" speaker is one that is not present in your system. For example, you might not have any surround-back speakers installed; in that case, you would set the "Back" setup item to "Off". For "Height" speakers, selecting "Off" option for "Height 1" will automatically cut off both Height 1 and Height 2 Audio output.

The Speaker Configuration is "global"; that is, it remains in force with all input and listening modes. However, speaker settings are part of the T 777's Preset system. Consequently, multiple speaker settings can be stored for easy recall as different types of recordings or listening modes require.

Speaker Configuration can be managed and adjusted by pressing a combination of [D] and then [▲/▼] keys. Set "Front", "Center" and "Surround" to "Large", "Small" (40Hz to 200Hz) or "Off" as your subsystem's speakers require.

The "Back" speakers can either be one or two speakers. Set "Back" to either 1 or 2 speakers as per availability. Set "Subwoofer" to "On" or "Off" selecting "On" only if you have a subwoofer connected to the T 777's SUBW1 or SUBW2 output jack. If "Subwoofer" is set to "Off", "Front" speakers will automatically be set to "Large".

HEIGHT 1/HEIGHT 2

"Height 1" and "Height 2" AUDIO PRE-OUT can be connected to the audio input of an external power amplifier hooked up with up to 4 Height speakers. Height1/Height 2 settings must be set to "On" at the "Speaker Configuration" menu to power up the additional Height speakers.

ENHANCED BASS

When the subwoofer is set to "On" and "Front" is set to "Large", the option "Enhanced Bass" becomes available. Normally, with speakers set to "Large" the subwoofer is not active. The Enhanced Bass option allows full range operation of the speakers with the additional bass contribution of the subwoofer. This feature is particularly useful when one wants to experience maximum bass output. Please note that due to acoustic cancellation effects, the bass response may be uneven when using this setting

You can set Subwoofer to "On" even with "Large" front speakers, in which case bass content from any channels set to "Small" will be routed to both the subwoofer and to the front speakers; LFE-channel signal will pass only to the sub. In most subwoofer-equipped systems, setting front speakers to "Small" is usually the better option.

All the speakers' low frequency content can be directly adjusted within the range 40Hz to 200Hz.

NOTE

The configurations set forth at 'Speaker Setup' are carried over whenever it is enabled during A/V Preset setting. Please see also the section 'A/V Presets' for reference.

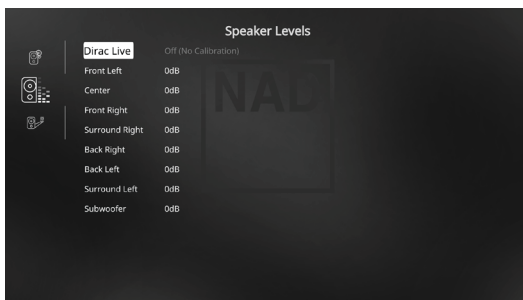
SPEAKER LEVELS

Adjusting the relative balance of your system's loudspeakers ensures that surround-sound recordings, whether music or film, will present the balance of effects, music, and dialog that the artists intended. Additionally, if your system incorporates a subwoofer it establishes a correct relationship between the volume of the subwoofer and the other speakers, and thus of low-frequencies (bass) to other sonic elements.

USING AN SPL METER

It is quite practical to perform the T 777 level setup routines "by ear," and careful work will produce acceptably accurate results. However, the use of an inexpensive sound-pressure level (SPL) meter, such as Radio Shack part number 33-2050, makes this task easier, more accurate and more repeatable. Ownership of such a meter could prove a valuable audio tool.

The SPL meter should be placed at the primary listening position, at approximately the height of the seated listener's head. A tripod is helpful but with a little duct tape almost anything — a pole lamp, music-stand, or ladder-backed chair, for example — can do as well. Just be sure that no large acoustically reflective surfaces obstruct or are near the microphone element.

Orient the meter with its microphone (usually at one end) pointing straight up toward the ceiling (not toward the speakers) and ensure that "C" weighting scale is selected. Set the meter to display 75 dB SPL. On Radio Shack meters, this necessitates either setting the meter to its 80 dB range and taking your readings at the -5 point or selecting the 70 dB range and reading at the +5 point.

SETTING SPEAKER LEVELS AT TEST MODE

While at 'Speaker Levels' menu, press the HTR 8 remote's [TEST] key activating the T 777's Speaker Levels balancing test signal. You will hear a "surf" sound as you step through your speakers ("Test Mode Active" is shown beside the Speaker Setup heading), beginning with the Front Left. If you do not hear the test signal, check your speaker connections or your 'Speaker Configuration' OSD menu settings.

Use the remote's [▲/▼] keys to adjust the loudness of the noise output from the currently playing channel to the required level (it's usually simplest to begin with the Front Left). As you cycle the test signal around the speakers, the OSD will highlight the currently playing channel. The "level offset" reading on the right will change by 1 dB increments; ±12 dB adjustment is available. Press 'ENTER' to adjust the next speaker.

NOTE

If you are balancing levels "by ear", choose one speaker—usually the center—as a reference and adjust each of the others in turn to "sound as loud" as the reference. Be sure that you remain in the primary listening position while balancing all channels.

To produce the same SPL meter reading (or subjective loudness), use the remote's [▲/▼] keys to adjust each speaker.

NOTES

- All speakers must be in their final locations before level-setting.
- Your subwoofer (if any) should be set with its integral crossover defeated, or if undefeatable, set to its highest-possible frequency if you are using the T 777's Subwoofer output. Final subwoofer-level adjustment "by-ear," using music and film sound material, is frequently useful.
- Due to the effects of room acoustics, matched-pair speakers (front; surround; back) will not always calibrate to exactly the same level offset readings.

You can exit 'Test' mode at any time by pressing [⏏] key, bringing you back to 'Speaker Setup' menu. You can also press the [TEST] key to discontinue the 'Test' mode.

OPERATION

USING THE T 777 – SETUP MENU

SPEAKER DISTANCE

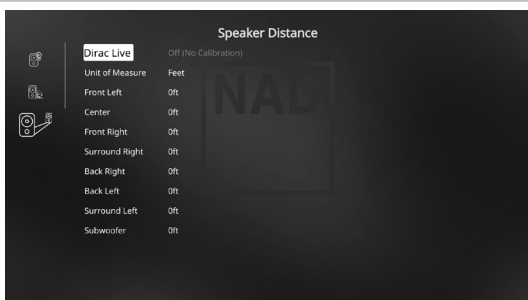

Your system's speaker distance settings are a subtle but important refinement of your setup. Informing the T 777 of the loudspeaker-to-listener dimensions of each speaker automatically imposes the correct delays, optimizing imaging, intelligibility and surround-sound ambience. Enter your dimensions with precision within about 1 foot (30 cm).

SETTING SPEAKER DISTANCE

While at 'Speaker Distance' menu, use the [▲/▼] keys to individually set each speaker distance as measured from the principal listening position to the front surface of the particular speaker. Distance can be displayed as feet or meters selectable at the 'Unit of Measure' item. Distance can be set up to 30 feet or 9.1 meters.

DIRAC LIVE

The proprietary Dirac Live is integrated with your T 777. Dirac Live® is a patented room correction technology that not only corrects the frequency response, but also the impulse response of a room's loudspeakers. Dirac Live provides true impulse response correction over a large listening area, improving the depth, positioning and distinction of individual voices and instruments. Using multiple measurement and mixed phase correction, Dirac Live helps create a natural, realistic and transparent sound with tighter bass and reduced room modes, in a way previously not possible.

Initiate Dirac Live by following below Setup Requirements.

T 777

- Update your T 777 to the latest firmware.
- Speaker Configuration must match actual speaker setup – turn off speakers that are not available.
- Both your computer and T 777 must be connected to the same network.

MICROPHONE

- The supplied measurement microphone can be connected to either the MIC or USB input of your computer or the USB input of the T 777.
- If the measurement microphone will be connected to the USB input of your computer or the T 777, ensure that the measurement microphone, phone jack adapter and USB Mic adapter are all connected together. The USB Mic adapter is not necessary if the measurement microphone will be connected to the MIC input of your computer,
- Minimize external noise such as talking, opening/closing of doors or windows and playback of sound during the measurement.
- Use a microphone stand to firmly place the microphone in the indicated measurement positions.

COMPUTER (WINDOWS, macOS)

- Both your computer and T 777 must be connected to the same network.
- Any active firewalls should allow HTTP (normal WWW access).
- Turn off any computer programs that may make any noise.
- Download the Dirac Live Calibration Tool™ installer.

Run the Dirac Live Calibration Tool™. Follow on-screen instructions. Refer also to the HELP window for more detailed instructions.

View and follow simulated Dirac Live Calibration at:
nadelectronics.com/dirac-live

For further information about Dirac Live Room Correction technology, visit:
www.dirac.com/live-home-professional-audio-info

ADJUSTING THE VOLUME

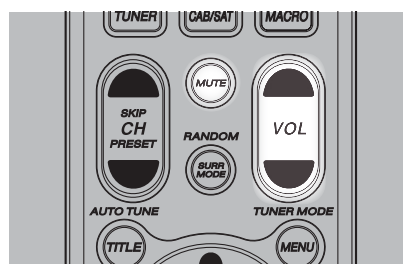

In addition to the Volume knob, use the HTR 8's [VOL ▲/▼] to adjust the "master volume" of the T 777 raising or lowering the channels altogether. A momentary keypress will change the master volume by 1 dB increments. If you hold down [VOL ▲/▼], the master-volume change will "run-on" until the key is released.

Since recordings vary considerably in overall average level, there is no imperative to listen at any particular master-volume setting. A setting of -20 dB may sound "as loud" from one CD or DVD as -10 dB does from another.

The T 777 will power-up from Standby mode at whatever master volume setting was last used; however, if the prior setting was greater than -20 dB, the T 777 will power up at -20 dB. This prevents inadvertently beginning a session at excessive volume.

MUTING THE SOUND

Use the HTR 8's [MUTE] key to silence all channels completely. Muting is always available regardless of the source or listening mode selections.

NOTES

- *Changing input or listening-mode selections does not release muting.*
- *Adjusting the volume level via the HTR 8 or the front panel volume knob will automatically release the mute function.*

ADJUSTING CHANNEL LEVELS 'ON THE FLY'

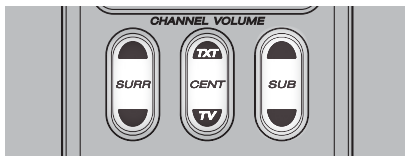

You can make changes to the relative levels of center, surround and subwoofer outputs without having to go into the 'Speaker Levels' menu. This is very convenient in circumstances like increasing (or tone down) a film's dialog level by raising (lowering) the center channel or reducing excessive deep bass (or enhance deep bass) by lowering (raising) the subwoofer level.

Use the HTR 8's 'SURR','CENT' and 'SUB' keys for direct-access level adjustment of these channels over a range of ± 6 dB.

The surround back channels (if any) adjust in lockstep with the surround channels.

NOTE

Level settings adjusted 'On the Fly' are added or subtracted to the setup levels established at the T 777 level-calibration routine as invoked by the HTR 8 'Test' key. However, selecting any Preset will revert the channel levels to those stored in the preset.

ZONE SETUP

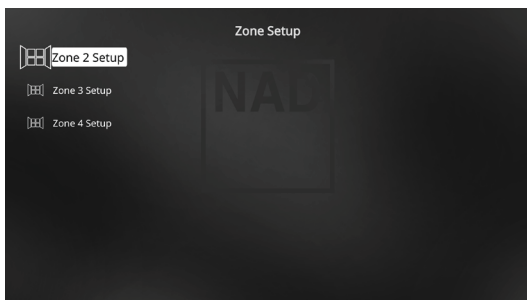

The Zone feature allows one to simultaneously experience in different zones of the house multiple sound sources from all enabled analog Sources as well as from Front Input and Media Player.

The T 777 has three configurable Zones – Zone 2, Zone 3 and Zone 4.

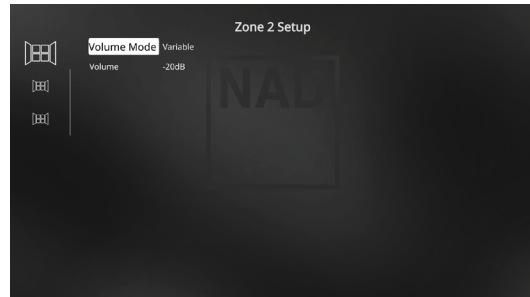

VOLUME

Zone 2 have Fixed and Variable volume control. When set to 'Variable' and while at the 'Zone Controls' menu OSD, the Zone 2 Volume level can be adjusted using the HTR 8's [\blacktriangle / \blacktriangledown] or the corresponding front panel navigation buttons or directly via ZR 7's [VOL \wedge / \vee].

On the other hand, if Volume is set to 'Fixed', the Zone 2 Volume is set to a preset dB level and thereafter the Zone's volume can be varied via the volume control of the separate amplifier it is fed into.

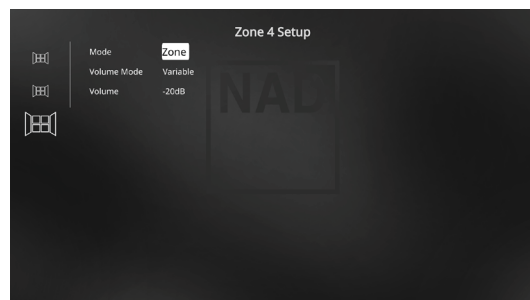
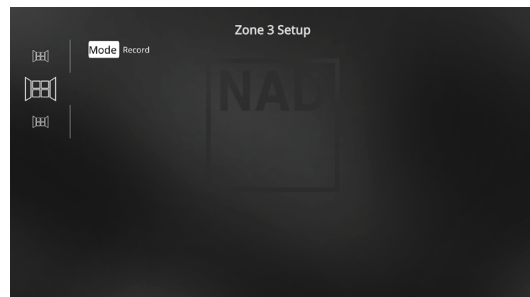

MODE

Zone 3 and Zone 4 can be configured into two modes - Record and Zone. If the selected mode is "Record", the audio of the assigned Source is directly sent out to the applicable Audio output (See Item 3 AUDIO 1-6/AUDIO 3-4 OUT). When Zone 3 or Zone 4 is set to "Record" mode, they will not be available at the "Zone Controls" section of the Main Menu window.

Zone 3 and Zone 4 "Volume" will function the same way as that of Zone 2 when "Mode" is set to "Zone".

See discussion also on 'Zone Controls' at the Main Menu.

NOTE

The ZR 7 remote control will only control Zone 2 applications.

OPERATION

USING THE T 777 – SETUP MENU

ENGLISH

AMPLIFIER SETUP

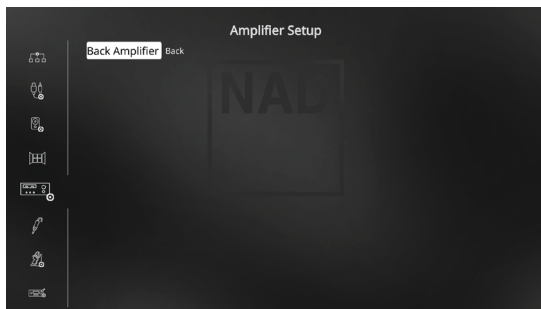

If the surround back speakers are not used in the main zone, their surround back amplifier channels could be assigned for Back, Front (Bi-Amp), Height 1, Height 2, Zone 2, Zone 3 and Zone 4.

The Surround Back amplifier is configurable through the following settings

- **Back:** Assign as surround back speakers.
- **Front (Bi-Amp):** Provide a bi-amp mode for the Main Front speakers (Left and Right) speakers thus reproducing the Front Left and Front Right amplifier channel outputs.
- **Zone 2:** Assign the surround back amplifier channels to supply Zone 2 speaker level outputs from the surround back speaker terminals.
- **Zone 3:** Assign the surround back amplifier channels to supply Zone 3 speaker level outputs from the surround back speaker terminals.
- **Zone 4:** Assign the surround back amplifier channels to supply Zone 4 speaker level outputs from the surround back speaker terminals.
- **Height 1/Height 2:** Assign as Height 1 or Height 2 speakers.

TRIGGER SETUP

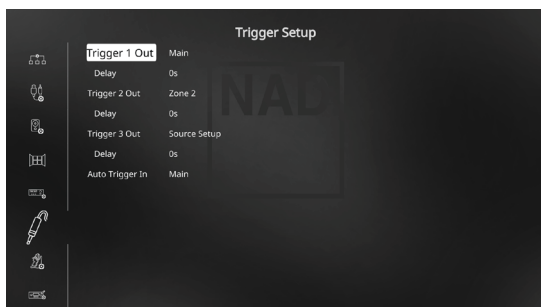

The T 777 features three configurable +12V DC Trigger Output that can be used to activate a component or system it is fed into. A Trigger Input is also available to turn on the applicable link it is associated to.

TRIGGER OUT

Triggers are low voltage signals used to turn on/off other compliant devices. The T 777's three +12V DC Trigger Outputs (Trigger 1 Out, Trigger 2 Out and Trigger 3 Out) are dependent upon the mode they are associated with. There are six choices where +12V DC output can be assigned and these are – Main, Zone 2, Zone 3, Zone 4, Zone 2+3+4 and Source Setup.

Main : +12V DC is available at the assigned Trigger Out when the T 777 is at powered state.

Zone 2, Zone 3, Zone 4, Zone 2, 3 and 4 : When the applicable Zone is at powered state, +12V DC is available at the assigned Trigger Out.

Source Setup : If Trigger Output is linked to 'Source Setup', +12V DC is available at Trigger Out whenever the particularly assigned Source is selected. Please see also separate discussion about 'Trigger Out' under the Source Setup section.

DELAY

The availability of +12V DC at Trigger Out can be regulated. If it is desired that +12V DC is available without delay the moment Trigger Out is linked to its assigned setting, set Delay to 0s. Otherwise, one can select through a delay time of 1s to 15s.

AUTO TRIGGER IN

Auto Trigger IN allows external system controllers to toggle the associated section of the T 777 from 'Standby' to 'On' and vice versa.

Main : From standby mode, the T 777 is powered ON when +12V DC is applied at Trigger IN.

Zone 2, Zone 3, Zone 4 : Applicable Zone is turned ON whenever +12V DC is present at Trigger IN.

All : Main, Zone 2, Zone 3 and Zone 4 as described above will all be activated given a +12V DC input at Trigger IN.

See also 'Item 7. +12V TRIGGER OUT, +12V TRIGGER IN of REAR PANEL discussion.

LISTENING MODE SETUP

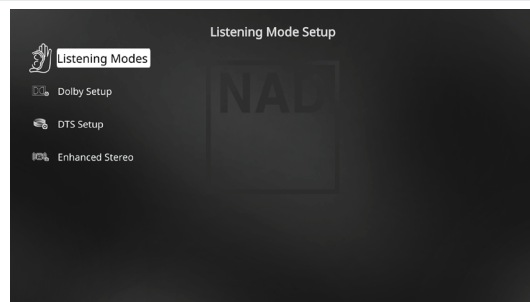

The T 777 has various listening mode options and is mostly configurable. These are provided to reproduce a variety of sound effects depending upon the content of the source to be played.

LISTENING MODES

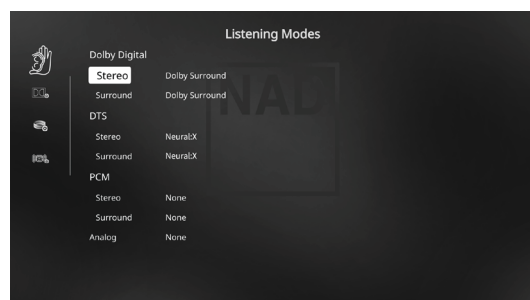

The audio format as detected by the selected Source can be automatically configured and processed through the following options:

DOLBY DIGITAL

Dolby Digital is the multi-channel digital signal format developed in the Dolby laboratories. Discs bearing the Dolby Digital (double-D symbol) logo were recorded with up to 5.1 channels of digital signals, reproducing a much better sound quality, with dynamic and spatial sound sensations that are much better than in the previous Dolby Surround.

A Dolby Digital audio input can be configured relative to its format as follows

Stereo: If the detected audio is of Dolby stereo format, you can default to either Dolby Surround or None.

Surround: If the detected audio is of Dolby Surround format, you can default to one of the following settings –Dolby Surround, Stereo Downmix or None.

None: If “None” is selected, the Dolby Digital signal will be defaulted to its native format. With this setting, “Direct” becomes available as a Listening Mode option.

DTS

The Digital Theater System Digital Surround (simply called DTS) is a multi-channel digital signal format that can process higher data rates than with Dolby Digital. Although both Dolby Digital and DTS are 5.1 channel media formats, discs bearing the “DTS” symbol are thought to provide better sound quality due to the lower audio compression required. It also offers a broader dynamic, producing magnificent sound quality.

A DTS audio input can be configured relative to its format as follows

Stereo: If the detected audio is of DTS format, you can default to one of the following settings – Neural:X or None.

Surround: If the detected audio is of DTS Surround format, you can default to one of the following settings – Neural:X, Stereo Downmix or None.

None: If “None” is selected, the DTS signal will be defaulted to its native format. With this setting, “Direct” becomes available as a Listening Mode option.

PCM

PCM (Pulse Code Modulation) is the digital representation of a standard audio signal converted with little or no compression. If “None” is selected, the audio signal will be defaulted to its native format.

Stereo: The detected stereo audio format will be configured into one of the following options – Neural:X, Dolby Surround, EARS, Enhanced Stereo or None.

Surround: The detected surround audio format will be configured into one of the following options –Neural:X, Dolby Surround, Stereo Downmix or None.

ANALOG

If the audio input is an analog signal, the following are the surround modes the input can be defaulted – Neural:X, Dolby Surround, EARS, Enhanced Stereo, Analog Bypass or None.

NOTE

Applicable Listening Modes can also be directly selected by repeatedly pressing front panel LISTENING MODE button.

LISTENING MODES

The T 777 offers distinct listening modes, tailored for different types of recording or program material. With a two-channel (Stereo) source, the following listening modes can be selected.

STEREO

Output is directed to the front left/right channels. Low frequencies are directed to the subwoofer if one is present in the Speaker settings. Select “Stereo” when you wish to listen to a stereo (or monaural) production, such as a music CD, without surround enhancement. Stereo recordings whether in PCM/digital or analog form and whether surround-encoded or not encoded, are reproduced as recorded. Multi-channel digital recordings (Dolby Digital and DTS) are reproduced in “Stereo Downmix” mode via the front left/right channels only as Lt/Rt (left/right-total) signals.

DIRECT

The analog or digital sources are automatically played in their native formats. All the source’s audio channels are reproduced directly. This mode recreates the original sound most faithfully thereby producing outstandingly high quality audio. Note that the source must be at playback mode for “Direct” to become available as a listening mode option. In order to automatically playback your source in their native format, implement the following settings.

- 1 Go to “Listening Mode Setup” under “Setup Menu”. At the “Listening Modes” menu, set all Dolby, DTS, PCM and Analog settings to “None”. With this setup, your source will be played back directly at its native format.
- 2 Next, go to “A/V Presets” under “Setup Menu”. At “A/V Presets” menu, set “Listening Mode Setup” item to “Yes” and then save this setting among other options, say to “Preset 1”, by selecting “Save Current Setup to Preset”.
- 3 Now, you can associate “Preset 1” to any of the “Source” settings. For example, at Source 1 setting under “Source Setup”, scroll down to “A/V Preset” item and set it to “Preset 1”. Thus whenever Source 1 is selected, the associated source will always be directly played back at its native audio format.

OPERATION

USING THE T 777 – SETUP MENU

EARS

Two-channel recordings, whether stereo or surround-encoded, are reproduced with proprietary NAD surround processing with signal output to the front left/right, center and discrete left/right surround channels, plus subwoofer (assuming these are present in the current "Speaker Configuration"). EARS does not employ the surround back speakers (if any).

EARS extracts the natural ambience present in nearly all well-produced stereo recordings. It does not synthesize any ambience or other sonic elements and thus remains truer to the sound of the original musical performance than most other music-surround options.

Select EARS for listening to stereo music recordings and broadcasts. EARS produces a subtle but highly natural and believable ambience from nearly all "natural-acoustic" stereo recordings. Typically, these include classical, jazz, and folk genres as well as numerous examples from others. Its virtues include realistic, stable "front-stage" sonic imaging and spacious but unexaggerated ambient "virtual acoustics" that remain faithful to the original recording.

ENHANCED STEREO

All recordings are reproduced in stereo via the maximum speaker complement configured in the current "Speaker Configuration". Enhanced stereo can be useful for maximum volume from all channels or for multi-speaker background music (cocktail party) listening. For this mode, Front, Center, Surround and Back speakers can be turned ON/OFF as desired.

ANALOG BYPASS (APPLICABLE ONLY WHEN THE SOURCE SELECTED IS 7.1 CHANNEL INPUT - DEFAULTED TO SOURCE 7)

All analog signals remain in the analog domain without analog-to-digital conversions. At Analog Bypass, the DSP circuitry is bypassed but full tone control functions remain. "Bass management" or Speaker settings are also not in effect as these are DSP functions.

DOLBY ATMOS

Dolby Atmos redefines your entertainment experience. Overhead dimension is added by creating a full audio atmosphere and realistically depicting objects moving overhead. Sound from a helicopter, a car screeching around a corner or a melodic bird call can be precisely placed and moved anywhere in your room, including overhead, to flow above and around you in three-dimensional space. Dolby Atmos also renders everything from dialogue to quiet scenes to whirlwind action with astonishing clarity, richness, detail and depth.

DTS:X

DTS:X places sound where it would occur naturally in space, creating the most lifelike, multi-dimensional audio experience ever. DTS:X technology adapts to the viewing environment, allowing for a flexible speaker configuration that best fits the viewing space. Through the use of object-based audio, DTS:X technology is able to scale immersive soundtrack presentations across a wide range of playback systems, from efficient to extravagant, while staying true to the content creator's vision.

Neural:X

Neural:X™ is the latest spatial remapping engine from DTS, enabling an immersive, multidimensional experience from legacy content. It is included inside of DTS:X to provide upmix of Neural:X-encoded and non-encoded (PCM) data. With DTS Neural:X, stereo, 5.1 or 7.1 content can be upmixed to take full advantage of all speakers in your surround sound system.

DOLBY SETUP

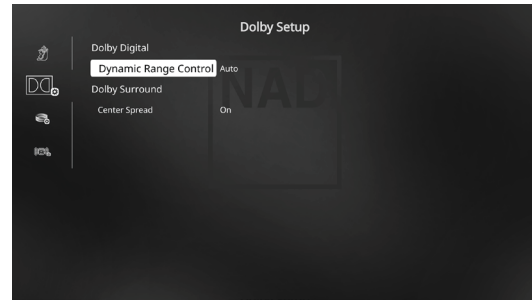

Dynamic Range Control: You can select the effective dynamic range (subjective range from soft to loud) for playback of Dolby Digital soundtracks. For fully cinematic effect, always select 100%, the default. Settings of 75%, 50%, and 25% progressively reduce dynamic range, making soft sounds comparatively louder while limiting the peak loudness of loud ones.

The 25% setting will yield the least dynamic range and is best for late-night sessions or other times when you wish to retain maximum dialog intelligibility while minimizing overall volume levels.

For Dolby TrueHD sources, set the Dynamic Range Control to "Auto".

Center Spread: Center image is spread into the Left and Right speakers. It is designed to complement musical content or to spread the dialogue more evenly across a wide screen display.

On: Center Spread function is enabled.

Off: Center Spread function is disabled.

DTS SETUP

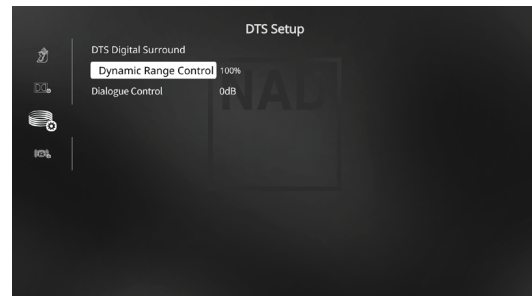

Dynamic range control and dialog content can be configured at DTS Setup menu.

Dynamic Range Control: This is the same configurable Dynamic Range Control feature as described above at Dolby Setup, the only difference being the soundtrack is now in DTS format.

Dialog Control: Dialog levels are adjusted. Dialog control is more than just adjusting center channel level as the center channel may also contain other sound elements that get raised or lowered along with the dialog.

NOTE

Dialog control applies only for playback of DTS:X content that supports DTS Dialogue Control feature.

ENHANCED STEREO

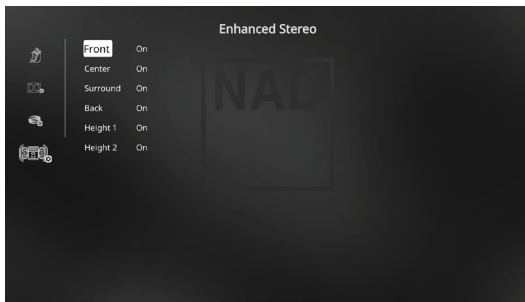

Please refer to the same description of 'ENHANCED STEREO' under the 'LISTENING MODES' segment of the 'OPERATION - USING THE T 777 - MAIN MENU'.

FRONT PANEL DISPLAY SETUP

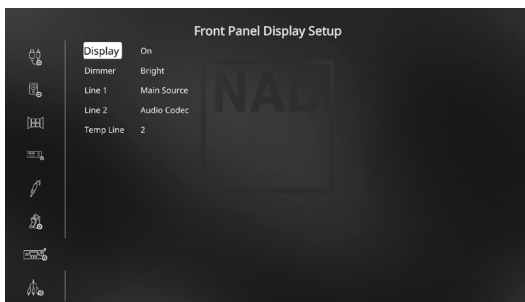

The Vacuum Fluorescent Display (VFD) and On-Screen Display (OSD) can be shown in various ways by navigating through the parameters at the "Front Panel Display Setup" menu.

NOTE

The configurations set forth at "Front Panel Display Setup" are carried over whenever it is enabled during A/V Presets setting. Please see also the section below about "A/V Presets".

Display : Select 'On' to display all applicable data or characters at the VFD. Nothing will be shown at VFD if 'Temp' is selected. At 'Temp' setting however, whenever any of the front panel controls or their corresponding keys in the remote control is activated, the appropriate VFD characters will be shown temporarily and then fade away. Note that if any of the Zones are at powered state, they will be continually shown at VFD even at 'Temp' setting.

Dimmer : If it is desired to reduce the brightness of the VFD, set Dimmer to 'Dim'. Otherwise, select 'Bright' to return to normal VFD brightness.

Line 1, Line 2 : The VFD shows two main lines of data or characters. Line 2 is the line of data or characters located at the lower bottom of the VFD while directly above it is Line 1. For both lines, one can select which display could be shown by choosing through the following

Main Source : Shows the active Source.

Volume : Current Volume level is shown.

Listening Mode : Selected Listening Mode is shown.

Audio Source Format : Shows the active Source's detected audio format.

Audio Codec : Displays the detected audio stream format like Analog, PCM Surround, Dolby TrueHD, DTS-HD Master Audio and other formats.

Video Mode : Show the video resolution of the active input source.

Details shown include the video resolution with frame rate. For a better understanding of these video details, consult with your NAD Audio Specialist or your distributor's technical department.

Zone 2-Zone 3-Zone 4 Source : The assigned Source for the applicable Zone is shown.

Off : Select 'Off' if it is desired not to show any data at the applicable Line.

Temp Line : Choose between Line 1 and Line 2 as the desired line where VFD will be temporarily shown if 'Temp' is selected at 'Display' option as described above.

OPERATION

USING THE T 777 – SETUP MENU

A/V PRESETS

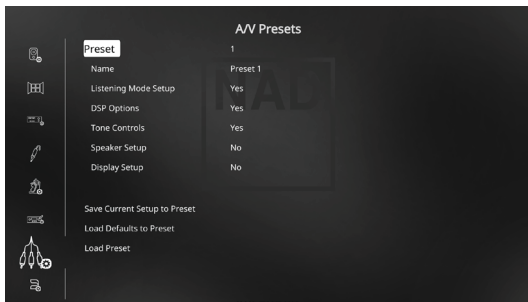

The T 777's simple but powerfully flexible system of "A/V Presets" allows you to customize virtually every aspect of your audio-video playback, and recall them with a single key-press. The parameters "DSP Options" and "Tone Controls" accessible via the "Main Menu" together with "Listening Mode Setup", "Speaker Setup" and "Front Panel Display Setup" configurable through "Setup Menu" are stored together as a single A/V Preset.

You might create one A/V Preset optimized for pop music and another for classical. One more A/V Preset can be set up to recall each family member's favorite setting or one for fully cinematic home-theater playback and yet another one for late-night movies, with each A/V Preset fine-tuned to a particular scenario or preference.

CREATING PRESETS

Creating an A/V Preset consists simply of storing a complete set of the parameters set forth in "DSP Options" and "Tone Controls" accessible via the "Main Menu" together with "Listening Mode Setup", "Speaker Setup" and "Front Panel Display Setup" configurable through "Setup Menu".

Scroll to "A/V Presets" using the [▲/▼] keys to save a collection of said parameter settings to a Preset. Select a Preset number and by pressing the [▲/▼] keys, you can selectively include in the particular A/V Preset any of the above-mentioned parameter settings by choosing "Yes". If you decide not to include in the particular A/V Preset a certain parameter setting, select "No".

Now in order to save the settings chosen for the particular A/V Preset number, scroll down to "Save Current Setup to Preset" and press the [D] key. If you chose to load instead the default settings, scroll down to "Load Defaults to Preset" and press the [D] key to restore the default settings.

In addition to the parameter settings, the A/V Preset label itself can be assigned a new name. This new Name will be shown in the VFD as well as on the OSD.

To rename the A/V Preset label, scroll to "Name" and press [D] to go the first character. Then, press [▲/▼] to pick and select through the alphanumeric selections. Press [◀/▶] to move to the next character or back to the previous character and at the same time save the changes done on the current character.

NOTE

The selected A/V Preset remains in force until you select a different A/V Preset.

SAMPLE PROCEDURE FOR SETTING UP A/V PRESETS

- 1 Setup first your preferred settings for the following options (access them through their respective menu page).

Listening Mode Setup: Listening Modes/Dolby Digital/Stereo/Dolby Surround

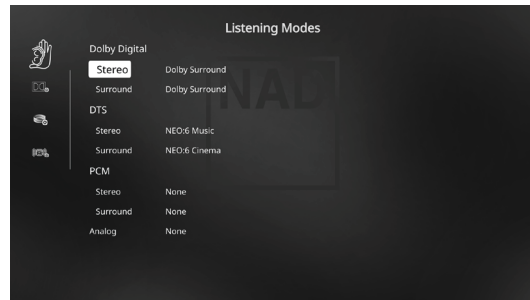

DSP Options: Lip Sync Delay/0ms

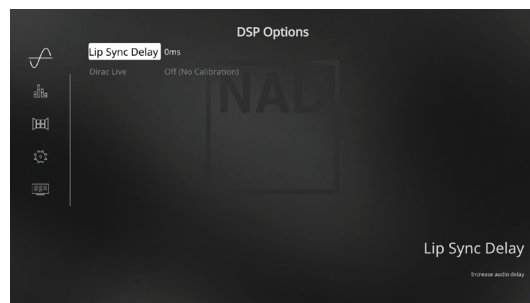

Tone Controls: Tone Defeat/Off

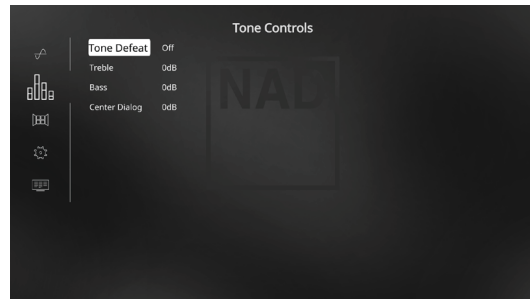

Front Panel Display Setup: Set "Line 2" to "Volume"

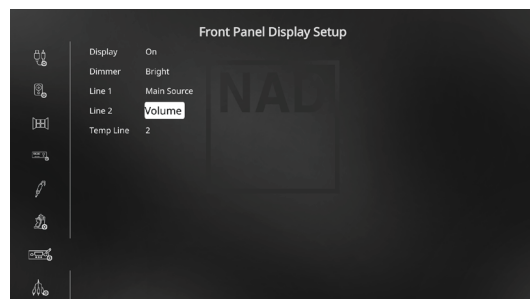

Speaker Setup: from the Speaker Setup menu, go to “Speaker Configuration” sub-menu and change “Height 1” and “Height 2” from “Off” to “On”.

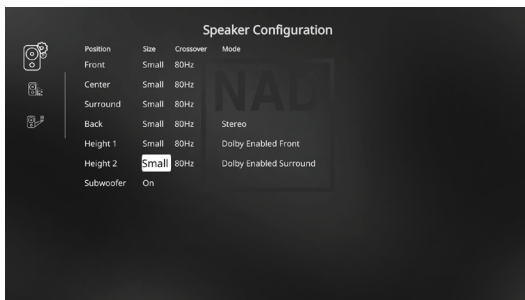
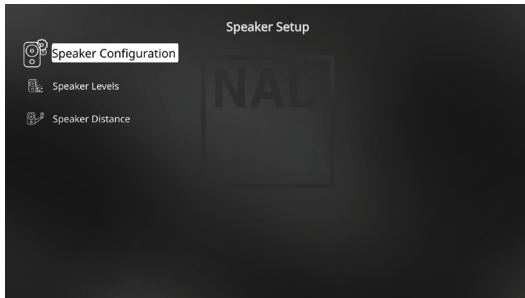

2 With the above settings, scroll to “A/V Presets” from the SETUP MENU page. Use [D] to access “A/V Presets” menu.

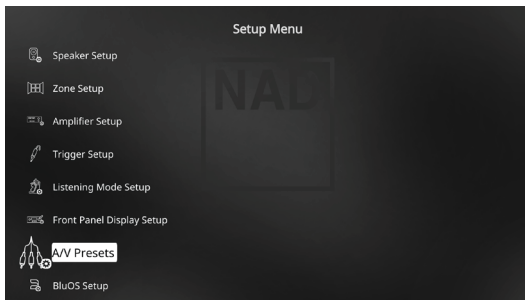

3 At “A/V Presets” page, set “Preset: 1” to the following conditions - use [▲/▼] to select “Yes” and press [ENTER] to confirm selection and move on to the next setting.

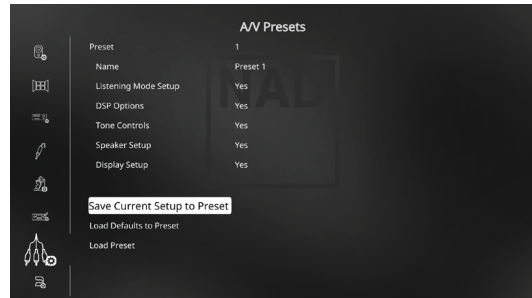

While at “Save Current Setup to Preset” menu line, use [D] to save the above settings to Preset 1. Below OSD will be shown, affirming that the above settings are now saved to “Preset 1”.

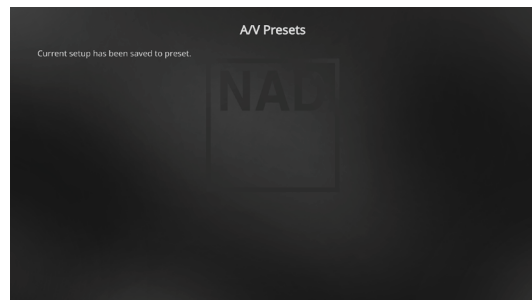

When you recall “Preset 1” using the remote control (for HTR 8, “A/V PSET” + “1”), the above preset values allocated at “Preset 1” (preset settings as shown in the OSD captures at Step 1) will be recalled and effected at the current source.

4 Now, repeat again Step 1 above but this time with the following settings

Listening Mode Setup: Listening Modes/Dolby Digital/Stereo/None

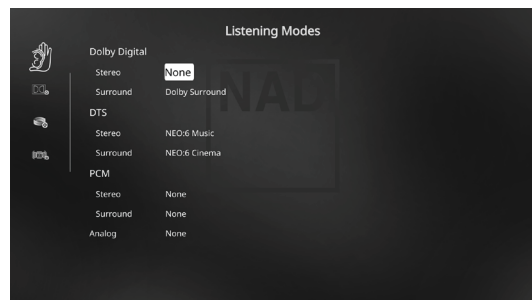

DSP Options: 5ms

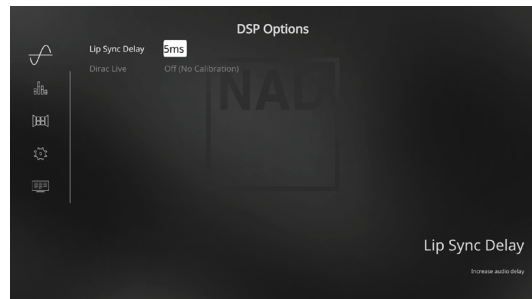

OPERATION

USING THE T 777 – SETUP MENU

ENGLISH

Tone Controls: Tone Defeat/On

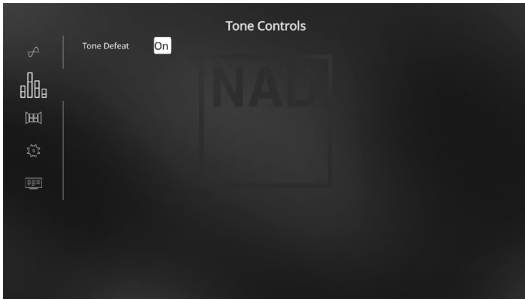

Front Panel Display Setup: Set "Line 2" to "Audio Source Format"

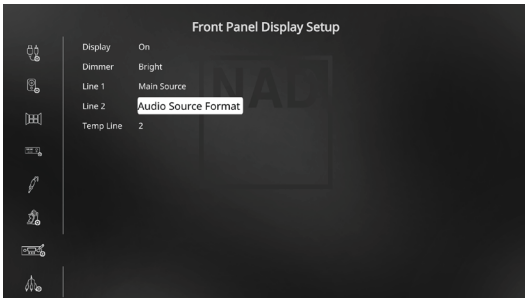

5 With the above settings, scroll to "A/V Presets" from the SETUP MENU page. Use [] to access "A/V Presets" menu.

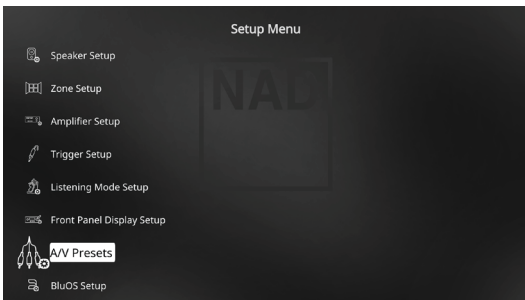

6 At "A/V Presets" page, set "Preset: 2" to the following conditions - use [] to select "Yes" or "No" and press [ENTER] to confirm selection and move to the next setting.

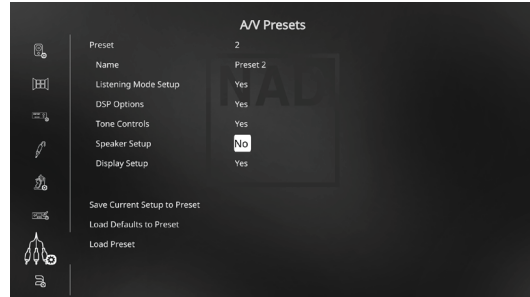

While at "Save Current Setup to Preset" menu line, use [] to save the settings above to "Preset 2". When you recall "Preset 2" using the remote control (for HTR 8, "A/V PSET" + "2"), the above preset values allocated at "Preset 2" (preset settings as shown in the OSD captures at Step 4) will be recalled and effected at the current source.

Note that "Speaker Setup" is set to "No". At this condition, there will be no "Speaker Setup" values that will be effected at "Preset 2". The "Speaker Setup" settings that will be applied at "Preset 2" will be the last or current "Speaker Setup" settings which in this sample are the same "Speaker Setup" settings shown above in Step 1.

7 You can setup up to 5 A/V Presets. These same A/V Presets can also be associated/defaulted to each Source in the "Source Setup" window as below.

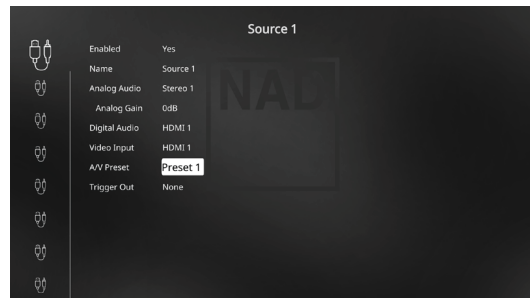

In the above example, "Preset 1" settings are allocated for Source 1. Whenever Source 1 is accessed, the "Preset 1" settings will be applied to Source 1. You can still manually override the assigned A/V Preset allocation in a specific Source with another Preset setting/number by way of pressing the appropriate remote control buttons.

RECALLING PRESETS

You may recall an A/V Preset number at any time using the HTR 8 remote control. Press the HTR 8's A/V PSET key and then the numeric key 1-5 corresponding to the desired A/V Preset number. The newly recalled A/V Preset will then manifest or replace the previous A/V Preset (if any).

BluOS SETUP

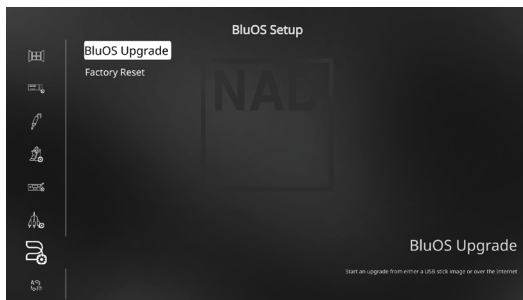

BluOS is a music management software developed by NAD's sister brand, Bluesound. BluOS adds BluOS network and internet music streaming with advanced music management to the T 777.

There are two BluOS Setup options – BluOS Upgrade and Factory Reset.

BLUOS UPGRADE

Select "Yes" to initiate BluOS upgrade mode. Ensure that the Dongle is installed and connected wirelessly. Follow the display screen prompt to complete the upgrade procedure.

FACTORY RESET

Initiate the restoring of the BluOS to its factory default settings. Select "Yes" to initiate factory reset or "No" to maintain current settings.

HOW TO SETUP WIRELESS CONNECTION

- 1 On your tablet or smartphone, look for the Wi-Fi network (hotspot) matching your BluOS' unique network ID, and join it. The network ID is listed as the product name (i.e. BluOS or T 777) immediately followed by the last four digits in the MAC (Machine Access Control address (example: BluOS-001A, T 777-001A).
- 2 Open a web browser on your tablet or smartphone, enter <http://10.1.2.3> and press "Go" or ENTER.
- 3 A Control Panel page should appear. Select "Configure WiFi" and you will be redirected to "Configure Wireless" page.
- 4 Select your home network or applicable wireless network name (SSID) from the "Configure Wireless" drop down menu
- 5 Enter your home network's Wireless Password (Passphrase, WEP/WAP key as applicable) in the field "Enter password or key (if protected)".

The Password (Passphrase, WEP/WAP key as applicable) is the same Password that was setup or generated during the configuration of your home router or gateway. An incorrect password entered in the "Configure wireless" menu screen will simply cause the unit to timeout and return to Hotspot Mode.

Trying multiple passwords will not damage the device in any way. If you are not sure what is your Password, login to your router and locate the Password in the applicable setup screen for Wireless Configuration section. Refer to your router's documentation for further information.

- 6 Select a "Player name" from the drop down list or use the on-screen keyboard to create a customized room name in the field "Custom name".
- 7 Press "Update" and wait until the "Congratulations! ..." page appears in the browser. This indicates successful connection to your home Wi-Fi network.
- 8 Reselect your home Wi-Fi network from your tablet or smartphone's main network settings.

Download the BluOS Controller App from the respective App stores of Apple iOS devices (iPad, iPhone and iPod), Android devices, Kindle Fire and Windows or Mac desktops.

Launch the BluOS Controller App and explore everything from your streaming music services, internet radio stations, networked music collections and favorites with quick and easy single-search discovery.

SELECT LANGUAGE

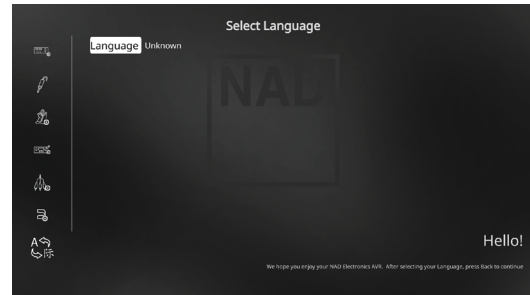

"Select Language" allows the selection of language the OSD is presented. There are two language choices – English and Chinese.

MASTER QUALITY AUTHENTICATED



Master Quality Authenticated (MQA) is a revolutionary end-to-end technology built into T 777 that captures and delivers master quality audio. T 777

includes a powerful decoder and audio renderer for the MQA system. This ensures that MQA-encoded audio files sound exactly like the source.

In the BluOS app, the MQA indicator displays green or blue to indicate that the unit is decoding and playing an MQA file. It displays green to indicate decoding and playback of a MQA file and denotes provenance to ensure that the sound is identical to that of the source material. It displays blue to indicate playback of MQA Studio file that has either been approved in the studio by the artist/ producer or has been verified by the copyright owner.

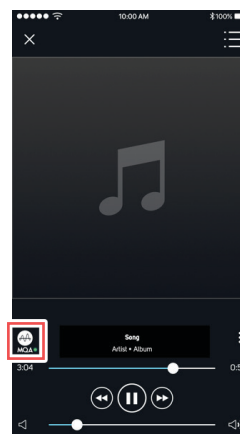

Green Indicator - Original MQA file

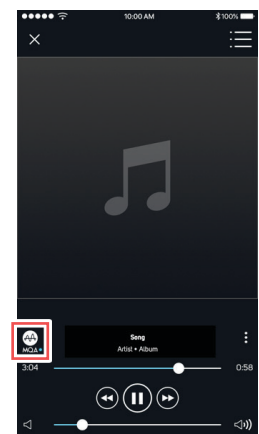

Blue Indicator - MQA Studio file

IMPORTANT

When listening to MQA audio files, set the following options for optimal performance

- Setup Menu → Listening Mode Setup → Listening Modes → PCM → Stereo/Surround → None
- Main Menu → Tone Controls → Tone Defeat → On

MQA® is a trademark of MQA Limited.

OPERATION

USING THE HTR 8 REMOTE CONTROL

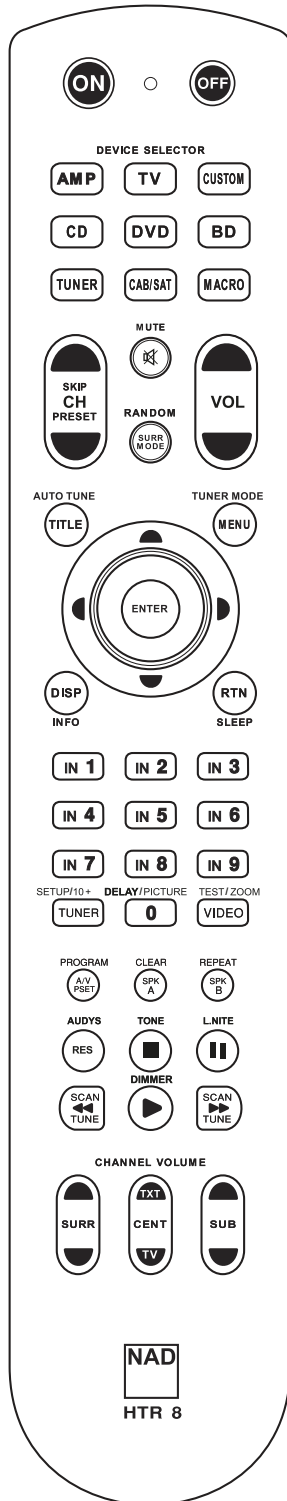

OVERVIEW OF THE HTR 8

- Controls up to 8 devices.
- Learns up to 360 commands.
- Records up to 52 macros with a maximum of 64 commands each.
- Configurable punch-through.
- Key illumination with programmable timeout.
- Upgradable.
- Contains pre-programmed library of NAD remote codes.

The NAD HTR 8 is ready to operate the T 777 right out of the box, but it is really eight remotes in one. Each of the 8 DEVICE SELECTOR keys at the top of the handset can call up a new “page” of remote control codes to be transmitted by the remaining keys. You may “teach” codes from any infrared-remote controlled component, regardless of brand, to any or all of these.

Obviously, the most logical system is that you teach the codes from your DVD player to the [DVD] DEVICE SELECTOR “page”, your television’s codes to the [TV] “page” and so on, but there is no required scheme: You may load any commands to any key on any page (see “LEARNING CODES FROM OTHER REMOTES” below).

The HTR 8 is already pre-programmed with a full complement of T 777 commands on its [AMP] DEVICE SELECTOR page, and as well as with library commands to operate most NAD-brand DVD, BD, CD or TUNER components on the corresponding DEVICE SELECTOR “pages”. These default commands are permanent: Even if you teach the HTR 8 new commands to take their place, the underlying library commands remain in place and can easily be recalled should you add an NAD component to your system later (see “DELETE MODE” below).

GETTING FAMILIAR WITH THE HTR 8

The HTR 8 is divided into two main sections. Eight DEVICE SELECTOR keys at the top—[AMP], [DVD], [TV] and so on - set the handset’s remaining keys to a “page” of commands to control a particular component. A DEVICE SELECTOR key determines only what component the HTR 8 will command; it does not perform any function on the component. All the remaining keys are function keys that can “learn” control codes from virtually any infrared remote controller, allowing you to teach the codes of your equipment, regardless of brand, to the HTR 8.

However, the HTR 8 is already pre-programmed to operate the T 777. All of the function keys on the [AMP] Device Selector “page” perform T 777 functions. The HTR 8 can also command many other NAD components from its [DVD], [CD], [BD] and [TUNER] pages.

It is important to note that certain HTR 8 keys perform different functions depending on the selected DEVICE SELECTOR “page”. The colour of the DEVICE SELECTOR key-labelling corresponds to the labelling of the function keys. Most centrally, the black [AMP] DEVICE SELECTOR “page” corresponds to the black keys: When the HTR 8’s [AMP] DEVICE SELECTOR page is active; these keys select the amplifier or receiver inputs. Similarly, the purple [DVD] DEVICE SELECTOR “page” corresponds to several purple labels and so on.

LEARNING CODES FROM OTHER REMOTES

Begin by positioning the HTR 8 “nose-to-nose” with the source remote so the two devices’ infrared windows are about 2 inches apart.

- Enter Learning Mode: On the HTR 8, simultaneously press-and-hold for 3 seconds both a DEVICE SELECTOR key and the [RES] key until the Learn LED of the HTR 8 turns steady green.
- Press the HTR 8’s function key you wish to teach a command; the Learn LED will turn amber.
- Press-and-hold the function key on the source remote: The HTR 8’s Learn LED will flicker amber for a second or two, then turn solid green. The command is learned.
- Press the HTR 8’s DEVICE SELECTOR key again to exit the learning mode.

If the Learn LED does not flicker amber you may need to vary the distance between the remotes. If the Learn LED turns red rather than green, that particular command of that source remote command could not be learned. In rare instances, there may be some IR format that is not compatible with the HTR 8.

Example: Learning "DVD Pause"

Position the HTR 8 and your DVD player's remote as described above.

- On the HTR 8, simultaneously press-and-hold [DVD] and [RES]; the Learn LED turns steady green.
- Press the HTR 8's Pause [III] key; the Learn LED turns amber.
- Press-and-hold the corresponding Pause key of your DVD player's remote control; the HTR 8's Learn LED flickers amber and then turns solid green. The command is learned.
- Press [DVD] again to exit the learning mode.

NOTES

- *The HTR 8 can learn up to 360 commands making use of all the DEVICE SELECTOR and function keys.*
- *The DEVICE SELECTOR keys can themselves be configured to learn a command.*
- *Press and hold a configured DEVICE SELECTOR for at least 2 seconds to execute a function assigned to the particular DEVICE SELECTOR key.*
- *Short press of a configured DEVICE SELECTOR will just switch the active device.*

CANCEL OPERATION

You can cancel configuring a key, by pressing the active DEVICE SELECTOR key before the learn process is complete; the Learn LED will turn red.

PUNCH THROUGH

The HTR 8's "punch-through" function allows you to retain a function key from one Device Select "page" to another, so that, for example, the AMP [SURR MODE] function might still control the T 777 when the DVD DEVICE SELECTOR page is active.

NOTE

The HTR 8's [VOL ▲/▼] keys are pre-programmed as "punched-through" for all Device Select pages: [VOL ▲/▼] will operate the T 777's master-volume regardless of the currently selected device. The [SURR] [CENTER] and [SUB] Channel Volume controls similarly are pre-programmed as punched-through.

To set a punch through, after entering the Learning Mode, and pressing the desired key to be punched through, simply press the device key twice of the device to punch through to. The status LED will turn green; press the DEVICE SELECTOR key again to exit Learning Mode.

Example: Punch-through AMP [SURR MODE] key to the DVD "page"

- On the HTR 8, simultaneously press-and-hold [DVD] and [RES]; the Learn LED turns steady green.
- Press [SURR MODE]; the Learn LED turns amber.
- Press [AMP] twice; the Learn LED turns green.
- Press [DVD] again to exit the learning mode.

COPY A COMMAND FROM ANOTHER KEY

You may copy a command from any HTR 8 key to any other. To copy a key function, after entering the Learning Mode, and pressing the desired key to be copied to, simply press the device key from which you wish to copy, having first pressed its DEVICE SELECTOR key if it resides on another "page." The status LED will turn green; press the DEVICE SELECTOR key again to exit Learning Mode.

Example: Copy the Pause command from the CD page to the AMP [II] button

- On the HTR 8, simultaneously press-and-hold [AMP] and [RES]; the Learn LED turns steady green.
- Press Pause [II]; the Learn LED turns amber.
- Press [CD]; press Pause [II]; the Learn LED turns green.
- Press [AMP] again to exit the learning mode.

NOTE

The copy and punch-through functions are similar. However, if you copy a command and then subsequently delete or overwrite the original (source-key) command, the copied-to key's command remains unchanged. If you punch-through to a command and then delete or overwrite the original key, the punched-through functions also change accordingly.

MACRO COMMANDS

A "macro" command is a series of two or more remote codes issued automatically from a single keypress. You might use a macro to automate a simple command sequence, such as, "Turn on the DVD player and then press PLAY". Or you might compose an elaborate macro to power up an entire system, select a source, choose a Listening Mode, and begin playback again, all from a single keypress. The HTR 8 can store one macro on each of its DEVICE SELECTOR and function keys.

NOTE

Macros are independent of the currently selected device.

RECORDING MACROS

To record a macro, simultaneously press-and-hold for 3 seconds both the [MACRO] key and the HTR 8 function key to which you wish to assign the macro, until the status LED turns green. The macro button will also light up.

Press the sequence of function keys to be recorded into the macro, being sure to first press the requisite DEVICE SELECTOR key for each function (you may switch devices while recording the macro as many times as necessary), allowing you to create macro containing commands from more than one DEVICE SELECTOR "page."

When you have finished entering the desired command sequence, press [MACRO] again to store the macro; the Learn LED and [MACRO] key illumination will turn off.

NOTE

Each macro can store a maximum of 64 command steps. If you exceed this number, the macro will be stored automatically after the 64th command is added.

OPERATION

USING THE HTR 8 REMOTE CONTROL

Example: Record a Macro to the [0] key to turn ON the T 777, turn ON the DVD Player, Select Input 1 (Source 1) and commence disc playback of connected Source 1 device (as in the DVD player)

- On the HTR 8, simultaneously press-and-hold [MACRO] and [0] (numeric zero); the Learn LED turns steady green.
- Press [AMP], press [ON]; press [DVD], press [ON]; press [AMP], press [1] (Input 1); press [DVD], press [▶] (Play) – the Learn LED blinks as each step is added.
- Press [MACRO] again to exit the macro-record mode.

To clear a macro, perform the above steps without entering any functions.

EXECUTING MACROS

To execute a macro, press and release [MACRO]; its key illumination lights for 5 seconds. While it remains lit, press an HTR 8 key to which a macro has previously been stored.

The corresponding macro will run; as each step executes, its “parent” DEVICE SELECTOR key flashes briefly; when execution is finished, the [MACRO] key illumination goes out. Pressing any other HTR 8 key while a macro is executing will abort the macro. Remember that you must hold the HTR 8 so that its infrared emitter can activate the target components.

NOTE

When a macro executes, a 1 second delay is automatically inserted between its commands. If you need more than a 1 second delay between particular commands—for example, to permit a component to power up completely—you can record “empty” steps into the macro by changing DEVICE SELECTOR “pages” without entering actual command functions.

KEY ILLUMINATION TIMEOUT

The HTR 8’s key-illumination can be set to remain lit for 0-9 seconds. The default value is 2 seconds. To set the illumination timeout, simultaneously press-and-hold for 3 seconds both the HTR 8’s [DISP] and the [0-9] key, with the digit corresponding to the desired timeout duration; the Learn LED will flash twice to confirm the new setting. When set to zero, the illumination will not turn on at all.

NOTES

- Key illumination is activated when one presses any HTR 8 key.
- If HTR 8 senses movement, key illumination is activated without having to press a key. If HTR 8 is shaken, key illumination is also activated.
- Key illumination is the biggest drain on the HTR 8’s batteries. A short key illumination timeout will extend battery life appreciably; turning it off altogether (set it to 0 seconds) will lengthen it still further.

CONFIGURING KEY ILLUMINATION

Keys to Press (for 3 seconds)	Mode
DISP + Digit Key (0-9)	Set key illumination timeout to number of seconds corresponding to digit key. Zero turns off the key illumination entirely.
DISP + OFF	Disable light sensor. Key illumination will turn on with any key press.
DISP + ON	Enable light sensor.
DISP + ENTER	Set the light sensor threshold to the current light level.
DISP + RTN	Restore all key illumination settings to the defaults.

FACTORY RESET

The HTR 8 can be reset to its factory state, deleting all learned commands, copied and punched-through keys, macros, and other setup information; reverting all keys to their pre-programmed library commands.

To perform a factory reset simultaneously press-and-hold for 10 seconds the HTR 8’s [ON] and [RTN] keys; the Learn LED will start to flash green. Release [ON] and [RTN] before the second flash is complete; the Learn LED will turn red, indicating the remote has been reset.

NOTE

You must release [ON] and [RTN] before the second flash goes out, otherwise the unit will not reset; should this occur, repeat the full procedure.

DELETE MODE

The HTR 8 can store learned, copied, and “default library” commands on any single key. The default library commands are the pre-programmed NAD codes, such as the native T 777 commands on the [AMP] “page”.

You can delete commands by layers back “down” to the default library command on any key, removing learned commands, punched-through functions, and copied keys.

NOTE

The default library commands cannot be deleted, so you need not worry that using Delete Mode might cause irreparable changes.

To enter Delete Mode, simultaneously press-and-hold for 3 seconds both the desired key’s DEVICE SELECTOR key and the [RTN] key, until the Learn LED turns green. Press the function key whose command you wish to delete; the Learn LED flashes; the number of times indicates which type of function has become active - see the table below. Press the active DEVICE SELECTOR key again to exit Delete Mode.

NOTE

You may delete multiple function-key commands on the same DEVICE SELECTOR “page”, but to delete from more than one DEVICE SELECTOR page you must exit Delete Mode and then re-enter it on the required page.

Flashes	Command Type
1	Default Library Command
2	Copied Library Command
3	Learned Command

LOADING CODE-LIBRARIES

The HTR 8 can store a different library of default NAD codes for each of its DEVICE SELECTOR “pages”. If the original default library does not control your NAD CD player, BD player, DVD player or other component, follow the procedure below to change the code-library.

Begin by ensuring that the component you wish the HTR 8 to control is plugged in and powered-up (“ON”, not merely in standby). To enter the HTR 8’s Library Mode, simultaneously press-and-hold for 3 seconds both the desired DEVICE SELECTOR key and the [A/V PSET] key, until the Learn LED turns green.

While keeping the HTR 8 pointed toward the component, enter the first appropriate three-digit code-library number from the table below and then press [OFF]. If the component turns off, press [ENTER] to accept that code-library number and exit the Library Mode. If the component does not turn off, enter the next three-digit code-library number from the table.

When you enter the correct number the component will turn off; press [ENTER] to accept that code library number and exit the Library Mode.

LIBRARY CODE	NAD PRODUCT DESCRIPTION	LIBRARY CODE	NAD PRODUCT DESCRIPTION
100	Receiver/Processor (Discrete ON/OFF)	300	Tuner
101	Receiver/Processor (Toggle ON/OFF)	301	L75, L76 Tuner
102	S170	302	L70 Tuner
103	L75	303	L53 Tuner
104	Second Zone Commands (Zone 2)	304	L73 Tuner
3112	Zone 3	305	C425
4112	Zone 4	306	C445
105	L70	307	Txx5 Series Tuner
106	L76	400	Tape Deck B
107	118	401	TAPE Deck A
108	L53	500	TV 280
109	L73	501	MR13
110	Stereo Receiver / Amplifier	502	MR20
111	Stereo Second Zone	503	PMR45
112	Txx5 Series	600	T535, T562, T585, M55
200	CD Player	601	T550, L55
201	CD Player (old)	602	T512, T531, T532, T571, T572
202	5170, 5240, 5340	603	L70, L73 DVD
203	5325	604	L56
204	5060	605	T513, T514, T515, T517, T524, T533, T534
205	M5	606	L53 DVD

SEARCH MODE

If none of the codes from the table, when entered, turns on the component, and if you are quite sure you have followed the above procedure completely and carefully, you may want to try the “search” method as follows:

Enter Library Mode by simultaneously pressing-and-holding for 3 seconds both the desired DEVICE SELECTOR key and the [A/V PSET] key, until the Learn LED turns green. Now press-and-hold the HTR 8’s [▲] or [▼] key; the remote will step through all the available codes at a rate of approximately 1 per second.

When the component turns off, immediately release the cursor key; press [ENTER] to accept that code-library and exit the Library Mode. Try a few commands; should you prove to have stepped past the needed code-library, re-enter the Library Mode and use the cursor key to step back to it.

NOTE

It is possible that search mode will find code-libraries that operate, at least partially, some other brand (non-NAD) components. You may certainly exploit such capabilities as you find them. However, since we can only ensure the completeness or accuracy of NAD code-libraries, we cannot support the HTR 8’s operation with other-brand components.

CHECKING CODE-LIBRARY NUMBER

You can check the current code-library on any DEVICE SELECTOR key as follows. Enter Library Mode by simultaneously pressing-and-holding for 3 seconds both the desired component’s DEVICE SELECTOR key and the [A/V PSET] key, until the Learn LED turns green. Press the [DISP] key; the HTR 8 indicates the current code-library by flashing its [CUSTOM], [BD], and [MACRO] keys.

For example, to indicate code-library #501, the HTR 8 will flash [CUSTOM] 5 times, pause, and then flash [MACRO] once. You might wish to make a note of your components’ code-library numbers.

SUMMARY OF THE HTR 8 MODES

Mode	Keys To Press (for 3 seconds)
Learn/Copy/Punch Through	Device Key + RES Key
Delete Mode	Device Key + RTN Key
Macro Record	MACRO Key + Function Key
Library Mode	Device Key + A/V PSET Key
Back Light Timeout	DISP Key + Digit Key
Factory Reset	See “Factory Reset” above

OPERATION

USING THE HTR 8 REMOTE CONTROL

USB INTERFACE

The HTR 8 allows one to upload and download the configuration through a Windows® PC and NAD's Proprietary HTR 8 programming software. Use a USB A male to mini USB B male 5-pin cable (not supplied) between your Windows® PC and the HTR 8. See illustration below on how to connect a USB A male to mini USB B male 5-pin cable to the HTR 8.

NOTE

Please log onto www.nadelectronics.com/HTR8 for the latest HTR 8 interface control software. Your custom installer or dealer can assist you in the proper setup and configuration of the mini USB interface and software.

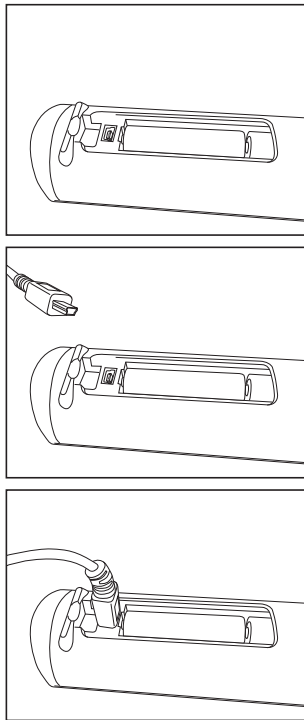

SLEEP MODE

The Sleep Mode timer will switch the T 777 to Standby mode automatically after a preset number of minutes. Pressing the HTR 8's SLEEP button once will display the setting of the sleep time increment. Pressing the HTR 8's SLEEP button a second time within a 3-second period will change the sleep time increment in 15-minute intervals, after which time the T 777 will automatically switch into Standby mode.

To adjust the sleep delay, press the HTR 8's SLEEP button twice; first to display the sleep time increment, and a second time to change the sleep time increment. The sleep time increment and a "SLEEP" icon will continuously display on the T 777's front panel Vacuum Fluorescent Display (VFD). Each consecutive press increases the sleep time in 15-minute increments from 15 to 90 minutes. To cancel the sleep mode, continue pressing the HTR 8's SLEEP button until "Sleep Off" displays on the VFD. Switching the T 777 to standby from either the HTR 8's OFF or the T 777's STANDBY button will also cancel the sleep mode.

USING THE ZR 7 REMOTE CONTROL

The ZR 7 is a discrete compact remote for controlling the Zone 2 feature of the T 777. Irrespective of the main room/zone settings, the ZR 7 allows full separate control of the Zone 2 source selection among other applicable features.



- 1 ON/OFF:** Switch ON/OFF the Zone feature.
- 2 SOURCE [^/∨]:** Select the active input of the NAD T 777 that will be sent out to the corresponding rear panel ZONE 2 output port.
- 3 MUTE:** Temporarily switch OFF or restore the Zone Volume level.
- 4 VOLUME [^/∨]:** Increase or decrease the loudness level of selected Zone source. This is possible only if the VOLUME setting of ZONE 2 CONTROLS is set to VARIABLE.
- 5 PRESET [</>]:** Step up or down between stored radio presets. This control button is possible if the selected Zone is "TUNER" and the active tuner section has stored presets. This control button is not applicable to T 777.
- The following CD Player Zone buttons can control a compatible CD Player. The CD Player has to be powered ON and disc loaded.
 - SKIP [►►]:** Go to the next track/file.
 - SKIP [◀◀]:** Go to the beginning of a track/file or previous track/file.
 - [►]:** Start playback.

NOTE

The ZR 7 remote control will only control Zone 2 applications. Zone 3 and Zone 4 could be configured and managed at the appropriate Zone OSD menu using the front panel navigations keys as well as the corresponding keys on the HTR 8 remote control. The HTR 8's 'CUSTOM' device is also defaulted to Zone 2 remote control codes.

The T 777 has the capability to operate via Alternate IR channel. This is practically useful if you have two NAD products that can be operated by similar remote control commands. With alternate IR Channel, two different NAD products can be controlled independently in the same zone by setting each one to a different IR channel.

IR CHANNEL ASSIGNMENT

The T 777 and the HTR 8 remote control must be set to the same channel.

To change the Main Zone IR Channel on the T 777

- Press and hold [< SOURCE] and then toggle STANDBY button to select desired IR Channel – the VFD will show “IR Channel 1” or “IR Channel 0”. The default IR Channel is “IR Channel 0”.

To change the IR Channel on the HTR 8 remote control

- Include a channel number before the library code. For HTR 8, library code “100” is the default library table for “AMP” device. To select this “AMP” library table for “IR Channel 0”, retain the library code “100”.
- If you want to load the “AMP” library table on “IR Channel 1”, prefix the library code with “1” to indicate association with “IR Channel 1”. Load then the “AMP” library table using the code “1100”.

SAMPLE SETUP OF TWO NAD PRODUCTS ON THE SAME ZONE

NAD T 777 and NAD C 368 are both defaulted to IR Channel 0. If [OFF] button is pressed on the HTR 8 remote control (or SR 9 remote control for the C 368), both products will go to standby mode. Press [ON] and both products will power up from standby mode.

To prevent both products from simultaneously going in and out of standby mode along with other common commands, set each one to a different IR channel. In this setup, we will keep C 368 and SR 9 remote control defaulted to “IR Channel 0”. As for T 777, we will assign it to “IR Channel 1”; the same applies to HTR 8.

Set T 777 and HTR 8 to “IR Channel 1” via the following procedure.

T 777

- Press and hold [< SOURCE] and then toggle STANDBY button to select “IR Channel 1”.

HTR 8

Begin by ensuring that the T 777 is powered-up (“on”, not merely in standby).

- To enter HTR 8’s library mode, press and hold both the [AMP] device and [AV PSET] until the LEARN LED turns green.
- While keeping the HTR 8 pointed towards the T 777, enter the library code “1100”. Press [OFF]. If the T 777 goes to standby mode, press [ENTER] to accept the library code number and exit library mode.

With both T 777 and HTR 8 set to “IR Channel 1”, the C 368 can now be remotely controlled independent of the T 777.

NOTE

Performing a Factory Reset for T 777 or HTR 8 will result to a return to the factory default “IR Channel 0” setting.

CONDITION	POSSIBLE CAUSES	POSSIBLE SOLUTIONS
No sound from all channels.	• AC power unplugged.	• Check AC cable connection and outlet.
	• Power not switched on.	
	• Outlet has no power.	• Toggle [MUTE] button to deactivate Mute function.
	• Mute function is activated.	
No sound from some channels.	• Faulty/missing cables.	• Check cables.
	• "Speaker Configuration" channel (s) set to "OFF".	• Check "Speaker Configuration" menu.
No sound from surround channels.	• No surround listening mode is engaged.	• Select appropriate listening mode.
	• Surround channels set to "OFF" on "Speaker Configuration" menu.	• Correct "Speaker Configuration" or "Speaker Levels" settings.
	• Surround channels level set too low on "Speaker Levels" menu.	
No sound from Subwoofer.	• Subwoofer is off, not powered or improperly connected.	• Power up subwoofer, check subwoofer's AC outlet or check connections.
	• Subwoofer set to "OFF" on "Speaker Configuration" menu.	• Correct "Speaker Configuration" or "Speaker Levels" settings.
	• Subwoofer level set too low on "Speaker Levels" menu.	
No sound from Center channel.	• Source is a 2/0 (etc.) Dolby Digital or DTS recording without center channel.	• Play a known 5.1-channel recording or select Surround mode.
	• Center set to "OFF" on "Speaker Configuration" menu.	• Correct "Speaker Configuration" or "Speaker Levels" settings.
	• Center level set too low on "Speaker Levels" menu.	
No Dolby Digital/DTS.	• Source's digital output is not connected to a T 777 digital input.	• Check connections.
	• Source component not configured for multichannel digital output.	• Check source component setup.
T 777 does not respond to remote control commands.	• Batteries are flat or incorrectly inserted.	• Check batteries.
	• Infrared receiver (IR) window of T 777 or IR transmitter of the remote control is obstructed.	• Check IR windows and ensure clear line-of-sight from remote to T 777.
	• T 777 front panel is in very bright sunlight or ambient light.	• Call your local DAB broadcast providers for Reduce sunlight/room lighting.

RESET T 777 TO FACTORY DEFAULT SETTINGS

Using front panel buttons only, press and hold [◀ SOURCE], then press and release [FRONT INPUT/MP] - "Factory Reset..complete." is shown in the front panel display.

AMPLIFIER SECTION

Power output, Stereo Mode	120W (20.8dBW) (8Ω within rated distortion)
IHF dynamic power; 8 Ω	160W (22.0BW)
IHF dynamic power; 4 Ω	260W (24.1dBW)
Power output, Surround Mode	7 x 80W (19.0dBW)
Total harmonic distortion at rated power	<0.08%
IM distortion at rated power	<0.08%
Damping factor, 8 Ω	>60
Input sensitivity and impedance	1.15V (ref. 8Ω, VOL at 0 dB)
Frequency response	±0.8dB (ref. 1 kHz, 20 Hz-20 kHz)
Signal/noise ratio	>92dB (ref. rated power at 8Ω, A-WTD)
Signal/noise ratio	>82dB (ref. 1W at 8Ω, A-WTD)

PREAMPLIFIER SECTION

Frequency response	±0.5 dB (ref. 20 Hz – 20 kHz)
Signal-to-noise ratio	>88 dB (ref. 2V, A-WTD)
Total harmonic distortion	<0.01%
Input sensitivity	330 mV (ref. 2V)
Maximum output level	>4V

POWER CONSUMPTION

Standby power	<0.5W
Idle Power	>70W (120V version only) >63W (230V version only)

DIMENSION AND WEIGHT

Unit Dimensions (W x H x D)	435 x 172 x 425 mm (Gross)* 17 ¹ / ₈ x 6 ¹³ / ₁₆ x 16 ³ / ₄ inches
Net Weight	20.5 kg (45.2 lbs)
Shipping Weight	24.2 kg (53.4 lbs)

* Gross dimension includes feet, volume knob and extended rear panel terminals.

Specifications are subject to change without notice. For updated documentation and features, please log onto www.NADelectronics.com for the latest information about T 777.

NAD SHALL NOT BE HELD LIABLE FOR ANY TECHNICAL OR USER INTERFACE DISCREPANCIES IN THIS MANUAL. THE T 777 OWNER'S MANUAL MAY BE SUBJECT TO CHANGE WITHOUT PRIOR NOTICE. CHECK OUT THE NAD WEBSITE FOR THE LATEST VERSION OF THE T 777 OWNER'S MANUAL.

For DTS patents, see <http://patents.dts.com>. Manufactured under license from DTS Licensing Limited. DTS, the Symbol, & DTS and the Symbol together, DTS:X, and the DTS:X logo are registered trademarks and/or trademarks of DTS, Inc. in the United States and/or other countries. © DTS, Inc. All Rights Reserved.

Manufactured under license from Dolby Laboratories. Dolby, Dolby Atmos, and the double-D symbol are trademarks of Dolby Laboratories.

HDMI, the HDMI logo and High-Definition Multimedia Interface are trademarks or registered trademarks of HDMI Licensing LLC.



www.NADelectronics.com

**©2019 NAD ELECTRONICS INTERNATIONAL
A DIVISION OF LENBROOK INDUSTRIES LIMITED**

All rights reserved. NAD and the NAD logo are trademarks of NAD Electronics International, a division of Lenbrook Industries Limited.
No part of this publication may be reproduced, stored or transmitted in any form without the written permission of NAD Electronics International.
While every effort has been made to ensure the contents are accurate at the time of publication, features and specifications may be subject to change without prior notice.

T777V3_ENG_OM_V14 - FEB 2019