



L 73

DVD Receiver

ENGLISH



Owner's Manual

WARNING

TO REDUCE THE RISK OF FIRE OR ELECTRIC SHOCK, DO NOT EXPOSE THIS PRODUCT TO RAIN OR MOISTURE.

CAUTION

TO PREVENT ELECTRIC SHOCK, MATCH WIDE BLADE OF PLUG TO WIDE SLOT, FULLY INSERT.

CAUTION

This Digital Video Disc Player employs a Laser System. To ensure proper use of this product, please read this owner's manual carefully and retain for future reference. Should the unit require maintenance, contact an authorized service location. (See service procedure). Use of controls, adjustments or the performance of procedures other than those specified may result in exposure to laser radiation. To prevent direct exposure to laser beam, do not try to open the enclosure. Visible laser radiation when the enclosure is opened.

DO NOT STARE INTO BEAM.

FCC NOTICE

This equipment has been tested and found to comply with the limits for a Class B digital device, pursuant to part 15 of the FCC Rules. These limits are designed to provide reasonable protection against harmful interference in a residential installation.

This equipment generates, uses and can radiate radio frequency energy and if not installed and used in accordance with the instructions, may cause harmful interference to radio communications.

However, there is no guarantee that interference will not occur in a particular installation. If this equipment does cause harmful interference to radio or television reception, which can be determined by turning the equipment off and on, the user is encouraged to try to correct the interference by one or more of the following measures:

- Reorient or relocate the receiving antenna.
- Increase the separation between the equipment and receiver.
- Connect the equipment into an outlet on a circuit different from that to which the receiver is connected.
- Consult the dealer or an experienced radio/TV technician for help.

EXAMPLE OF ANTENNA GROUNDING AS PER NATIONAL ELECTRICAL CODE INSTRUCTIONS CONTAINED IN ARTICLE 810 - RADIO AND TELEVISION EQUIPMENT.

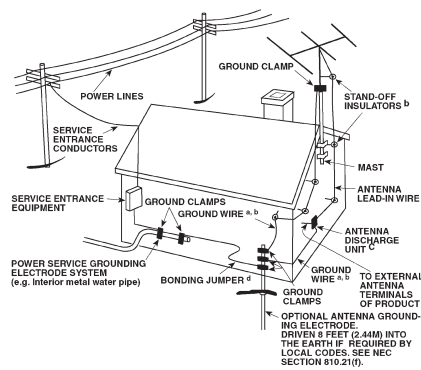

NOTE TO CATV SYSTEM INSTALLER: This reminder is provided to call the CATV system installer's attention to Article 820-40 of the National Electrical Code that provides guidelines for proper grounding and, in particular, specifies that the ground cable ground shall be connected to the grounding system of the building, as close to the point of cable entry as practical.

FCC WARNING

Changes or modifications not expressly approved by the party responsible for compliance could void the user's authority to operate the equipment.

INDUSTRY CANADA REQUIREMENT

This Class B digital apparatus meets all requirements of the Canadian Interference-Causing Equipment Regulations.

WARNING

TO PREVENT FIRE OR SHOCK HAZARD, DO NOT EXPOSE THIS APPLIANCE TO RAIN OR MOISTURE.



THE LIGHTNING FLASH WITH ARROWHEAD SYMBOL, WITHIN AN EQUILATERAL TRIANGLE, IS INTENDED TO ALERT THE USER TO THE PRESENCE OF UNINSULATED "DANGEROUS VOLTAGE" WITHIN THE PRODUCT'S ENCLOSURE THAT MAY BE OF SUFFICIENT MAGNITUDE TO CONSTITUTE A RISK OF ELECTRIC SHOCK TO PERSONS.



THE EXCLAMATION POINT WITHIN AN EQUILATERAL TRIANGLE IS INTENDED TO ALERT THE USER TO THE PRESENCE OF IMPORTANT OPERATING AND MAINTENANCE (SERVICING) INSTRUCTIONS IN THE LITERATURE ACCOMPANYING THE APPLIANCE

The equipment draws its nominal non-operational power from the AC outlet with its POWER switch in the STANDBY position.

CAUTION

Changes or modifications to this equipment not expressly approved by NAD Electronics for compliance could void the user's authority to operate this equipment.

CAUTION REGARDING PLACEMENT

To maintain proper ventilation, be sure to leave a space around the unit (from the largest outer dimensions including projections) equal to, or greater than, shown below.

Left and Right Panels: 10 cm

Rear Panel: 10 cm

Top Panel: 50 cm

IMPORTANT INFORMATION FOR UK CUSTOMERS

DO NOT cut off the mains plug from this equipment. If the plug fitted is not suitable for the power points in your home or the cable is too short to reach a power point, then obtain an appropriate safety approved extension lead or consult your dealer. If, nonetheless, the mains plug is cut off, **REMOVE THE FUSE** and dispose of the **PLUG** immediately, to avoid possible shock hazard by inadvertent connection to the mains supply. If this product is not provided with a mains plug, or one has to be fitted, then follow the instructions given below:

IMPORTANT

DO NOT make any connection to the larger terminal which is marked with the letter 'E' or by the safety earth symbol or coloured GREEN or GREEN AND YELLOW.

The wires in the mains lead on this product are coloured in accordance with the following code:

BLUE - NEUTRAL

BROWN - LIVE

As these colours may not correspond with the coloured markings identifying the terminals in your plug, proceed as follows:

The BLUE wire must be connected to the terminal marked with the letter 'N' or coloured BLACK.

The BROWN wire must be connected to the terminal marked with the letter 'L' or coloured RED

When replacing the fuse, only a correctly rated and approved type should be used, and be sure to re-fit the fuse cover.

IF IN DOUBT CONSULT A COMPETENT ELECTRICIAN

Introduction

SAFETY INFORMATION

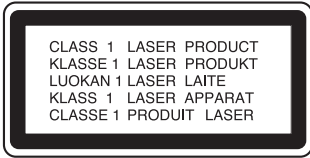

CAUTION

THIS DVD PLAYER EMPLOYS A LASER SYSTEM. TO ENSURE PROPER USE OF THIS PRODUCT, PLEASE READ THIS OWNER'S MANUAL CAREFULLY AND RETAIN FOR FUTURE REFERENCE. SHOULD THE UNIT REQUIRE MAINTENANCE, CONTACT AN AUTHORISED SERVICE LOCATION.

USE OF CONTROLS, ADJUSTMENTS TO MODIFY PERFORMANCE OF PROCEDURES OTHER THAN THOSE SPECIFIED MAY RESULT IN HAZARDOUS RADIATION EXPOSURE.

TO PREVENT DIRECT EXPOSURE TO LASER BEAM, DO NOT TRY TO OPEN THE ENCLOSURE. VISIBLE LASER RADIATION EXISTS WHEN THE ENCLOSURE IS OPENED. DO NOT STARE INTO BEAM.

THE APPARATUS SHOULD NOT BE EXPOSED TO DRIPPING OR SPLASHING LIQUIDS. OBJECTS FILLED WITH LIQUIDS, SUCH AS VASES, SHOULD NOT BE PLACED ON THE APPARATUS.

Do not place this unit on an unstable cart, stand or tripod, bracket or table. The unit may fall, causing serious injury to a child or adult and serious damage to the unit. Use only with a cart, stand, tripod, bracket or table recommended by the manufacturer or sold with the unit. Any mounting of the device on a wall or ceiling should follow the manufacturer's instructions and should use a mounting accessory recommended by the manufacturer.

An appliance and cart combination should be moved with care. Quick stops, excessive force and uneven surfaces may cause the appliance and cart combination to overturn.

WARNING: CHANGES OR MODIFICATIONS NOT EXPRESSLY APPROVED BY THE PARTY RESPONSIBLE FOR COMPLIANCE COULD VOID THE USER'S AUTHORITY TO OPERATE THE EQUIPMENT.

NOTE

The L73 is not an auto voltage DVD receiver. Connect only to the prescribed AC outlet, i.e., 120V 60Hz or 230V 50Hz.

The model and serial number of your new DVD receiver are located on the back of the cabinet. For your future convenience, we suggest that you record these numbers here:

RECORD YOUR MODEL NUMBER (NOW, WHILE YOU CAN SEE IT)

The model and serial number of your new DVD player are located on the back of the DVD player cabinet. For your future convenience, we suggest that you record these numbers here:

MODEL NO. _____
SERIAL NO.: _____

INTRODUCTION

Safety precautions	2-4
Table of contents	5
Getting the Most from the NAD L73	6
Unpacking and Setup	6
About the L73	6
E.A.R.S. and Digital Surround	6
Ease of Use	7
Upgradability	7
About the HTR L73 System Remote Control	7
Quickstart	7

IDENTIFICATION OF CONTROLS

front panel	8-9
rear panel	10-11

SETUP

Setting up the L73	12
Getting Started	12
Dealing With Hum and Noise	12
About the On-Screen Displays (OSD) and Front-Panel Readout ..	12
Displaying the L73 Receiver's OSD	13
Navigating the OSD and Making Changes	13
Setting L73 OSD Language (receiver section only)	13
Input Setup	13
Speaker configuration	15-16
SURROUND MODE	15
CHANNEL LEVELS	15
DELAY TIME	16

OPERATION

Using the L73	17
Selecting Sources	17
Adjusting the Volume	17
Muting the Sound	17
Using the L73's DVD/VCD/CD	18-22
About DVD/SVCD/VCD/CD	18
REGION MANAGEMENT INFORMATION	18
Transport Control Keys	18
Title and Menu buttons	19
OSD Navigation	19
video setup	19
Osd language	19
disc VIDEO OSD	20

disc AUDIO OSD	20
DISC language	20
PARENTAL control	21
Playing cd, vcd, svcd, dvd	21
Playing mp3 wma and jpeg cd-R/CD-RW	22

OPERATION

Using the L73's AM/FM radio	23-24
About Antennas	23
Selecting the Radio	23
Tuning Stations	23
Setting Radio Presets	23
Selecting Radio Presets	23
Choosing the FM Mute / Mode	24
About RDS	24
Viewing RDS Text	24
About the L73's SURROUND MODES	25-28
EARS	25
ENHANCED STEREO	25
STEREO	25
Dolby Digital / DTS	26
Selecting SURROUND MODEs	26
Dolby Virtual Speaker and Headphone	26
Adjusting SURROUND MODEs	27
Adjusting LEVEL TRIM "On the Fly"	28
Adjusting the Tone Controls	28
About the 12 V TRIGGER OUT	28
Using the HTR L73 Remote Control	29-34
Specifications	29
Controlling the L73	29
Learning Codes From Other Remotes	30
Punch-Through	30
Copy a Command From Another Key	31
Macro Commands	31
Recording Macros	31
Executing Macros	32
Key-Illumination Timeout	32
Factory Reset	32
Delete Mode	32
Loading Code-Libraries	33
Summary of HTR L73 Modes	34

REFERENCE

Troubleshooting	35
Specifications	36

THANK YOU FOR CHOOSING NAD

The L73 AV Surround Sound DVD Receiver is a technologically advanced and highly capable product-yet we have invested great effort in making it simple and easy to use. The L73 delivers a range of genuinely useful options for surround sound and stereo listening alike, using powerful digital signal processing and superbly accurate digital-audio circuitry. However, we have also been careful to ensure that the receiver is as musically transparent and spatially accurate as possible, incorporating much of what we've learned from a quarter-century's experience designing audio and home-theatre components. As with all our products, NAD's "Music First" design philosophy guided the L73's design, such that it can confidently promise you both state-of-the-art surround home-theatre and audiophile-quality music listening for years to come.

We encourage you to take a few minutes now to read right through this manual. Investing a little time here at the outset might save you a good deal of time later, and is by far the best way to ensure that you make the most of your investment in the NAD L73, and get the most from this powerful and flexible home-theatre component.

One more thing: We urge you to register your L73 ownership on the NAD Worldwide Web site:

<http://NADelectronics.com/w/Registration.html>

For warranty information contact your local distributor.

UNPACKING AND SETUP

WHAT'S IN THE BOX

Packed with your L73 receiver you will find:

- An AM loop antenna
- An FM ribbon-wire antenna with balun
- The HTR L73 remote control with 4 (four) AAA batteries
- This owner's manual

SAVE THE PACKAGING

Please save the box and all of the packaging in which your L73 arrived. Should you move or otherwise need to transport your receiver, this is by far the safest container in which to do so. We've seen too many otherwise perfect components damaged in transit for lack of a proper shipping carton, so please: Save that box!

CHOOSING A LOCATION

Choose a location that is well ventilated (with at least several inches to both sides and behind), and that will provide a clear line of sight, within 25 feet/8 meters, between the receiver's front panel and your primary listening/viewing position-this will ensure reliable infrared remote control communications. The L73 generates a modest amount of heat, but nothing that should trouble adjacent components. It is perfectly possible to stack the L73 atop other components, but the reverse usually should be avoided. Nonetheless, it is generally preferable that the L73 stands alone. It is especially important that sufficient ventilation be provided; if you are contemplating locating the L73 within a cabinet or other furniture, consult your NAD audio/video specialist for advice on providing adequate airflow.

ABOUT THE L73

Though the L73 is among the most technically sophisticated integrated A/V & DVD receivers, we worked hard to make it one of the most musically transparent home-theatre components available as well; this is what we mean by NAD's "Music First" design philosophy. Here are just a few examples:

- High-performance components used throughout the receiver's analog audio circuits maximize quality from all sources, including multichannel analog sources such as DVD-Audio.
- The L73 incorporates a high quality DVD player with exceptional playability. The player has support for DVD video and audio, VCD, SVCD with playback control (PBC), CD audio such as CD-RW as well as MP3. As with all NAD DVD players, a set of convenient navigation buttons is provided on the front panel. See "Front Panel Controls".
- Gold-surfaced connectors are employed throughout to ensure maximum signal integrity.

E.A.R.S. AND DIGITAL SURROUND

A key element of the L73's unique musical aptitude is NAD's proprietary Enhanced Ambience Recovery System (EARS). In sharp contrast to many "ambience-synthesis" music-surround modes, EARS exploits the L73's substantial DSP power to route the ambient content that is "encrypted" in virtually all natural-acoustic recordings to the appropriate main, centre and surround speakers, without resorting to artificially generated reflections or regeneration. EARS' natural ambience yields a subtle but exceptionally effective surround mode that naturally enhances the spatial presentation in a fashion suitable for serious music listening. Dolby ProLogic II Music, Movie and Emulation modes can also create enjoyable experiences from 2-channel sources.

On the digital side, the L73 combines extraordinarily high-speed DSP processing employing one of the most advanced high-speed DSP "engines" available, with fully 24-bit, 96 kHz-sampling-capable D/A converters for all channels. A single, high-precision master clock synchronises all digital circuits to eliminate the timing errors ("jitter") that otherwise compromise sonics. The result is legitimately state-of-the-art surround decoding from Dolby Digital and DTS sources, and 5.1-channel reproduction, with genuinely superior sound quality in all modes.

EASE OF USE

Despite the effort NAD has invested in the L73 receiver's sonic performance, we expended no less in making it powerfully easy to use. Its design is uniquely simple for so sophisticated a component, and the HTR L73 universal remote control is equally understandable, as are the L73's own front-panel and on-screen displays (OSD).

UPGRADABILITY

The L73 receiver permits flexible system growth via individually accessible 5.1 channel input for connectivity to products with integrated surround decoders.

See "Rear Panel (5.1 CH. INPUT)".

ABOUT THE HTR L73 SYSTEM REMOTE CONTROL

Packed with your L73 is the NAD HTR L73 remote control, a full-system remote especially designed to be easy to use and easy to understand. Be sure to read the section "Using the HTR L73 Remote Control," to familiarize yourself with the remote's layout and operations before proceeding to setup your receiver.

Chances are, you will want to use your HTR L73 as your primary way to command your entire A/V system. The HTR L73 can be employed to operate additional NAD or other-brand components such as a second DVD/CD player, television, satellite/HDTV tuner, VCR, or virtually anything else that operates via standard infrared remote control.

QUICKSTART

In case you simply cannot wait to experience the performance of your new NAD L73 DVD/Receiver, we provide the following "Quickstart" instructions to get you underway. The steps below connect your L73 to a TV/monitor; be sure to read "Input Setup".

PLAY A DVD MOVIE

- Connect the L73's composite video or S-Video "MONITOR OUT" jack to your TV/monitor's corresponding input.
- Connect your left and right front speakers to the L73's "FRONT L and R" outputs, being sure to connect red to red ("+") and black to black ("-"), with care to avoid stray wires or strands crossing between terminals. (Connect centre and surround speakers as well, if you like). If your system includes a powered subwoofer, connect the L73's "SUBWOOFER PRE-OUT" jack to its line input.
- Plug the AC mains plug into the AC; the LED on the front panel will be lit blue indicating the L73 is in standby mode ready to accept commands from either the front panel power switch or the HTR L73 remote.
- To start playback of the DVD player; press the HTR L73 remote's "DVD" Device Selector key, and then its transport key "Open/Close" to select the DVD, insert the media and press the transport ► play key to start playing. You should hear multichannel or stereo sound, and see an image on the TV/monitor. (If one or the other fails to appear, you may need to use either the L73's Receiver or DVD on-screen menu systems to check assignment of audio and video inputs; see "Input Setup".)

Enjoy the movie or music, but be sure to set aside time to read this manual thoroughly, and to set up, calibrate, and configure your L73 carefully and completely.

Identification of controls

FRONT PANEL

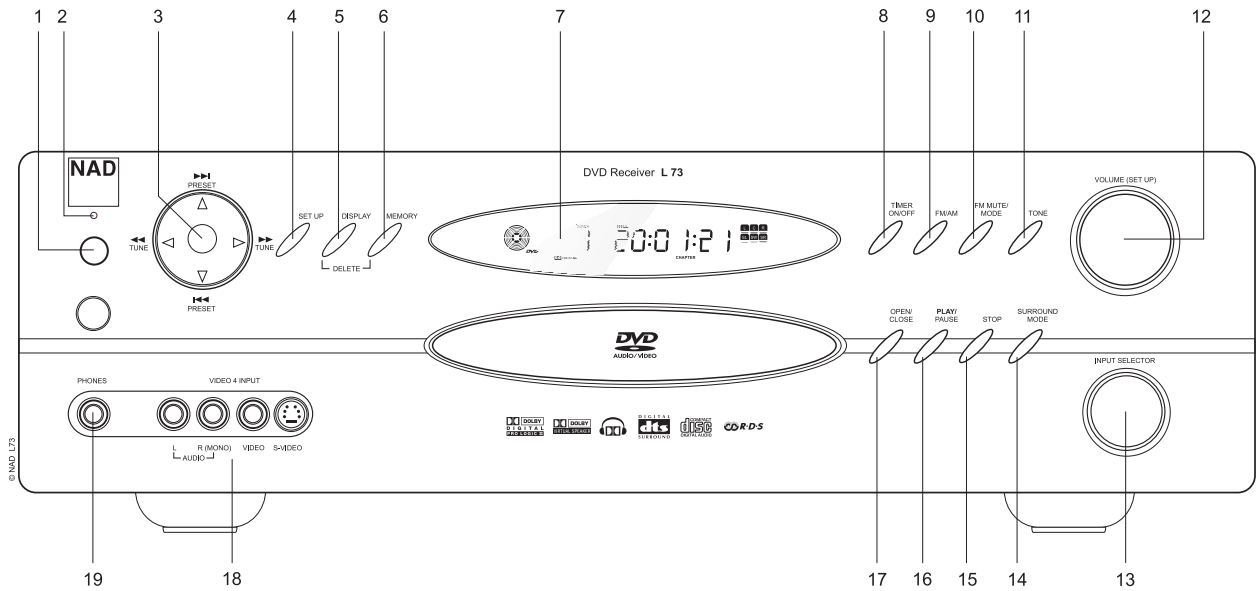

- 1 **“Power”**: When the L73 is first plugged into the AC power, the L73’s clock will light in the main VFL display showing the time of day, and very little power is consumed. Press in to switch the receiver from standby, changing the standby indicator to bright blue and illuminating the VFL display. Pressing the power switch again turns the unit back to standby. It is usual (and perfectly acceptable) to leave the L73 in standby mode in between normal viewing and listening sessions. Pressing the “OPEN CLOSE” button on the front-panel, or the HTR L73 remote’s “ON” button, will switch the receiver on, making it operational. Press the remote’s “OFF” button to return to standby. Note that when you do choose to switch off from standby using the front panel Power button, the L73’s memory back-up system will store channel level, tuner preset, and other settings for several weeks while the unit is switched off, or even unplugged from AC power altogether.
- 2 **INDICATOR**: When the L73 is in standby the LED will light bright blue, the VFL in the L73 will display the L73’s internal clock. This indicator will extinguish itself when the power cable is unplugged from the AC supply.
- 3 **PRESET TUNE**: Press to step up or down between radio presets or searching channels; 30 FM and 30 AM station presets are available. Note that this function “wraps”: Pressing ►► or ◀◀ will step from Preset 30 to Preset 1, or vice versa. “Unused” presets are skipped over. (Note that Presets must previously have been stored; see “Listening to Radio,” below.) Pressing momentarily the ►► or ◀◀ button will manually scan the AM or FM band. Press and hold the ►► or ◀◀ for more than 2 seconds to search up or down; the L73’s tuner will stop at the next sufficiently strong signal it encounters. Note that this function, too, “wraps,” and will continue searching up or down from one end of the AM or FM band to the other.
- 4 **SET UP**: Press momentarily for setup of the L73 via the OSD. Use this function in conjunction with your video monitor. This “SET UP” button is mode dependent, the DVD and receiver’s OSD are mutually exclusive. Press and hold “SET UP” to bring up the receiver OSD even when in DVD mode.
- 5 **DISPLAY**: Use this multifunction button to toggle between RDS PS, RDS RT and station frequency in FM Tuner mode (see Listening to Radio).
- 6 **MEMORY**: Use to store tuned stations to the L73’s 60 preset-memory locations. (See “Listening to Radio”.)
- 7 **VFL DISPLAY**: The Vacuum Fluorescent Display (VFL Display) provides visual information on all of the L73’s important modes, settings, and functions.
- 8 **TIME SET**: Press and hold to set the internal clock, ON/OFF timer, and display of the clock’s time. A red “clock face” will appear in the florescent display when the timer is activated. Use the “MEMORY” keys to toggle between the hours and minutes. There are two timers, one for when the L73 powers on, the other for when the unit powers off; these too are programmed in the same way as above.
- 9 **FM/AM**: Press to toggle between the tuner’s FM and AM bands.
- 10 **FM MUTE/MODE**: In the normal Mute position, only the stations with a strong signal can be listened to, and the noise between stations is muted. Pressing the “FM Mute/Mode” button allows distant (and potentially noisy) stations to be received. (See “Listening to Radio”.)
- 11 **TONE**: Press to toggle between Bass, Treble, TONE OFF and TONE ON. The VOLUME knob is used to adjust the Bass and Treble levels.
- 12 **VOLUME**: Turn clockwise to increase the master-volume setting; counter clockwise to lower it. The VFL and on-screen displays show the setting, displayed as increments between MIN, 1 to 77. The VOLUME knob is also used to increment/decrement the Bass and Treble levels.
- 13 **INPUT SELECTOR**: Use to select an audio/video input along with its assigned analog or digital inputs (see “Input Setup”). Rotate clockwise or counter clockwise to select between:
Internal DVD → External 5.1 → Internal AM/FM tuner → CABLE/SAT → VCR → VIDEO 4 → then back to Internal DVD

14 SURROUND MODE: Use to select the L73's SURROUND MODE. Press repeatedly to step through the L73's SURROUND MODEs. See "About the L73's SURROUND MODEs".

NOTE

- Depending on the format of the currently selected input (digital or analog; stereo or multichannel), different modes will be available. See "About the L73's SURROUND MODEs".
- For best results when recording to a VCR, select "SURROUND: STEREO", and SUB: OFF in the receiver's setup OSD.

15 STOP: Press this button to stop playing of a DVD/CD.

16 PLAY/PAUSE: Press this button to toggle between Play and Pause of a DVD/CD.

17 OPEN/CLOSE: Press this button to open and close the DVD/CD drawer and simultaneously select the internal DVD/CD player. When in standby, this button will also power On the L73.

18 VIDEO 4 INPUT: Use these convenience jacks for occasional sources, such as a camcorder, portable MP3 or tape player, or a videogame console, or any other analog audio, or composite or S-Video video source. Select the Video 4 input using the HTR L73 remote, or the front-panel INPUT SELECTOR knob.

19 PHONES: Accepts stereo headphone using a standard 1/4-inch stereo phone plug (use a suitable adaptor for headphones equipped with a smaller plug). Plugging in headphones automatically mutes output from all channels' speakers (but not from the AUDIO OUT jacks of the VCR).

Identification of controls

REAR PANEL

ATTENTION!

Please make all connections to your L73 receiver with the unit unplugged. (It is also advisable to power-down or unplug all associated components while making or breaking any signal or AC power connections.)

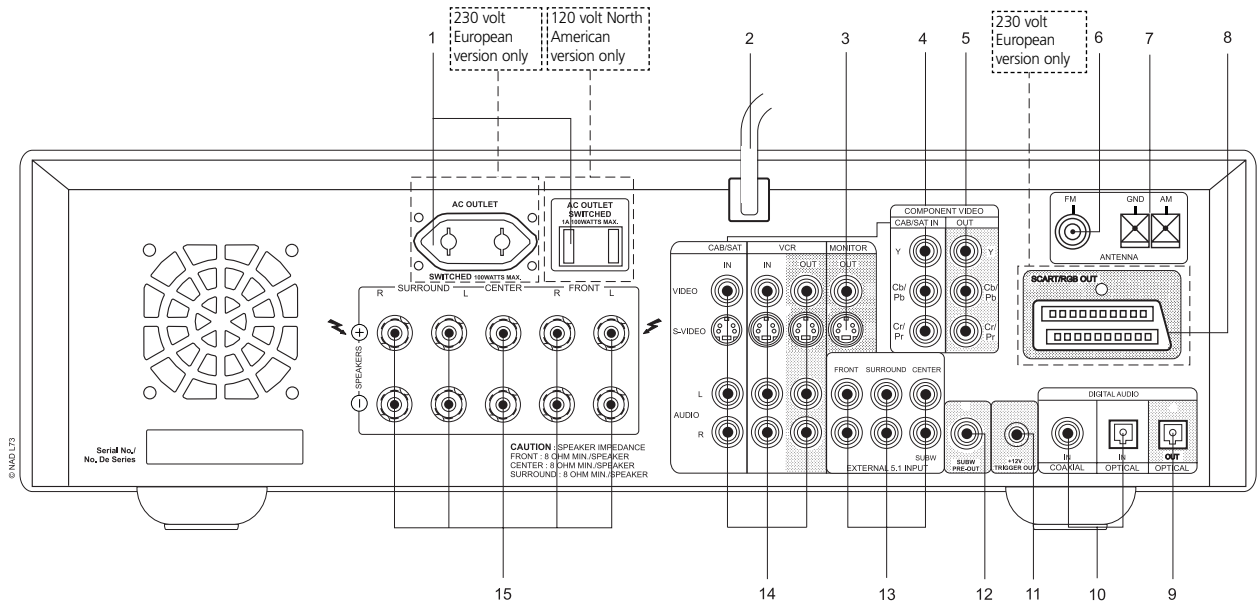

- 1 SWITCHED AC OUTLET:** This convenience jack can supply switched power to another component or accessory. It is powered on and off by the front panel POWER key (or the HTR L73's ON and OFF keys).

NOTE

The total draw of all devices connected to this jack must not exceed 100 watts.

- 2 AC POWER CORD:** Connect AC power cord to the Voltage according to the model, 120 V for US and 240 V for Euro models.

- 3 MONITOR OUT:** Connect to video input of the monitor/television, using quality dual-RCA and/or S-Video cables designed for video signals. In general, the S-Video connection is superior and should be used if your TV/monitor provides the corresponding input.

- 4 COMPONENT VIDEO IN:** Connect inputs to component-video signal or wide-band component video from a source component such as a HDTV tuner.

- 5 COMPONENT VIDEO OUT:** Connect the L73 COMPONENT VIDEO OUT to the component-video input of a compatible video monitor/TV. Be sure to observe consistency in connecting the Y/Cr/Cb jacks (some source and TV components label these Y/Pb/Pr) to the corresponding sources/inputs; do not rely purely on the colour coding of the jacks, which may not always be consistent among brands. The routing of the component-video input is fixed: COMPONENT VIDEO OUT jack will only display the internal DVD and CAB/SAT video signals.

NOTE

The L73's component-video output is a fully wide-band output, compatible with all HDTV formats. The L73 will display its on-screen menus on its component-video output.

- 6 FM ANTENNA:** The supplied wire "dipole" FM antenna will connect to the FM connector using the supplied "balun" adaptor. It will usually work best when mounted on a vertical surface such as a wall, with arms fully outstretched forming a horizontal "T" perpendicular to the origin point of the signal. Experiment with placement and orientation of to yield the clearest sound and lowest background noise. In areas of difficult FM reception an external FM antenna can yield dramatic gains in quality; consult your NAD audio specialist or a professional antenna installer.

- 7 AM ANTENNA:** The AM loop antenna supplied with the L73 (or a suitable replacement) is required for AM reception. Open the clip terminal lever; insert the wire and close, ensuring that the lever locks the wire in place. Testing different positions for the antenna may improve reception; vertical orientation will usually produce the best results. Antenna proximity to large metal objects (appliances; radiators) may impair reception, as will attempts to lengthen the wire to the loop.

NOTE

An external AM antenna can improve long-distance reception substantially; consult your NAD audio specialist or a professional antenna installer. Do not connect anything other than a loop antenna to the AM ANTENNA terminal. Do not remove the AM loop antenna.

8 SCART/RGB VIDEO OUT (PAL only): Connect the L73 SCART/RGB VIDEO OUT to the SCART/RGB video input of a compatible video monitor/TV. Be sure to observe the correct orientation of the SCART/RGB plug. The routing of the SCART/RGB input is fixed: SCART/RGB plug will only display the internal DVD video signals.

9 OPTICAL OUT: Connect the OUT OPTICAL port to the corresponding S/PDIF digital input of a recording component such as a CD recorder, DAT deck, or computer soundcard. See "Setup."

10 OPTICAL & COAXIAL IN: Connect to the coaxial/optical S/PDIF-format digital output of sources such as VCRs, HDTV or satellite tuners, or other components; connect IN OPTICAL/COAXIAL to an S/PDIF-format digital output.

11 12 V TRIGGER OUT: This mini-jack will control on or off any auxiliary equipment with a 12V trigger input when the L73 switches from standby to on state respectively. The maximum current this output can handle is 50 mA at 12 V. Consult your NAD audio specialist for more information.

12 PRE-OUT SUBWOOFER: Connect this output to a powered ("active") subwoofer (or to a power amplifier channel driving a passive system).

13 5.1 CHANNEL INPUT: Connect to the corresponding analog audio outputs of a multichannel source component such as a DVD-Audio or multichannel-SACD player, or external multichannel decoder.

NOTE

There is no bass-management or other processing (other than master-volume control) available to this 5.1 CHANNEL INPUT. While the multi-channel audio outputs of a DVD-Video player can be connected to these jacks, using the L73's own Dolby Digital and DTS decoding and digital-analog converters, via a digital connection, can usually produce superior results.

14 CABLE/SAT & VCR: These comprise the L73's principal inputs. Connect S-Video, composite video, and analog stereo audio from source components such as HDTV/satellite tuners (see "Setup"). VCR may be used with recording components such as videocassette or DVD-recorders; connect the L73 S-Video/composite video OUT jacks to these components' record-input. (Note that VCR may freely be used for play-only components, in which case their IN jacks would remain unconnected.)

NOTE

For best results when recording to a VCR, select "SURROUND: STEREO", and SUB: OFF in the receiver's setup OSD.

15 SPEAKERS: Connect the left and right front, centre, and left and right surround speaker outputs to the corresponding loudspeakers. Each output's "+" (red) terminal and "-" (black) terminal must be connected to the corresponding "+" and "-" terminals of the loudspeaker. Use extra care to ensure that no stray wires or strands cross between posts or terminals at either end.

NOTE

- *Use stranded wire of at least 16-gauge (AWG); specialized speaker cable may be valuable (consult your NAD audio specialist). Connections to the L73 can be made with banana-type plugs, or using bare wire, or pins, by loosening the terminal's plastic nut, making a clean, neat connection, and re-tightening carefully (use the transverse hole through the post for bare-wire or pin connections). To minimize the danger of short-circuits, ensure that only 1/2-inch of exposed wire or pin is employed in connecting.*
- *This unit is designed to produce optimum sound quality when connected to speakers with impedances within the receiver's operating range. Please check front, centre, and surround speakers are rated to be 8 Ohms min. per speaker.*

IMPORTANT NOTE

For optimum surround performance, the L73 SPEAKER CONFIGURATION and levels must be set correctly via the receiver's setup routines; see "SPEAKER CONFIGURATION."

GETTING STARTED

Before you make the first connection to your L73, you should have the arrangement of your listening room/home theatre components and furniture mapped out, at least initially. Unfortunately, a discussion of the vital questions of loudspeaker placement and listening/viewing positions is beyond our scope here. Suffice it to say that these two questions will influence your system's ultimate performance every bit as powerfully as your selection of electronics and speakers. Your NAD audio specialist dealer will be happy to advise you, and to recommend reference materials.

NOTE

It is not absolutely necessary but one may find it easier to use the HTR L73 remote handset in conjunction with the front panel buttons to configure your L73. See "Using the HTR L73 Remote".

DEALING WITH HUM AND NOISE

Hum and noise sometimes prove a challenge in complex, multichannel audio systems. Note these considerations to help prevent hum and noise problems:

- Power your system's entire audio components from AC outlets originating from the same circuit of your house wiring. As far as possible, power all audio components from the same outlet, or adjacent outlets on the same circuit. It may be useful to power video displays (and computers!) from outlets on another circuit, especially if that circuit is supplied from the other "leg" of the house wiring.
- Do not bundle analog audio cables with AC power cables, or with coaxial digital-audio cables. It is best if they cross at right angles if they must be in close proximity.
- Employ high-quality, well-shielded audio cable throughout, and ensure that all connections are secure.
- A pencil-eraser can be used to burnish copper- and gold-plated contacts to ensure good, low-resistance contact; specialized contact-cleaners can also be useful. Avoid unnecessary unplugging and re-plugging, since the gold (or copper) contact plating of typical cable connectors, even very high-quality ones, is very thin and easily worn.

Track down hum/noise problems one component at a time, working backwards from the receiver. That is: Connect the speakers to the receiver only, and check for hum. Then connect one component only (a VCR, for example) alone, with no other components connected and check for hum. Connect additional components, one at a time, to the receiver and check for hum. At each stage, if hum/noise appears, examine the audio cabling and AC-power routing of the new component. In some cases, moving the new component's AC cord to a different outlet, or installing a ground-lift (3-to-2-prong adaptor) on its power cord, will eliminate the hum.

ABOUT THE ON-SCREEN DISPLAYS (OSD) AND FRONT-PANEL READOUT

The L73 receiver employs two; self-explanatory systems of on-screen display "menus" one for the L73 receiver, the other for the internal DVD player. These "menus" will appear on the connected video monitor/TV and are required during the setup process (useful in day-to-day operation); so be sure to connect the monitor/TV before proceeding with setup.

DISPLAYING THE L73 RECEIVER'S OSD

While in DVD mode, press the L73's "SETUP" key momentarily for the DVD's OSD, and for 3 seconds for the receiver's OSD. With the use of the navigation keys either on the L73's front panel or the HTR L73 remote, you may select various menus. For the L73's receiver, the <AUDIO SETUP MENU> will display on your video monitor/TV.

NAVIGATING THE OSD AND MAKING CHANGES

Press the SETUP button on the front panel of the L73 as described above in "Displaying the L73 Receiver's OSD". Use the ▲/▼ keys of the HTR L73 or on the front panel, to move up or down among the Setup menu's list of items; use "Enter" to select a menu item, and use ◀/▶ to change the parameter-value (setting) of any item. Selecting <SAVE AND EXIT> from the main setup menu exits the OSD altogether, retaining parameter-value changes, if any, made previously.

When in the DVD OSD, pressing the "SETUP" button on the L73 will toggle off the dedicated DVD OSD and at that moment the DVD settings will be stored.

NOTE

When playing any DVD, VCD, or CD the L73's DVD OSD can be activated at any time. This convenient feature allows one to change audio and video settings "on-the-fly" without the need to stop or pause the media.

SETTING L73 OSD LANGUAGE (RECEIVER SECTION ONLY)

From the OSD's <SETUP MENU> screen, select the <OSD LANGUAGE> item using the remote's ▲/▼ and "Enter" keys. Using the ▲/▼ keys, select between English, French, German, Dutch, Spanish, Italian, Portuguese, Swedish for the L73's receiver OSD.

INPUT SETUP

The L73 is equipped with four configurable inputs; 3 audio-video inputs labelled CAB/SAT, VCR, and VIDEO 4 (VIDEO 4 on the front panel), and one set of audio-only labelled 5.1 CHANNEL INPUT. These will become active whenever that input is selected.

NOTE

Incoming digital and audio signals present at either digital (either coaxial or optical) or analog inputs are mutually exclusive.

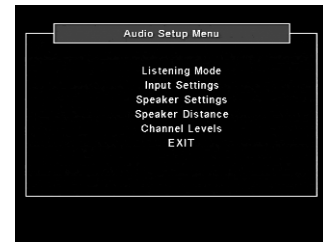

Setup

SETTING UP THE L73



INPUT SELECTOR

- From the OSD's <AUDIO SETUP MENU> screen, select the <INPUT SETTINGS> menu item using the HTR L73 remotes' ▲/▼ and "Enter" keys.
- Using the ◀/▶ keys select the video input (DVD, SAT, VCR, and VIDEO 4) you wish to configure.
- Use the ▲/▼ keys to move to the <AUDIO IN> line, and then use the ◀/▶ keys to select the analog audio input you wish to be linked to that input (usually, this will be the same, i.e., "VCR" with "VCR," "Video 4" with "Video 4," and so on).

NOTE

It is not necessary to have an analog audio input connected for every video input you employ. In fact, in some cases—for example for a CAB/SAT—it may be preferable to make only a coaxial or optical digital audio link to the L73 for audio playback. This avoids possible confusion, and ensures that the L73's high-performance surround and digital audio circuitry will always be employed.



- Now use the ▲/▼ keys to move to the <DIGITAL INPUT> line and select the digital input you wish linked to that input.
- If you set <DIGITAL INPUT> to "ANALOG," no incoming digital signal will be selected by that input. (Set an input's <DIGITAL INPUT> to "ANALOG" only if you wish to ensure that that input will not play an incoming digital bit stream, even if one is present.)

NOTE

- *That signals from digital inputs are not available on the analog VCR OUT jacks.*

Every surround-sound system requires “bass-management” to direct low-frequency content from any or all channels to the speakers best able to reproduce it. For this function to operate correctly, it is important that you correctly identify your speakers’ capabilities.

We use the terms “SMALL”, “LARGE”, “NONE”, (and OFF), but note that physical size may be irrelevant.

- A “SMALL” speaker is any model, regardless of physical size, that lacks significant deep-bass response, that is, below about 80 Hz.
- A “LARGE” speaker is any full-range model, that is, one with deep-bass response
- A “NONE” speaker is one that is not present in your system. For example, you might not have any surround-back speakers installed; in that case, you would set the <SURROUND> setup item to “NONE.”
- An “OFF” speaker is one that may be present such as a subwoofer but set to off in the <SPEAKER SETTINGS> setup menu such as <SUBWOOFER: OFF>.

SETTING SPEAKER CONFIGURATION

From the OSD’s <AUDIO SETUP MENU> screen, select the <SPEAKER SETTINGS> line using the HTR L73 remote’s ▲/▼, and “ENTER” keys. Using the ◀/▶ keys, set <FRONT:> to “LARGE” or “SMALL” as your main-front speakers require according to the guidelines noted above. Similarly, set <CENTER>, and <SURROUND> to “LARGE,” “SMALL,” or “NONE” as your system’s loudspeakers require. Set <SUBWOOFER> to “ON” or “OFF.”

NOTE

- The *SPEAKER CONFIGURATION* is “global”; that is, it remains in force with all inputs and in all *SURROUND MODES*.
- You can set Subwoofer to “ON” even with “LARGE” front speakers. In such cases, both subwoofer and front speaker will receive the LFE-channel signal. In the case where the front speakers are set to “SMALL” the LFE-channel signal will be routed to subwoofer but not to the front speakers; LFE-channel signal will pass only to the subwoofer. In most subwoofer-equipped systems, setting front speakers to “SMALL” is usually the better option.

SURROUND MODE

From the OSD’s <AUDIO SETUP MENU> screen, select the <LISTENING MODE> line using the HTR L73 remote’s ▲/▼, and “Enter” keys. Using the ▲/▼ and ◀/▶ keys you can select mode variations, and adjust various parameters, depending on the current SURROUND MODE. For more information, see “About the L73’s SURROUND MODEs,” below.

CHANNEL LEVELS

Adjusting the relative balance of your system’s loudspeakers ensures that surround-sound recordings, whether music or film, will present the balance of effects, music, and dialog that the artists intended. Additionally, if your system incorporates a subwoofer it establishes a correct relationship between the volume of the subwoofer and the other speakers, and thus of low-frequencies (bass) to other sonic elements.

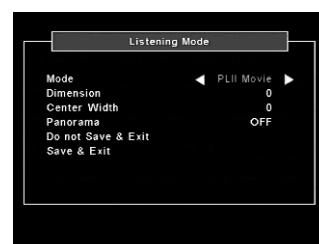
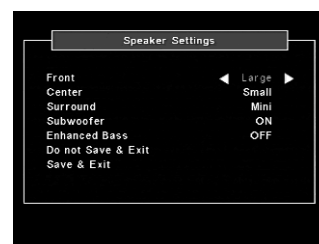

Setup

SPEAKER CONFIGURATION

ENGLISH



SETTING LEVEL TRIM

Press the HTR L73 remote's "TEST" key, activating the L73's channel-balancing test signal and displaying the <TEST TONE> menu on the OSD. You will hear a "surf" sound that cycles through your speakers, beginning with the Front-Left. (If you do not hear the test signal, check your speaker connections (above), and your <SPEAKER SETTINGS> OSD menu settings, (above).)

As the test signal cycles around the speakers, the OSD (and the VFL front panel display) will highlight the currently playing channel. Now use the remote's ◀/▶ keys to adjust the loudness of the noise output from the currently playing channel to the required level (it's usually simplest to begin with the left-front). The "level offset" reading on the right will change by 1 dB increments; ±10 dB adjustment is available.

NOTE

- If you are balancing levels "by ear," choose one speaker – usually the centre – as a reference and adjust each of the others in turn to "sound as loud" as the reference. Be sure that you remain in the primary listening position while balancing all channels.
- All speakers must be in their final locations before level setting.
- Your subwoofer (if any) should be set with its integral crossover defeated, or if undefeatable, set to its highest-possible frequency if you are using the L73's SUBWOOFER output. Final subwoofer-level adjustment "by-ear," using music and film sound material, is frequently useful.
- Due to the effects of room acoustics, matched-pair speakers (front; surround; back) will not always calibrate to exactly the same level offset readings.



DELAY TIME

Your system's SPEAKER CONFIGURATION settings are a subtle but important refinement of your setup. Informing the L73 of the loudspeaker-to-listener dimensions of each speaker automatically imposes the correct delays, optimising imaging, intelligibility, and surround-sound ambience.

SETTING SPEAKER DELAY TIME

From the OSD's <AUDIO SETUP MENU> screen, select the <LISTENING MODE> item using the remote's ▲/▼ and "Enter" keys. Using the ◀/▶ keys, select the surround mode you wish to configure. From your principal listening position to the front surface of the centre loudspeaker select the amount of delay for that particular surround mode. The delay in milliseconds roughly represents the distance in feet; one millisecond is approximately one foot.

You may operate the L73 DVD Surround Sound Receiver from its front panel or via the HTR L73 remote control. Since the remote will be the primary controller for most cases, we will focus on remote-controlled operations. Be sure also to read the section, "Front Panel" above.

SELECTING SOURCES

With the HTR L73's remote's "Amp" device selected, the remote's numeric-key section directly selects the receiver's internal DVD and tuner "TUNER", as well as the other inputs and multichannel input ("Ext. 5.1") refer to the orange labels directly above each key.

- When a source other than the internal DVD is selected, the video signal at the monitor output is always a black background, until the internal DVD is selected.
- When you change sources, the VFL will display the new input in its primary display.

ADJUSTING THE VOLUME

Use the HTR L73 remote's <Volume up/down> keys to adjust the "master volume" of the L73, raising or lower all channels together.

NOTE

- *A momentary keypress will change the master volume by 1 unit increments; if you hold down <Volume up/down> the master-volume change will "run-on" until the key is released.*
- *The L73's OSD will show the volume setting as a line graphic with a numeric display above relative to the reference level.*

Since recordings vary considerably in overall average level, there is no imperative to listen at any particular master-volume setting. A setting of 20 may sound "as loud" from one CD or DVD as 10 does from another.

- If muting has been activated (below), adjusting master-volume via the HTR L73 remote or the front-panel knob automatically releases the mute function.
- The L73 will power-up from standby mode at whatever master volume setting was last used; however, if the prior setting was greater than 50 the L73 will power up to 50. This prevents inadvertently beginning a session at excessive volume.

MUTING THE SOUND

Use the HTR L73 remote's <Mute> key to silence all channels completely. Muting is always available, regardless of source or SURROUND MODE selections.

NOTE

- *Cycling through standby or powering off releases muting; the L73 will return from standby with muting off if standby was invoked with muting on.*
- *A changing input or listening-mode selection releases muting.*
- *Adjusting the master-volume via the HTR L73 or the front-panel knob automatically releases the mute function.*

PRESS "OPEN/CLOSE"; THE DISC TRAY OPENS.

- You can open the disc tray by pressing this button even if the L73 is in standby mode. The power indicator will turn from blue to dark. Place a disc on the disc tray with the playback side down.
- There are two different disc sizes. Place the disc in the correct guide on the disc tray. If the disc is out of the guide, it may damage the disc and cause the L73 to malfunction.
- Press "PLAY/PAUSE", the disc tray is automatically closed and playback begins.
- If the disc is placed in upside down (and it is a single sided disc), 'NO DISC' appears on both the L73's display and the TV/monitor screen.
- If you insert an audio CD or VCD, the total tracks and time will appear.
- If you insert a SVCD videodisc, the PBC symbol (Play Back Control) will appear in the L73's display and OSD. The "TITLE" button on the HTR L73 will toggle on and off PBC.
- After playing back all of the chapters in the title, L73's DVD player automatically stops and returns to the menu screen.

Press the HTR L73's navigation buttons then and press "ENTER", or press the numeric button(s), to select the desired item. Play of the selected item now begins.

For further information, also refer to the jacket or case of the disc you are playing.

NOTES

- Do not move the L73 during playback. Doing so may damage the disc and the L73.
- Do not push the disc tray while it is moving. Doing so may cause the L73 to malfunction.
- Do not push up the disc tray or put any objects other than discs on the disc tray. Doing so may cause the L73 to malfunction.
- Keep your fingers well clear of the disc tray as it is closing. Be especially careful with children's fingers around the closing disc tray, as there is a risk of personal injury.
- Depending on the DVD disc, some operations may be different or restricted. Refer to the jacket or case of the disc you are playing.

ABOUT DVD/SVCD/VCD/CD

The L73's internal DVD/SVCD/VCD/CD player will play DVDs, SVCD with or without PBC (Play Back Control), VCDs, and CDs including CD-R, CD-RW, and MP3. To turn on or off PBC, toggle the "TITLE" button on the HTR L73.

NOTE

- You cannot playback discs other than those listed above such as Video CD-CD-ROM, CD-Extra, CD-G, photo-CD, and CD-i data discs. To do so may render the L73 permanently inoperable.

REGION MANAGEMENT INFORMATION

This DVD Player is designed and manufactured to respond to the Region Management Information that is recorded on a DVD disc. If the Region number described on the DVD disc does not correspond to the Region number of this DVD player, this DVD player cannot play that disc.

NOTE

- There are two regions for the L73, Region 1 and Region 2 as shown on the back of the L73.

TRANSPORT CONTROL KEYS

These keys are found on both on the L73 front panel and HTR L73. On the L73 they are the "Open/Close", "Play/Pause", "Stop", ◀◀, ▶▶, ◀◀▶▶, and ▶▶▶▶ keys. On the HTR L73 these are ▲, ■, ||, ◀◀▶▶, ▶▶, and ▶▶▶▶.

TITLE AND MENU BUTTONS

Both these buttons are only found on the HTR L73. Both "TITLE" and "MENU" buttons are used to display via OSD, the title headings and menus of the DVD and MP3 CD media when available.

Some movie discs may contain two or more titles. If the disc has a title menu recorded on it, the "TITLE" button can be used to select the movie title. (The details of operation differ depending on the disc used.)

NOTE

- *Selecting a title may not be possible on certain DVD discs.*
- *Press "TITLE"; a list of the titles on the disc is displayed. Press "TITLE" again to resume play from the scene when "TITLE" was first pressed*
- *Press "ENTER", "PLAY", or the numeric button(s), to select desired title. The selected title now starts playing.*
- *Depending on the DVD-A disc, some operations may be different or restricted. Refer to the jacket or case of the disc you are playing.*

Some DVDs have unique menu structures called DVD menus. For example, DVDs programmed with complex contents provide guide menus, and those recorded with various languages provide menus for audio and subtitle language. Although the DVD menu's contents and operation differ from disc to disc, the following explains the basic operation when this feature is used.

Press "MENU" during play; the DVD menu available on the disc is now displayed. Pressing "MENU" again resumes play from the scene when MENU was first pressed.

OSD NAVIGATION

Perform the L73's DVD OSD navigation by using the L73's "SETUP/MEMORY", and the HTR L73's navigation ▲/▼/◀/▶, buttons with the "ENTER" button; before performing OSD navigation connect the L73 to a TV/monitor.

During playback of DVD, VCD, and CD media the HTR L73's display button "DISP" will enable an OSD for navigation of time/tracks/chapters (media specific), audio language (DVD, and SVCD only), subtitle language (DVD only), angles (DVD only), and surround sound configuration.

NOTE

- The display feature may not be available for all disc media and is media dependent.
- The HTR L73's Display button toggles between time/track/chapters and subtitle/angles/surround sound configuration for (DVD only).

VIDEO SETUP

VIDEO SETUP MENU

Select this menu to enter the DVD-player's options menu

OSD LANGUAGE

Select this menu to enter the OSD language menu.

EXIT

Select this to exit the OSD.

OSD LANGUAGE

To select the OSD language for the L73. From the OSD menu select 'OSD Language' and then toggle through to the required language; Select between English, French, German, Dutch, Spanish, Italian, Portuguese, Swedish. To save the setting select "Save and Exit"



Operation

USING THE L73'S DVD/VCD/CD

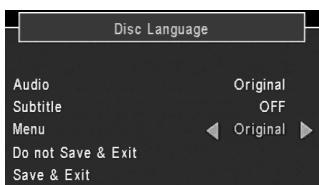
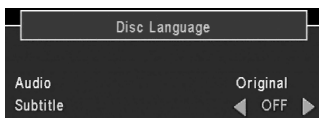
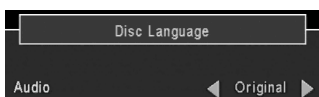
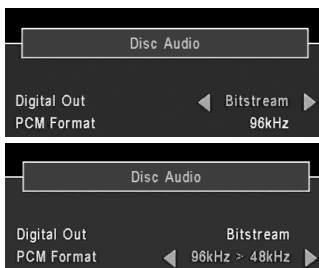
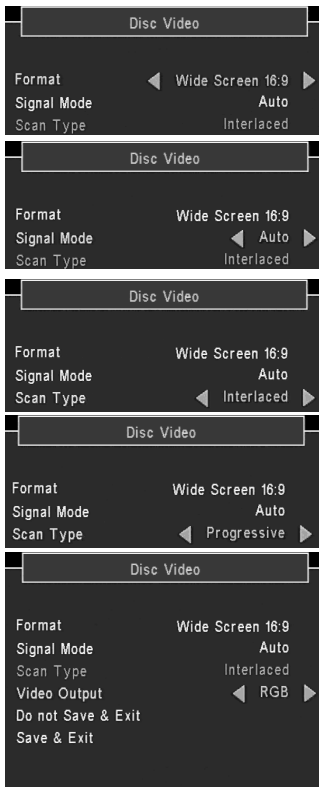

DISC VIDEO OSD

To select the appropriate screen type according to your TV set, one selects the "SETUP/MEMORY" button from the L73's front panel. Choose "DISC VIDEO" and select choices that best fit your TV set.

FORMAT

Select between Letter Box 4:3, Pan Scan 4:3, and Wide Screen 16:9 using either the navigation, or the "ENTER" buttons to select. To save the setting select "Save and Exit"

SIGNAL MODE

Use the navigation or the "ENTER" buttons to select between NTSC, PAL or AUTO depending on your TV/monitor configuration/type. To save the setting select "Save and Exit"

SCAN TYPE

Use the navigation or the "ENTER" buttons to select between "Interlaced" and "Progressive" scan types, depending on your TV/monitor configuration/type. To save the setting select "Save and Exit"

NOTE

- One can also use the L73's front panel "DISPLAY:" button to toggle between Progressive and Interlaced scan. Hold in the "DISPLAY" button for greater than 8 seconds to toggle between the scan types.
- Progressive scan is not available for RGB output.

VIDEO OUTPUT (230V ONLY)

Use the navigation or the "ENTER" buttons to select between RGB (SCART Video Out) and YUV (Component Video Out) depending on your TV/monitor configuration. To save the setting select "Save and Exit"

NOTE

- RGB is not available when Progressive scan is selected.

DISC AUDIO OSD

Depending on the media played, audio may not be present unless the "AUDIO OUT" is set to either "PCM" or "Bitstream". Please refer to your DVD/CD media documentation for the correct settings.

DIGITAL OUT

Select between "PCM" and "Bitstream" at the L73's "DIGITAL OUT" to other audio/video equipment using the navigation or the "ENTER" buttons to select. To save the setting select "Save and Exit"

PCM FORMAT

Select between "96kHz" or "96kHz > 48kHz" using the navigation or the "ENTER" buttons to select. To save the setting select "Save and Exit"

DISC LANGUAGE

Depending on the DVD media, only those languages recorded on the DVD media are available. When these settings are chosen, they will become default settings, unless the DVD media overrides the settings.

AUDIO

Select between English, French, German, Dutch, Spanish, Italian, Portuguese, Swedish and Original for the DVD disc audio using the navigation or the "ENTER" button to select. To save the setting select "Save and Exit"

SUBTITLE

Select between English, French, German, Dutch, Spanish, Italian, Portuguese, Swedish, and OFF for the DVD disc subtitles using the navigation or the "ENTER" button to select. To save the setting select "Save and Exit"

MENU

Select between English, French, German, Dutch, Spanish, Italian, Portuguese, Swedish, and Original for the DVD disc menus using the navigation or the "ENTER" button to select. To save the setting select "Save and Exit"

PARENTAL CONTROL

PASSWORD

Select PASSWORD to change a four digit password, using the numeric buttons on the HTR L73's remote control. The first time you input a password, use the factory default password 1234.

RATING LEVEL

Select between 1 to 8 or "Unlock" to limit the viewing of DVD media only, by using the "ENTER" button to select. The value of "Unlock" represents full access to all rating types of DVDs; the value of 1 represents total restriction of DVDs limited to family entertainment. To save the setting select "Save and Exit"

NOTE:

- If you have forgotten your password, see "TROUBLESHOOTING" to restore factory default password.

PLAYING CD, VCD, SVCD, DVD

PROGRAMMING (CD VCD SVCD)

When programming a sequence of tracks or chapters, the L73 must be in stop mode. To program the sequence; press the HTR L73's "PROGRAM" button to enter program mode, then use the number buttons to source the file, then "ENTER" to load the file into the program. Load up to 100 CD-tracks or chapters into a program sequence. Press the "CLEAR" button to clear the last track or chapter. Press the "PLAY" button to lock and start the program sequence.

RANDOM PLAY (CD VCD SVCD)

Press the HTR L73's "RANDOM" button for random playback of CD-tracks or chapters. The random feature will clear any program sequence.

NOTE

- For SVCD, and VCD with PBC, turn off the PBC using the "TITLE" button on the HTR L73 to enable the random function.

REPEAT (CD VCD SVCD DVD)

Press the HTR L73's "REPEAT" button; once for repeating a single CD-track or chapters, a second time to repeat the all tracks or chapters, and a third time to turn off repeat. The OSD and VFD will display the repeat mode. The repeat feature will clear the program sequence.

REPEAT A-B (CD VCD SVCD DVD)

Press the HTR L73's "REPEAT A-B" button once to set the start of the repeat function. Press it a second time to set the end point of the repeat function. Press it a third time to cancel the repeat function.

NOTE

- For SVCD, and VCD with PBC, turn off the PBC using the "TITLE" button on the HTR L73 to enable the repeat function.

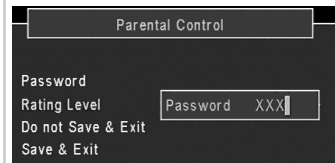
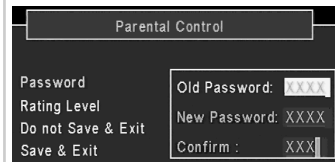

PROGRAM P01 : 02

RANDOM OFF

RANDOM ON

REPEAT - ONE

REPEAT - ALL

CHAPTER REPEAT ON

TITLE REPEAT ON

REPEAT OFF

Operation

USING THE L73'S DVD/VCD/CD

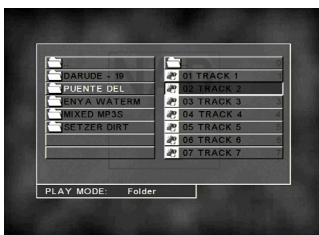
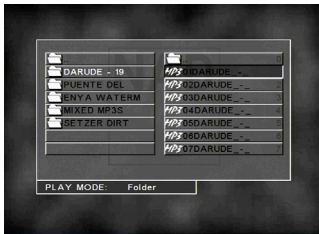
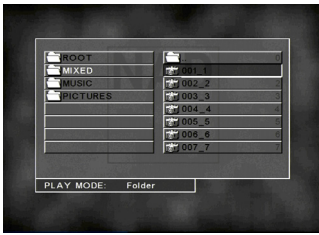

PLAYING MP3 WMA AND JPEG CD-R/CD-RW

Load CD. The OSD will display the folders or files as a list. For each file type; MP3, WMA, and JPEG, the L73's VFD will display the file type. You may mix any of the file types on the CD. When playing the media, the HTR-L73's "DISP" button toggles the time display between "Chapter Elapsed", "Chapter Remain", and "OFF."

When in stop mode, pressing the "DISP" button will open a "PROPERTIES" menu for the each media type. Press the "DISP" button a second time to close the "PROPERTIES" menu.



RANDOM PLAY

Press the HTR L73's "RANDOM" button for random playback of files or CD-tracks. The random feature will clear any program sequence.

NOTE

- For SVCD, and VCD with PBC, turn off the PBC using the "TITLE" button on the HTR L73 to enable the random function.

REPEAT

Press the HTR L73's "REPEAT" button; once for repeating a single file or CD-track, a second time to repeat the entire file folder or all tracks on a CD, and a third time to turn off repeat. The OSD and VFD will display the repeat mode. The repeat feature will clear the program sequence.

NOTE

- For SVCD, and VCD with PBC, turn off the PBC using the "TITLE" button on the HTR L73 to enable the repeat function.

SLIDE SHOW MODE (JPEG)

There are 12 transition modes for photo images. Press the "RTN" button on the HTR L73 to select the transition between scenes. The last transition mode is a random selection of slide show modes.

The L73's internal AM/FM tuner offers very high quality sound from radio broadcasts. Note that reception and sound quality will always be dependent to a degree on the type of antenna(s) used, as well as proximity to the broadcast origin, geography, and weather conditions.

ABOUT ANTENNAS

The supplied ribbon-wire FM antenna can be connected to the rear-panel FM-antenna input using the 'balun' included adaptor, and should be fully extended to form a "T". This folded-dipole antenna will usually work best oriented vertically, with the arms of its "T" full outstretched and arranged perpendicular to the origin of the desired broadcast. There are no 'rules,' however, and experimenting freely with antenna placement and orientation may yield the clearest sound and lowest background noise. In areas of poor FM reception, an exterior FM antenna can improve performance dramatically. If radio listening is important to you, consider consulting an antenna installation professional to optimise your system.

The supplied AM 'loop' antenna will usually provide adequate reception. However, an exterior AM antenna can be used to improve reception; consult an antenna professional for more information.

SELECTING THE RADIO

Press the AM/FM key on the L73 front panel, the HTR L73's orange "TUNER" (the numeric 9 key), or the yellow "AM" and "FM" keys to select the receiver's radio mode. Each subsequent press of either key will toggle the unit between its FM and AM bands.

TUNING STATIONS

Press TUNE ◀/▶ on the front panel momentarily to step up or down between FM or AM frequencies. Press and hold TUNE ◀/▶ for more than 2 seconds to search up or down; the L73's tuner will stop at the next sufficiently strong signal it encounters. See "Front Panel," above. Pressing the TUNE ◀/▶ keys momentarily during the search process will stop the search.

After first pressing the yellow "TUNER" mode-select key on the HTR L73 to set the remote to control radio functions, press "TUNE DOWN" or "TUNE UP" on the HTR L73 (yellow lettering); press momentarily to perform slow manual search, hold in to automatically search (see above).

SETTING RADIO PRESETS

The L73 can store as many as 60 of your favourite radio stations for immediate recall; 30 FM stations and 30 AM. To store a radio preset, first tune the desired frequency (see above), then press the front panel MEMORY key. Press the PRESET ◀/▶ key to select the preset number to be assigned. Then press the MEMORY key once again.

NOTE

- *The Radio Presets must be stored from the front panel; this setup function is not accessible from the HTR L73 remote.*

SELECTING RADIO PRESETS

Press PRESET ▲/▼ on the front panel to step up or down between presets; press and hold PRESET ▲/▼ to "scroll" continuously up or down. The HTR L73 remote's "PRESET ▲/▼" keys work similarly.

CHOOSING THE FM MUTE / MODE

The front-panel FM MUTE/Mode key is a dual-purpose control. First, it "toggles" the L73 between stereo mute and unmuted mono reception (assuming that a multiplex-stereo station of sufficient strength is tuned). FM Mute eliminates noise from "empty" FM frequencies but also mutes very weak or distant stations. Toggling off the FM Mute will result in reduced noise if the FM station signal level is less than the FM Stereo threshold (since mono FM is inherently less noise-prone), though at the sacrifice of the stereo effect.

NOTE

Toggling between FM Mute on or off also defeats the L73's FM muting circuit. If you wish to listen to a particularly weak or distant broadcast, toggle off the FM Mute and tune it manually.

ABOUT RDS

The Radio Data System (RDS) permits compatible FM receivers to display text determined by the broadcaster. The L73 supports two RDS modes, station-name (PS mode) and radio-text (RT mode). However, not every FM station incorporates RDS in its broadcast signal; in most areas you will find from one to several RDS-enabled stations, but it is by no means impossible that your favourite stations will not be broadcasting RDS data.

VIEWING RDS TEXT

When an RDS-enabled FM broadcast is tuned, after a brief delay the "RDS" symbol will light in the L73's front-panel readout and the readout's character section will show its station-name (PS) text: "ROCK101," for example. Press the front-panel DISPLAY key to toggle the readout between this and the station's radio-text (RT) readout, if any, which might scroll song- or artist-name, or any other text of the station's choosing.

ABOUT THE L73'S SURROUND MODES

The L73 receiver offers nine distinct SURROUND MODEs, tailored for different types of recordings or program material. The table below lists which modes are available to what input signals.

With a two-channel (STEREO) source the following SURROUND MODEs can be selected:

- Dolby PRO LOGIC II MOVIE
- Dolby PRO LOGIC II MUSIC
- Dolby PRO LOGIC II EMULATION

Two-channel recordings, whether stereo or surround-encoded, are reproduced with ProLogic II surround processing, yielding output to left-, centre-, and right-front channels, discrete left/right surround channels, and subwoofer (assuming these are present in the current <SPEAKER SETTINGS>).

NOTE

ProLogic II is a more recent evolution of the original Dolby ProLogic surround processing that yields more stable imaging and full bandwidth sound to the rear channels in Movie mode, offering sound that is more similar to Dolby Digital decoding.

The L73 provides three Pro Logic II variations: MOVIES, MUSIC and EMULATION. See "Adjusting SURROUND MODEs".

EARS

Two-channel recordings, whether stereo or surround-encoded, are reproduced with proprietary NAD surround processing with signals output to the left, centre-, and right-front channels and discrete left/right surround channels, plus subwoofer (assuming these are present in the current <SPEAKER SETTINGS>). EARS extracts the natural ambience present in nearly all well produced stereo recordings. It does not synthesize any ambience or other sonic elements and thus remains truer to the sound of the original musical performance than most other music-surround options.

Select EARS for listening to stereo music recordings and broadcasts. EARS produces a subtle but highly natural and believable ambience from nearly all "natural-acoustic" stereo recordings; typically, these include classical, jazz, and folk genres as well as numerous examples from others. It's virtues include a realistic, stable "front-stage" sonic imaging and spacious but unexaggerated ambient "virtual acoustics" that remain faithful to the original recording.

ENHANCED STEREO

All recordings reproduced in stereo (Downmix, from Dolby Digital/DTS multichannel sources) are reproduced via the maximum speaker complement configured in the current <SPEAKER SETTINGS>. Enhanced-Stereo can be useful for maximum volume from all channels, or for multi-speaker background music (cocktail party) listening.

STEREO

All recordings reproduced in stereo (Stereo, or Downmix, from Dolby Digital/DTS multichannel sources) are reproduced via the front speakers only (plus subwoofer, if any). Stereo can prove useful in certain late-night or very low-volume listening situations.

The following Surround Sound Modes require a specially encoded signal that must be present in digital format to be decoded by the L73. These modes are automatically switched on when the appropriate data stream is detected. The desired data stream must sometimes be selected in the setup menu of the source media.

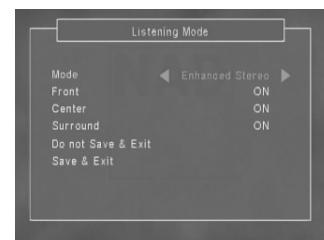

DOLBY DIGITAL / DTS

Digital recordings in Dolby Digital or DTS formats are reproduced via the channels employed in the original recording (up to the maximum channels present in the current <SPEAKER SETTINGS> setup).

NOTE

- *The DVD player must be sending a Dolby Digital or DTS bit-stream from its digital output. The DVD includes its own setup menu that (among other things) lets you select the default bit-stream format, and includes an "Auto" setting that directs the player to choose the Dolby Digital/DTS signal whenever these are available. In a few cases, you may have to set the player's bit-stream manually to "DOLBY DIGITAL: ON". In the case of DVDs that carry both Dolby Digital and DTS, you will select one or the other from the disc's (not the player's) main menu.*
- *While most Dolby Digital recordings are 5.1-channel surround productions, older examples may be multichannel, 2-channel, or even monaural; the L73 will automatically reproduce the Dolby Digital signal with the maximum number of channels available.*

The table below indicates which SURROUND MODEs are available with the two types of audio signal sources: digital- or analog-input 2-channel (whether the actual signal is monaural, stereo or surround-encoded), and digital-multichannel (Dolby Digital or DTS). Where a SURROUND MODE is not available to a given signal source, it will not appear in the <LISTENING MODE> selection rotation.

2-ch analog or PCM	Multi-ch. (DD/DTS)
Stereo	Downmix
EARS	—
—	Dolby Digital or DTS
Dolby Pro Logic II Music	—
Dolby Pro logic II Movie	—
Dolby Pro logic Emulation	—
Enhanced Stereo	—

SELECTING SURROUND MODES

Keying the HTR L73 remote's "SURR MODE" button steps through each of the L73's SURROUND MODEs available to the current input signal. It also momentarily displays the SURROUND MODE in the OSD.

NOTE

Changing the type of input signal may automatically change the SURROUND MODE: If the new signal is a Dolby Digital or DTS recording, it will automatically invoke its native mode. The reverse is also true if Dolby Digital or DTS was previously selected.

DOLBY VIRTUAL SPEAKER AND HEADPHONE

DOLBY® VIRTUAL SPEAKER

Dolby Virtual Speaker technology creates a highly compelling 5.1-channel listening experience from as few as two speakers, making it an ideal entertainment solution for locations where space for multiple-speaker setups is limited.

Dolby Virtual Speaker models the sound of a playback system into two different listening environments, based on acoustic measurements of real rooms:

DVS REFERENCE is a small, well-damped room appropriate for both movies and music-only recordings.

DVS WIDE is a larger room, more like a concert hall or movie theatre.

DOLBY® HEADPHONE

Dolby Headphone technology, compatible with any pair of conventional headphones, accurately simulates the experience of hearing a 5.1-channel speaker system properly set up in a listening room, minus the annoying "listener fatigue" effect that plagues other headphone-based virtual surround sound offerings. Dolby Headphone technology is ideal for private playback of multi-channel entertainment without disturbing others nearby.

Dolby Headphone models the sound of a playback system into three different listening environments, based on acoustic measurements of real rooms:

DH1 is a small, well-damped room appropriate for both movies and music-only recordings. This decoding process is known as the Dolby Headphone "Reference Room"

DH2 is a more acoustically live room suited to music listening, but also great for movies.

DH3 is a larger room, more like a concert hall or movie theatre.

ADJUSTING SURROUND MODES

Use the HTR L73 remote's "Surr. Mode" key, or the front panel SURROUND MODE key, to select the SURROUND MODE you wish to display and listen to; this will display on the L73's VFL Display. One can also select variations using the HTR L73 ◀/▶ cursor keys on the <SURROUND:> line of the OSD. Use the HTR L73's ▲/▼ and ◀/▶ cursor keys to navigate among and modify that mode's adjustable parameters (if any).

NOTE

SURROUND MODE parameter changes are not maintained when you change SURROUND MODEs.

DOLBY PRO LOGIC II (PLII)

PLII MOVIE is optimised for film soundtracks.

PLII MUSIC for music recordings.

PLII EMULATION for decoding original Dolby Surround sound film and music recordings.

DELAY TIME

SURRound (0 to 15 mS for PLII Music, 10 mS for PLII Movie and Emulation): Adjusts front-rear emphasis of the surround effect independently from the relative channel levels.

DTS**DELAY TIME**

CENTER (0 to 5 mS): Adjusts centre-front emphasis of the centre channel such as vocals, independently from the relative channel levels.

SURRound (0 to 15 mS): Adjusts front-rear emphasis of the surround effect independently from the relative channel levels.

DOLBY DIGITAL**DELAY TIME**

CENTER (0 to 5 mS): Adjusts centre-front emphasis of the centre channel such as vocals, independently from the relative channel levels.

SURRound (0 to 15 mS): Adjusts front-rear emphasis of the surround effect independently from the relative channel levels.

NIGHT-M (On or Off): Adjusts the dynamic range.

STEREO

No Delay

ENHANCED STEREO / EARS**DELAY TIME**

SURRound (0 to 15 mS): Adjusts front-rear emphasis of the surround effect independently from the relative channel levels.

ADJUSTING LEVEL TRIM "ON THE FLY"

You can make changes to the relative levels of centre, surround, and subwoofer outputs. This may prove useful in a number of circumstances; for example, to increase (or tone down) a film's dialog level by raising (lowering) the centre channel, or to reduce excessive deep bass (or enhance deep bass) by lowering (raising) the subwoofer level without having to go into the LEVEL TRIM OSD menu.

TO ADJUST LEVEL TRIM

Use the HTR L73 remote's "SURR", "CENTER", and "SUB" ▲/▼ keys for direct-access level adjustment of these channels, over a range of ± 10 dB. You can also adjust all channel levels using the front panel's navigation keys (see "Front Panel," above), or via the <LEVEL TRIM> line of the OSD's <MAIN MENU> screen.

NOTE

- *The surround channels (if any) adjust in tandem. Channel Level changes made via the HTR L73 are retained even if you cycle the receiver through standby.*
- *Level settings are added/subtracted to the setup levels established by the L73 level-calibration routine, invoked by the HTR L73 "Test" key.*

ADJUSTING THE TONE CONTROLS

The L73 bass and treble controls are adjusted using the front panel's TONE button in conjunction with the VOLUME knob; see "Front Panel," above.

NOTE

Bass/treble settings affect only the front left/right channels, and are active in all SURROUND MODES.

ABOUT THE 12 V TRIGGER OUT

The L73's rear-panel 12 V TRIGGER OUT is a convenient method of controlling on and off any auxiliary equipment that is connected to or is used in conjunction with the L73, when the L73 is turned on or to standby via remote or the front panel power button.

12 V TRIGGER OUT

The L73's rear-panel 12 V TRIGGER OUT is a female miniature 3.5 mm stereotype jack that will produce +12 V DC at approximately 50 mA. Use a 3.5 mm stereotype miniature phone plug with the centre pin + 12 V and the first band the ground. We recommend that you use a good quality cable with shield when attaching the 3.5 mm stereotype plug so as to prevent false triggering of the auxiliary equipment due to electro-magnetic interference from nearby electronic equipment. See your NAD audio specialist for more information.

SPECIFICATIONS

- Controls up to 8 devices
- 44 function keys
- Learns up to 352 commands
- Records up to 44 macros with a maximum of 64 commands each
- Configurable punch-through
- Key illumination with programmable timeout
- Upgradable
- Contains pre-programmed library of NAD remote codes for the L73.

The NAD HTR L73 is ready to operate the L73 receiver right out of the box, but it is really eight remotes in one. Each of the 8 Device Selector keys at the top of the handset can call up a new “page” of remote-control codes to be transmitted by the remaining 44 keys. You may “teach” codes from any infrared-remote-controlled component, regardless of brand, to any or all of these. Obviously, the most logical system is that you teach the codes from your DVD player to the “DVD” Device Selector “page,” your television’s codes to the “TV” “page,” and so on, but there is no required scheme: You may load any commands to any key on any page (see “Learning Codes From Other Remotes,” below).

The HTR L73 is already preprogrammed with a full complement of commands for the L73 receiver on its “AMP,” “TUNER” and “DVD” Device Selector page, and as well as with library commands to operate most NAD-brand DVD, CD, or TAPE components on the corresponding Device Selector “pages.” These default commands are permanent: Even if you teach the HTR L73 new commands to take their place, the underlying library commands remain in place and can easily be recalled should you add an NAD component to your system later (see “Delete Mode,” below).

NOTE

For use with the L73, it should not be necessary to re-program any keys on the HTR L73 “AMP” and “DVD” page. However, in order for the HTR L73 to control your specific NAD-brand components you may need to load one or more different code-libraries; see “Loading Code Libraries,” below.

CONTROLLING THE L73

The HTR L73 is divided into two main sections. Eight Device Selector keys at the top-“AMP,” “DVD,” “TV,” and so on-set the handset’s remaining keys to a “page” of commands to control a particular component. A Device Select key determines only what component the HTR L73 will command; it does not perform any function on the receiver. All of the remaining keys are function keys that can “learn” control codes from virtually any infrared remote controller, allowing you to teach the codes of your equipment, regardless of brand, to the HTR L73.

However, the HTR L73 is already preprogrammed to operate the L73. All of the function keys on the “AMP,” “TUNER” and “DVD” Device Selector “page” perform L73 functions. (The HTR L73 can also command many other NAD components, from its “CD” and “TAPE” pages.)

It is important to note that certain HTR L73 keys perform different functions depending on the selected Device Selector “page.” The colour of the Device Selector key-labelling corresponds to the labelling of the function keys. Most centrally, the orange “AMP” Device Selector “page” corresponds to the orange input-select labelling adjacent to the numeric keys: When the HTR L73’s “AMP” Device Selector page is active, these keys select the receiver inputs. Similarly, the red “DVD” Device Selector “page” corresponds to several red labels, the green “TV” page to green labels, and so on.

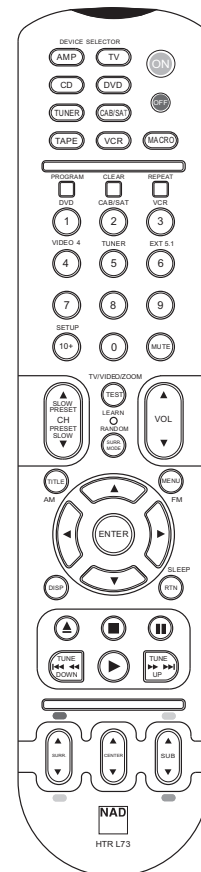

ENGLISH

LEARNING CODES FROM OTHER REMOTES

Begin by positioning the HTR L73 "nose-to-nose" with the source remote so the two devices' infrared windows are about 2 inches apart.

- Enter Learning Mode: On the HTR L73, simultaneously press-and-hold for 3 seconds both a Device Selector key and the ▲ "OPEN/CLOSE" key (just below the "DISP" key), until the Learn LED at the centre of the HTR L73 turns steady green.
- Press the HTR L73's function key you wish to teach a command; the Learn LED will turn amber.
- Press-and-hold the function key on the source remote: The HTR L73's Learn LED will flicker amber for a second or two, then turn solid green. The command is learned.
- Press the HTR L73's Device Selector key again to exit the learning mode.

If the Learn LED does not flicker amber you may need to vary the distance between the remotes. If the Learn LED turns red rather than green, that particular command of that source remote command could not be learned.

CANCEL OPERATION

You can cancel configuring a key, by pressing the active Device Selector key before the learn process is complete; the Learn LED will turn red.

Example: Learning "VCR Pause":

Position the HTR L73 and your VCR player's remote as described above.

- On the HTR L73, simultaneously press-and-hold "VCR" and ▲ ; the Learn LED turns steady green.
- Press the HTR L73's || (pause) key; the Learn LED turns amber.
- Press-and-hold the VCR player's remote's pause key; the HTR L73's Learn LED flickers amber and then turns solid green. The command is learned.
- Press "VCR" again to exit the learning mode.

PUNCH-THROUGH

The HTR L73's "punch-through" function allows you to retain a function key from one Device Select "page" on another, so that, for example, the AMP "SURR MODE" function might still control the L73 when the DVD Device Selector page is active

NOTE

The HTR L73's "VOL" and "MUTE" keys are pre-programmed as "punched-through" for all Device Select pages: "VOL" will operate the L73's master-volume regardless of the currently selected device. The "SURR," "CENTER," and "SUB" Channel Volume controls similarly are pre-programmed as punched-through.

To set a punch through, after entering the Learning Mode, and pressing the desired key to be punched-through, simply press the device key twice of the device to punch through to. The status LED will turn green; press the Device Selector key again to exit Learning Mode.



Example: Punch-through the from the DVD "page" to the AMP "SURR MODE" key:

- On the HTR L73, simultaneously press-and-hold "DVD" and ▲ (OPEN/CLOSE); the Learn LED turns steady green.
- Press "SURR MODE"; the Learn LED turns amber.
- Press "AMP" twice; the Learn LED turns green.
- Press "DVD" again to exit the learning mode.

COPY A COMMAND FROM ANOTHER KEY

You may copy a command from any HTR L73 key to any other. To copy a key function, after entering the Learning Mode, and pressing the desired key to be copied to, simply press the device key from which you wish to copy, having first pressed its Device Selector key if it resides on another "page." The status LED will turn green; press the Device Selector key again to exit Learning Mode.

Example: Copy the Pause command from the DVD page to the AMP  key:

- On the HTR L73, simultaneously press-and-hold "AMP" and  (OPEN/CLOSE); the Learn LED turns steady green.
- Press  (pause); the Learn LED turns amber.
- Press "CD"; press  (pause); the Learn LED turns green.
- Press "AMP" again to exit the learning mode.

NOTE

The copy and punch-through functions are similar. However, if you copy a command and then subsequently delete, or over-write the original (source-key) command, the copied-to key's command remains unchanged. If you punch-through to a command and then delete or over-write the original key, the punched-through functions also change accordingly.

MACRO COMMANDS

A "macro" command is a series of two or more remote codes issued automatically from a single keypress. You might use a macro to automate a simple command sequence, such as, "Turn on the DVD player and then press 'play.'" Or you might compose an elaborate macro to power up an entire system, select a source, choose a SURROUND MODE, and begin playback-again, all from a single keypress. The HTR L73 can store one macro on each of its function keys (these exclude the Device Selector keys).

NOTE

Macros are independent of the currently selected device.

RECORDING MACROS

To record a macro, simultaneously press-and-hold for 3 seconds both the "MACRO" key and the HTR L73 function key to which you wish to assign the macro, until the status LED turns green. The macro button will also light up. Press the sequence of function keys to be recorded into the macro, being sure to first press the requisite Device Selector key for each function (you may switch devices while recording the macro as many times as necessary), allowing you to create macro containing commands from more than one Device Selector "page." When you have finished entering the desired command sequence, press "MACRO" again to store the macro; the Learn LED and "MACRO" key illumination will turn off.

NOTE

Each macro can store a maximum of 64 command steps. If you exceed this number, the macro will be stored automatically after the 64th command is added.

Example: Record a Macro to the "0" key to Turn on the L73, Select the DVD Input, and Commence Playback:

- On the HTR L73, simultaneously press-and-hold "MACRO" and "0" (numeric zero); the Learn LED turns steady green.
- Press "AMP"; press "ON"; press "1" (orange "DVD"); press "DVD"; press "play" (the Learn LED blinks as each step is added).
- Press "MACRO" again to exit the macro-record mode.

To clear a macro, perform the above steps without entering any functions.

EXECUTING MACROS

To execute a macro, press and release "MACRO"; its key illumination lights for 5 seconds. While it remains lit, press an HTR L73 key to which a macro has previously been stored. The corresponding macro will run; as each step executes, its "parent" Device Selector's key flashes lights briefly; when execution is finished, the "MACRO" key illumination goes out. Pressing any other HTR L73 key while a macro is executing will abort the macro. Remember that you must hold the HTR L73 so that its infrared emitter can activate the target components.

NOTE

When a macro executes, a 1 second delay is automatically inserted between its commands. If you need more than a 1 second delay between particular commands—for example, to permit a component to power up completely—you can record "empty" steps into the macro by changing Device Selector "pages" without entering actual command functions.

KEY-ILLUMINATION TIMEOUT

The HTR L73's key-illumination can be set to remain lit for 0-9 seconds. The default value is 5 seconds.

To set the illumination timeout, simultaneously press-and-hold for 3 seconds both the HTR L73's "DISP" and the "0-9" key, with the digit corresponding to the desired timeout duration; the Learn LED will flash twice to confirm the new setting. When set to zero, the illumination will not turn on at all.

NOTE

Key illumination is the biggest drain on the HTR L73's batteries. A short key-illumination timeout will extend battery life appreciably; turning it off altogether (set it to 0 seconds) will lengthen it still further.

FACTORY RESET

The HTR L73 can be reset to its factory state, deleting all learned commands, copied and punched-through keys, macros, and other setup information, reverting all keys to their pre-programmed library commands. To perform a factory reset simultaneously press-and-hold for 10 seconds the HTR L73's "ON" and "RTN" keys; the Learn LED will start to flash green. Release "ON" and "RTN" before the second flash is complete; the Learn LED will turn red, indicate the remote has been reset.

NOTE

You must release "ON" and "RTN" before the second flash goes out, otherwise the unit will not reset; should this occur, repeat the full procedure.

DELETE MODE

The HTR L73 can store learned, copied, and "default library" commands on any single key. (The default library commands are the pre-programmed NAD codes, such as the native L73 commands on the "AMP" "page.") You can delete commands by layers back "down" to the default library command on any key, removing learned commands, punched-through functions, and copied keys.

NOTE

The default library commands cannot be deleted, so you need not worry that using Delete Mode might cause irreparable changes.

To enter Delete Mode, simultaneously press-and-hold for 3 seconds both the desired key's Device Selector key and the "RTN" key, until the Learn LED turns green. Press the function key whose command you wish to delete; the Learn LED flashes; the number of times indicates which type of function has become active—see the table below. Press the active Device Selector key again to exit Delete Mode.

NOTE

You may delete multiple function-key commands on the same Device Selector "page," but to delete from more than one Device Selector page you must exit Delete Mode and then re-enter it on the required page.

Flashes	Command Type
1	Default Library Command
2	Copied Library Command
3	Learned Command

LOADING CODE-LIBRARIES

The HTR L73 can store a different library of default NAD codes for each of its Device Selector “pages.” If the original default library does not control your NAD CD player, tape deck, DVD player, or other component, follow the procedure below to change the code-library.

Begin by ensuring that the component you wish the HTR L73 to control is plugged in and powered-up (“on,” not merely in standby). To enter the HTR L73’s Library Mode, simultaneously press-and-hold for 3 seconds both the desired Device Selector key and the “PROGRAM” key, until the Learn LED turns green. While keeping the HTR L73 pointed toward the component, enter the first appropriate three-digit code-library number from the table below. If the component turns off, press “ENTER” to accept that code-library number and exit the Library Mode. If the component does not turn off, enter the next three-digit code-library number from the table. When you enter the correct number the component will turn off; press “ENTER” to accept that code-library number and exit the Library Mode.

NAD-brand component	HTR L73 code-library numbers
CD Player (new)	200
CD Player (old)	201
DVD T562	600
DVD T550, L55	601
DVD T531, T571	602
DVD T512, T532, T572	602

SEARCH MODE

If none of the codes from the table turn off the component, and if you are quite sure you have followed the above procedure completely and carefully, you may want to try the “search” method as follows:

Enter Library Mode by simultaneously pressing-and-holding for 3 seconds both the desired Device Selector key and the “PROGRAM” key, until the Learn LED turns green. Now press-and-hold the HTR L73’s ▲ or ▼ key; the remote will step through all the available codes at a rate of approximately 1 per second. When the component turns off, immediately release the cursor key; press “ENTER” to accept that code-library and exit the Library Mode. Try a few commands; should you prove to have stepped past the needed code-library, re-enter the Library Mode and use the cursor key to step back to it.

NOTE

It is possible that search mode will find code-libraries that operate, at least partially, some other-brand (non-NAD) components. You may certainly exploit such capabilities as you find them. However, since we can only ensure the completeness or accuracy of NAD code-libraries, we cannot support the HTR L73’s operation with other-brand components.

Operation

USING THE HTR L73 REMOTE CONTROL

CHECKING CODE-LIBRARY NUMBER

You can check the current code-library on any Device Selector key as follows. Enter Library Mode by simultaneously pressing-and-holding for 3 seconds both the desired component's Device Selector key and the "PROGRAM" key, until the Learn LED turns green. Press the "DISP" key; the HTR L73 indicates the current code-library by flashing its "TAPE", "VCR", and "MACRO" keys. For example, to indicate code-library #501 the HTR L73 will flash "TAPE" 5 times, pause, and then flash "MACRO" once. You might wish to make a note of your components' code-library numbers.

SUMMARY OF HTR L73 MODES

Mode	Keys To Press (for 3 seconds)
Learn/Copy/Punch Through	Device Key + OPEN/CLOSE Key
Delete Mode	Device Key + Return Key
Macro Record	Macro Key + Function Key
Library Mode	Device Key + Program Key
Back Light Timeout	Display Key + Digit Key
Factory Reset	(see "Factory Reset," above)

CONDITION	POSSIBLE CAUSE(S)	POSSIBLE SOLUTIONS(S)
NO SOUND FROM ALL CHANNELS	<ul style="list-style-type: none"> AC power unplugged Power not switched on Outlet is unpowered Tape Monitor is engaged 	<ul style="list-style-type: none"> Check AC cable, connection, and outlet Disengage Tape Monitor
NO SOUND FROM SOME CHANNELS	<ul style="list-style-type: none"> Faulty/missing cables; <SPEAKER CONFIGURATION> channel(s) set to "None" Power-amp or speaker-connections faulty 	<ul style="list-style-type: none"> Check cables Check <SPEAKER CONFIGURATION> menu Check power amp, cabling, and speakers
NO SOUND FROM SURROUND CHANNELS	<ul style="list-style-type: none"> No SURROUND MODE is engaged Surround-channels set to "None" on <SPEAKER CONFIGURATION> menu Surround-channels level set too low on <LEVEL TRIM> menu 	<ul style="list-style-type: none"> Select appropriate SURROUND MODE Correct <SPEAKER CONFIGURATION> or <LEVEL TRIM> settings
NO SOUND FROM SUBWOOFER	<ul style="list-style-type: none"> Subwoofer is off, unpowered, or improperly connected Subwoofer set to "OFF" on <SPEAKER CONFIGURATION> menu Sub level set too low on <LEVEL TRIM> menu 	<ul style="list-style-type: none"> Power-up subwoofer, check sub's AC outlet, or check connections Correct <SPEAKER CONFIGURATION> or <Levels setup> settings
NO SOUND FROM CENTRE CHANNEL	<ul style="list-style-type: none"> Source is a 2/0 (etc.) Dolby Digital or DTS recording without centre channel Centre set to "OFF" on <SPEAKER CONFIGURATION> menu Centre level set too low on <LEVEL TRIM> menu 	<ul style="list-style-type: none"> Play a known 5.1-channel recording or select Dolby Pro Logic or Mono mode Correct <SPEAKER CONFIGURATION> or <LEVEL TRIM> settings
NO DOLBY DIGITAL/DTS	<ul style="list-style-type: none"> Source's digital output is not connected to a L73 digital input; source component not configured for multichannel digital output 	<ul style="list-style-type: none"> Check connections; check source component setup
L73 DOES NOT RESPOND TO HTR L73 REMOTE	<ul style="list-style-type: none"> Batteries are flat or incorrectly inserted IR transmitter window on remote, or IR receiver window on L73 is obstructed L73 front panel is in very bright sunlight or ambient light 	<ul style="list-style-type: none"> Check batteries Check IR windows and ensure clear line-of-sight from remote to L73 Reduce sunlight/room lighting
L73 DOES NOT RESPOND TO FRONT-PANEL COMMANDS	<ul style="list-style-type: none"> Microprocessor error L73 may have over-heated 	<ul style="list-style-type: none"> Power-down the L73 via the front-panel Power key and unplug it from the AC outlet Wait five minutes, re-connect and power up
THE POWER IS ON, BUT THE DVD PLAYER DOES NOT WORK	<ul style="list-style-type: none"> No disc is inserted. 	<ul style="list-style-type: none"> Insert a disc (Check that the DVD or, audio CD indicator in the display is lit)
NO PICTURE	<ul style="list-style-type: none"> The TV is not set to receive DVD signal The video cable is not connected securely The connected TV power is turned off 	<ul style="list-style-type: none"> Select the appropriate video input mode on the TV so that the picture from the DVD player appears on the TV screen output. Connect the video cable into the jacks securely. Power on the TV
NO SOUND	<ul style="list-style-type: none"> The Digital Audio Output is set to the wrong position 	<ul style="list-style-type: none"> Set the Digital Audio Output to the correct position
THE PLAYBACK PICTURE IS POOR	<ul style="list-style-type: none"> The disc is dirty 	<ul style="list-style-type: none"> Clean the disc
THE DVD PLAYER DOES NOT START PLAYBACK	<ul style="list-style-type: none"> No disc is inserted An unplayable disc is inserted The disc is placed upside down. The disc is not placed within the guide A menu is on the TV screen The disc is dirty 	<ul style="list-style-type: none"> Insert a disc (Check that the DVD, or audio CD indicator in the DVD display is lit) Insert a playable disc (Check the disc type colour system and Regional code) Place the disc with the playback side down Place the disc on the disc tray correctly inside the guide Press SETUP to turn off the menu screen Clean the disc
PARENTAL CONTROL CANNOT BE CHANGED	<ul style="list-style-type: none"> The password entered was wrong. Password was forgotten. 	<ul style="list-style-type: none"> Enter the correct password. Set the L73 to factory default settings. <ol style="list-style-type: none"> Place the L73 into FM mode. Press quickly the three front panel buttons; "PLAY/PAUSE" then "STOP" then "DISPLAY", holding the "DISPLAY" button for more than 7 seconds. The L73 will switch itself off then back on to DVD mode.

NOTE

Default password is 1234.

DVD SECTION

Signal system	PAL/NTSC/AUTO)
Laser	Semiconductor laser, Wavelength 650 nm
Frequency range (audio)	4 Hz to 20 kHz
Signal-to-noise ratio (audio)	More than 100 dB (EIAJ)
Dynamic range (audio)	More than 95 dB (EIAJ)
Harmonic distortion (audio)	0.008 %
JPEG Baseline	< 5120 x 3840 pixels
JPEG Progressive	< 2048 x 1536 pixels

AMPLIFIER SECTION

Power output Stereo Mode ¹	2 x 60W
IHF dynamic power; 8 ohms	2 x 82W
Power output Surround Mode	5 x 45W
Total harmonic distortion at rated power	0.08%
IM distortion at rated power	0.08%
Damping factor 8 ohms	> 60
Input sensitivity and impedance	200mV / 50k ohms
Frequency response	20 to 20,000 Hz ±0.5 dB
Signal/noise ratio ²	>99 dB
Signal/noise ratio ³	>85 dB

Remote control	HTR L73
----------------	---------

TUNER SECTION

Input sensitivity	Mono	16.1 dBf
	50dB Stereo	36.1 dBf
Harmonic Distortion	FM Mono	0.2%
	FM Stereo	0.5%
Signal / noise	Mono	69 dB
	Stereo	64 dB
Stereo separation at 1 kHz		40 dB
Frequency Response; ± 1.5 dB		30 Hz - 15 kHz

PHYSICAL SPECIFICATIONS

Dimensions (W x H x D)	17 1/8 x 5 1/4 x 14 3/4" (435 x 133 x 375mm)
Net Weight	26 lbs (11.8 kg)
Shipping Weight	32 lbs (14.5 kg)

¹ 8 ohms within rated distortion
² Ref rated power / 8 ohms (A-WTD)
³ Ref 1W / 8 ohms (A-WTD)

Specifications are subject to change without notice. For updated documentation and features please log onto www.nadelectronics.com for the latest information about your L73.



www.NADelectronics.com

**©2005 NAD ELECTRONICS INTERNATIONAL
A DIVISION OF LENBROOK INDUSTRIES LIMITED**

All rights reserved. No part of this publication may be reproduced, stored or transmitted in any form without the written permission of NAD Electronics International

L73 Manual 01/05 Korea