



T 748

AV Surround Sound Receiver

ENGLISH



Owner's Manual

IMPORTANT SAFETY INSTRUCTIONS



THE LIGHTNING FLASH WITH ARROWHEAD SYMBOL, WITHIN AN EQUILATERAL TRIANGLE, IS INTENDED TO ALERT THE USER TO THE PRESENCE OF UNINSULATED "DANGEROUS VOLTAGE" WITHIN THE PRODUCT'S ENCLOSURE THAT MAYBE OF SUFFICIENT MAGNITUDE TO CONSTITUTE A RISK OF ELECTRIC SHOCK TO PERSONS.



THE EXCLAMATION POINT WITHIN AN EQUILATERAL TRIANGLE IS INTENDED TO ALERT THE USER TO THE PRESENCE OF IMPORTANT OPERATING AND MAINTENANCE (SERVICING) INSTRUCTIONS IN THE LITERATURE ACCOMPANYING THE APPLIANCE.

CAUTION

RISK OF ELECTRIC SHOCK
DO NOT OPEN

CAUTION : TO REDUCE THE RISK OF ELECTRIC SHOCK, DO NOT REMOVE COVER (OR BACK). NO USER-SERVICEABLE PARTS INSIDE REFER SERVICING TO QUALIFIED SERVICE PERSONNEL.

WARNING

TO REDUCE THE RISK OF FIRE OR ELECTRIC SHOCK, DO NOT EXPOSE THIS PRODUCT TO RAIN OR MOISTURE.

SAVE THESE INSTRUCTIONS FOR LATER USE. FOLLOW ALL WARNINGS AND INSTRUCTIONS MARKED ON THE EQUIPMENT.

- 1 Read these instructions.
- 2 Keep these instructions.
- 3 Heed all warnings.
- 4 Follow all instructions.
- 5 Do not use this apparatus near water.
- 6 Clean only with a dry cloth.
- 7 Do not block any of the ventilation openings. Install in accordance with the manufacturer's instructions.
- 8 Do not install near any heat sources such as radiators, heat registers, stoves, or other apparatus (including amplifiers) that produce heat.
- 9 Do not defeat the safety purpose of the polarized or grounding type plug. A polarized plug has two blades with one wider than the other. A grounding type plug has two blades and a third grounding prong. The wide blade or the third prong is provided for your safety. When the provided plug does not fit into your outlet, consult an electrician for replacement of the obsolete outlet.
- 10 Protect the power cord from being walked on or pinched particularly at plugs, convenience receptacles, and the point where they exit from the apparatus.
- 11 Only use the attachments/accessories specified by the manufacturer.
- 12 Use only with a cart, stand, tripod, bracket, or table specified by the manufacturer, or sold with the apparatus. When a cart is used, use caution when moving the cart/apparatus combination to avoid injury from tip-over.
- 13 Unplug this apparatus during lightning storms or when unused for long periods of time.
- 14 Refer all servicing to qualified service personnel. Servicing is required when the apparatus has been damaged in any way, such as power supply cord or plug is damaged, liquid has been spilled or objects have fallen into the apparatus, the apparatus has been exposed to rain or moisture, does not operate normally, or has been dropped.

NOTE TO CATV SYSTEM INSTALLER

This reminder is provided to call the CATV system installer's attention to Section 820-40 of the NEC which provides guidelines for proper grounding and, in particular, specifies that the cable ground shall be connected to the grounding system of the building, as close to the point of cable entry as practical.

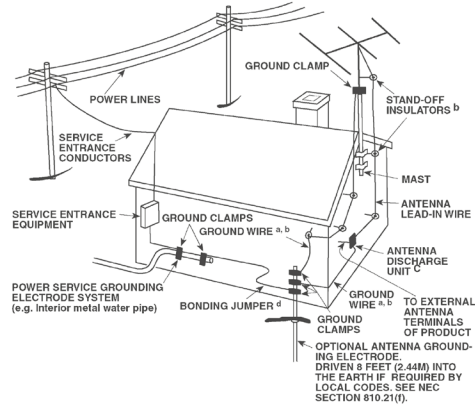

FCC NOTICE

This equipment has been tested and found to comply with the limits for a Class B digital device, pursuant to part 15 of the FCC Rules. These limits are designed to provide reasonable protection against harmful interference in a residential installation.

This equipment generates uses and can radiate radio frequency energy and if not installed and used in accordance with the instructions, may cause harmful interference to radio communications. However, there is no guarantee that interference will not occur in a particular installation. If this equipment does cause harmful interference to radio or television reception, which can be determined by turning the equipment off and on, the user is encouraged to try to correct the interference by one or more of the following measures

- Reorient or relocate the receiving antenna.
- Increase the separation between the equipment and receiver.
- Connect the equipment into an outlet on a circuit different from that to which the receiver is connected
- Consult the dealer or an experienced radio/TV technician for help.

WARNING!

The unit must not be exposed to dripping or splashing liquids, and liquid-filled objects such as vases or cups should not be placed on the unit.

CAUTION

Changes or modifications to this equipment not expressly approved by NAD Electronics for compliance could void the user's authority to operate this equipment.

CAUTION

These servicing instructions are for use by qualified service personnel only. To reduce the risk of electric shock, do not perform any servicing other than that contained in the operating instructions unless you are qualified to do so.

ATTENTION

Disconnect this apparatus from the AC mains completely by unplugging the power cord plug from the AC receptacle.

CAUTION REGARDING PLACEMENT

To maintain proper ventilation, be sure to leave a space around the unit (from the largest outer dimensions including projections) that is equal to or greater than shown below.

- Left and Right Panels:** 10 cm
- Rear Panel:** 10 cm
- Top Panel:** 20 cm



WARNING: DO NOT INGEST BATTERY, CHEMICAL BURN HAZARD

The remote control supplied with this product contains a coin/button cell battery. If the coin/button cell battery is swallowed, it can cause severe internal burns in just 2 hours and can lead to death.

Keep new and used batteries away from the children. If the battery compartment does not close securely, stop using the product and keep it away from children.

If you think batteries might have been swallowed or placed inside a part of the body, seek immediate medical attention.

NOTES ON ENVIRONMENTAL PROTECTION



At the end of its useful life, this product must not be disposed of with regular household waste but must be returned to a collection point for the recycling of electrical and electronic equipment. The symbol on the product, user's manual and packaging, point this out.

The materials can be reused in accordance with their markings. Through re-use, recycling of raw materials or other forms of recycling of old products, you are making an important contribution to the protection of our environment. Your local administrative office can advise you of the responsible waste disposal point.

INFORMATION ABOUT COLLECTION AND DISPOSAL OF WASTE BATTERIES (DIRECTIVE 2006/66/EC OF THE EUROPEAN PARLIAMENT AND THE COUNCIL OF EUROPEAN UNION) (FOR EUROPEAN CUSTOMERS ONLY)

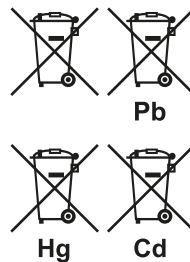

Batteries bearing any of these symbols indicate that they should be treated as "separate collection" and not as municipal waste. It is encouraged that necessary measures are implemented to maximize the separate collection of waste batteries and to minimize the disposal of batteries as mixed municipal waste.

End-users are exhorted not to dispose waste batteries as unsorted municipal waste. In order to achieve a high level of recycling waste batteries, discard waste batteries separately and properly through an accessible collection point in your vicinity. For more information about collection and recycling of waste batteries, please contact your local municipality, your waste disposal service or the point of sale where you purchased the items.

By ensuring compliance and conformance to proper disposal of waste batteries, potential hazardous effects on human health is prevented and the negative impact of batteries and waste batteries on the environment is minimized, thus contributing to the protection, preservation and quality improvement of the environment.

NOTE: THE T 748 IS NOT AN AUTO VOLTAGE UNIT. CONNECT ONLY TO THE PRESCRIBED AC OUTLET, I.E., 120V 60HZ OR 230V 50HZ.

RECORD YOUR MODEL NUMBER (NOW, WHILE YOU CAN SEE IT)

The model and serial number of your new T 748 are located on the back of the cabinet. For your future convenience, we suggest that you record these numbers here:

Model no:
 Serial no:

INTRODUCTION

TABLE OF CONTENTS

IMPORTANT SAFETY INSTRUCTIONS2

INTRODUCTION

GETTING STARTED	5
WHAT'S IN THE BOX	5
INITIAL SETUP	5
CHOOSING A LOCATION	5
DEFAULT SOURCE SETTINGS	5

IDENTIFICATION OF CONTROLS

FRONT PANEL	6
REAR PANEL	8
AVR 4 REMOTE CONTROL	10
USING THE AVR 4 REMOTE CONTROL	10
LIBRARY	12
USING THE ZR 7 REMOTE CONTROL	13

OPERATION

USING THE T 748 - MAIN MENU	14
ABOUT THE ON-SCREEN DISPLAY (OSD)	14
MAIN MENU	14
LISTENING MODE	14
ADJUSTING LISTENING MODES	15
DSP OPTION	16
TONE CONTROLS	16
ZONE 2 CONTROLS	16
USING THE T 748 - SETUP MENU	17
SETUP MENU	17
SOURCE SETUP	17
SOURCE SETUP (NORMAL)	17
SOURCE SETUP (TABLE)	18
iPod SETUP	18
SPEAKER SETUP	19
AUTO CALIBRATION	19
SPEAKER CONFIGURATION	20
SPEAKER LEVELS	20
SPEAKER DISTANCE	21
ADJUSTING THE VOLUME	21
AMPLIFIER SETUP	21
HDMI SETUP	21
LISTENING MODE SETUP	22
LISTENING MODES	22

DOLBY DIGITAL SURROUND MODES	22
DOLBY SETUP	23
DTS SETUP	24
DTS SURROUND MODES	24
ENHANCED STEREO	24
DISPLAY SETUP	25
AV PRESETS SETUP	25
AUTO POWER DOWN SETUP	28
LISTENING TO AM/FM RADIO	29
SELECTING A TUNER BAND	29
STORING PRESETS (AM/FM)	29
CHOOSING THE TUNER MODE	30
ABOUT USER NAMES	30
ABOUT RDS	30
LISTENING TO DAB RADIO	31
CONNECTING THE DAB MODULE	31
DAB OPERATION	31
SERVICE LIST	31
DAB TUNER MODE	32
LOCAL SCAN	32
STATION ORDER	32
DYNAMIC RANGE	32
MANUAL TUNE	32
PRUNE LIST	33
DAB RESET	33
SETTING DAB PRESETS	33
DELETING A DAB PRESET	33
INFORMATION SETTINGS	34

OPERATION

LISTENING TO YOUR iPod PLAYER	35
CONNECTING THE OPTIONAL NAD IPD AND	35
iPod PLAYER TO THE T 748	35
iPod MENU OPTIONS	35
CONTROL FEATURES	36
NAD IPD 2	36
TO VIEW VIDEOS OR PHOTOS LOADED IN YOUR iPod	36

REFERENCE

TROUBLESHOOTING	37
SPECIFICATIONS	38

THANK YOU FOR CHOOSING NAD.

The T 748 AV Surround Sound Receiver is a technologically advanced and highly capable product yet we have invested great effort in making it simple and easy to use. The T 748 delivers a range of genuinely useful options for surround sound and stereo listening alike, using powerful digital signal processing and superbly accurate digital-audio circuitry. However, we have also been careful to ensure that the T 748 is as musically transparent, faithful to every video detail and spatially accurate as possible, incorporating much of what we've learned from over three decades of experience designing audio, video and home-theater components. As with all our products, NAD's "Music First" design philosophy guided the T 748's design, such that it can confidently promise you both state-of-the-art surround home-theater and audiophile-quality music listening for years to come.

We encourage you to take a few minutes now to read right through this manual. Investing a little time here at the outset might save you a good deal of time later, and is by far the best way to ensure that you make the most of your investment in the T 748, and get the most from this powerful and flexible home-theater component.

One more thing: We urge you to register your T 748 ownership on the NAD Worldwide Web site:

<http://NADelectronics.com>

For warranty information contact your local distributor.

NAD SHALL NOT BE HELD LIABLE FOR ANY TECHNICAL OR USER INTERFACE DISCREPANCIES IN THIS MANUAL.

THE T 748 OWNER'S MANUAL MAY BE SUBJECT TO CHANGE WITHOUT PRIOR NOTICE. CHECK OUT THE NAD WEBSITE FOR THE LATEST VERSION OF THE T 748 OWNER'S MANUAL.

WHAT'S IN THE BOX

Packed with your T 748 you will find

- An AM loop antenna
- A FM ribbon-wire antenna with balun
- A detachable mains power cord
- Measurement microphone for auto calibration
- AVR 4 remote control with 2 AA batteries
- ZR 7 zone remote control with 3V CR2025 battery
- Owner's manual in CD-ROM

SAVE THE PACKAGING

Please save the box and all of the packaging in which your T 748 arrived. Should you move or otherwise need to transport your T 748, this is by far the safest container in which to do so. We've seen too many otherwise perfect components damaged in transit for lack of a proper shipping carton, so please: Save that box!

INITIAL SETUP

Before you make the first connection to your T 748, you should have the arrangement of your listening room/home theater components and furniture mapped out, at least initially. Unfortunately, a discussion of the vital questions of loudspeaker placement and listening/viewing positions is beyond our scope here.

CHOOSING A LOCATION

Choose a location that is well ventilated (with at least several inches to both sides and behind), and that will provide a clear line of sight, within 25 feet/8 meters, between the T 748's front panel and your primary listening/viewing position - this will ensure reliable infrared remote control communications. The T 748 generates a modest amount of heat, but nothing that should trouble adjacent components. It is especially important that sufficient ventilation be provided.

DEFAULT SOURCE SETTINGS

The following table lists the default SOURCE settings. Note that the Audio input settings show both digital and analog audio input. Digital input will always take precedence over analog audio input even if both are present.

Source	Audio Input	Video Input
Source 1	HDMI 1/ Audio 1	HDMI 1
Source 2	Optical 2/ Audio 2	Component Video 1
Source 3	Coaxial 1/Audio 3	Video 1
Source 4	Coaxial 2/Audio 3	Video 2
iPod	Audio 2	S-Video
Front	Optical Front Input/ Audio Front Input	S-Video Front Input
Media Player	Audio Front Input	
Tuner		

For Video output, select the highest quality video format available on your TV/Monitor and utilize this for your Monitor OUT connection from the T 748 to the TV/Monitor. For T 748, this should be HDMI with the other choice being Composite video output.

To modify the above default settings and for a better understanding of source setting and combinations, please refer to the item about "SOURCE SETUP" in the "USING THE T 748 - SETUP MENU" segment of the "OPERATION" section.

IDENTIFICATION OF CONTROLS

FRONT PANEL

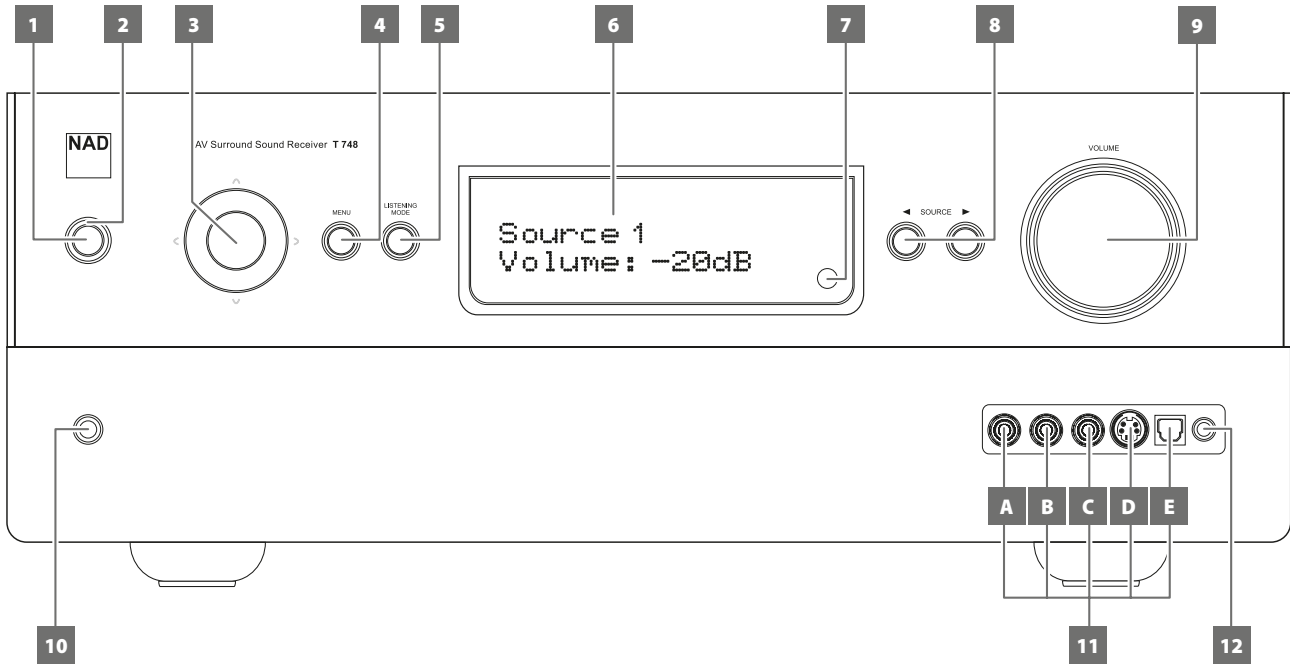

1 STANDBY BUTTON

- Press this button to switch ON the T 748 from standby mode. The Standby LED indicator will turn from amber to blue and illuminate the VFD. Pressing the STANDBY button again turns the unit back to standby mode.

2 STANDBY LED

- This indicator will light up amber when the T 748 is at standby mode.
- When the T 748 is powered up from standby mode, this indicator will illuminate blue.

3 NAVIGATION and ENTER BUTTONS

The navigation [</> / ^ / v] and [ENTER] buttons have various applications specific to given modes. The middle round button is designated as [ENTER] button; this is normally pressed to complete a selection, procedure, sequence or other applicable functions.

AM/FM mode

Toggle [ENTER] button to switch between "Tune" and "Preset" mode. Select "Tune" mode.

- Pressing momentarily the [</>] buttons will manually scan the AM or FM band.
- Press and hold [</>] for more than 2 seconds to search up/down; the T 748's tuner will stop at the next sufficiently strong signal it encounters.
- Note that this function "wraps" - that is, it will continue to search from one end of the AM or FM band to the other until it stops at a strong signal.

Toggle [ENTER] button to switch between "Tune" and "Preset" mode. Select "Preset" mode.

- Use [^ / v] to step up or down AM/FM Presets. Unused presets are skipped over. Note that Presets must have been previously stored.

Refer also to the item about STORING PRESETS (AM/FM) at the LISTENING TO AM/FM RADIO section of the OPERATION page.

DAB mode (230V version model only)

- Use front panel [</>] and [ENTER] buttons in combination with [MENU] button to select through applicable DAB menu options.

4 MENU

- Press to activate or deactivate OSD menu.
- At DAB mode, use the [MENU] button in combination with the front panel [</>] and [ENTER] buttons to activate DAB menu options.

5 LISTENING MODE

- Toggle to select through the various Listening mode options.
- Depending on the format of the currently selected input (digital or analog, stereo or multichannel), various listening modes are available.
- Refer also to the item about LISTENING MODE under the USING THE T 748 - MAIN MENU segment of the OPERATION section.

6 VACUUM FLUORESCENT DISPLAY (VFD)

- Displays visual information about the current settings like the active Source, volume level, listening mode, audio format, applicable RDS/DAB as well as iPod-related display information and other related indicators.
- Refer also to the item about DISPLAY SETUP under the USING THE T 748 - SETUP MENU segment of the OPERATION section.

7 REMOTE SENSOR

- Point the AVR 4 remote control at the remote sensor and press the buttons.
- Do not expose the remote sensor of the T 748 to a strong light source such as direct sunlight or illumination. If you do so, you may not be able to operate the T 748 with the remote control.

Distance: About 23ft (7m) from the front of the remote sensor.

Angle: About 30° in each direction of the front of the remote sensor.

8 SOURCE [◀▶]

- Toggle through the input selections - Source 1, Source 2, Source 3, Source 4, iPod, Source 7, Front Input, Media Player and Tuner (AM/FM/DAB as applicable). More Sources can be directly recalled upon enabling them at the Setup Menu.
- Refer also to the item about SOURCE SETUP under the USING THE T 748 - SETUP MENU segment of the OPERATION section.

9 VOLUME

- The VOLUME control adjusts the overall loudness of the signal being fed to the loudspeakers or headphones.
- Turn clockwise to increase the volume level; counter clockwise to lower it.

10 PHONES

- Accepts stereo headphone using a standard 1/4-inch stereo phone plug (use a suitable adaptor for headphones equipped with a smaller plug).
- Plugging in headphones automatically mutes output from the speakers.
- For headphone listening, the Front speakers must be set to "Large" at the "Speaker Configuration" of the Speaker Setup item at the Setup Menu; otherwise headphone bass response will be restricted.
- Plugging in headphones will automatically switch the T 748 to Stereo or Analog Bypass modes.

11 FRONT INPUT PORTS

- Use these convenience jacks for occasional sources such as a camcorder, video game console, any analog audio or optical digital audio sources and composite video sources.
- If your source has two output jacks indicative of stereo output, insert both jacks into the T 748's corresponding Front "L" (item A) and "R (MONO)" input to achieve stereo output as well.
- On the other hand, if your source has a single audio out jack only or is marked "Mono output", plug this into the T 748's Front "R (MONO)" input (item B).
- Connect composite video output source to the front composite video input (item C).
- Connect S-Video output source to the front S-Video input (item D).
- Use the front optical audio input (item E) for optical digital audio sources.

12 FRONT MP/MIC INPUT

- Connect your Media Player's standard stereo phone jack to this input.
- This is also same input where the supplied microphone is connected for speaker auto calibration.
- Refer also to the item about AUTO CALIBRATION under the USING THE T 748 - SETUP MENU segment of the OPERATION section.

IDENTIFICATION OF CONTROLS

REAR PANEL

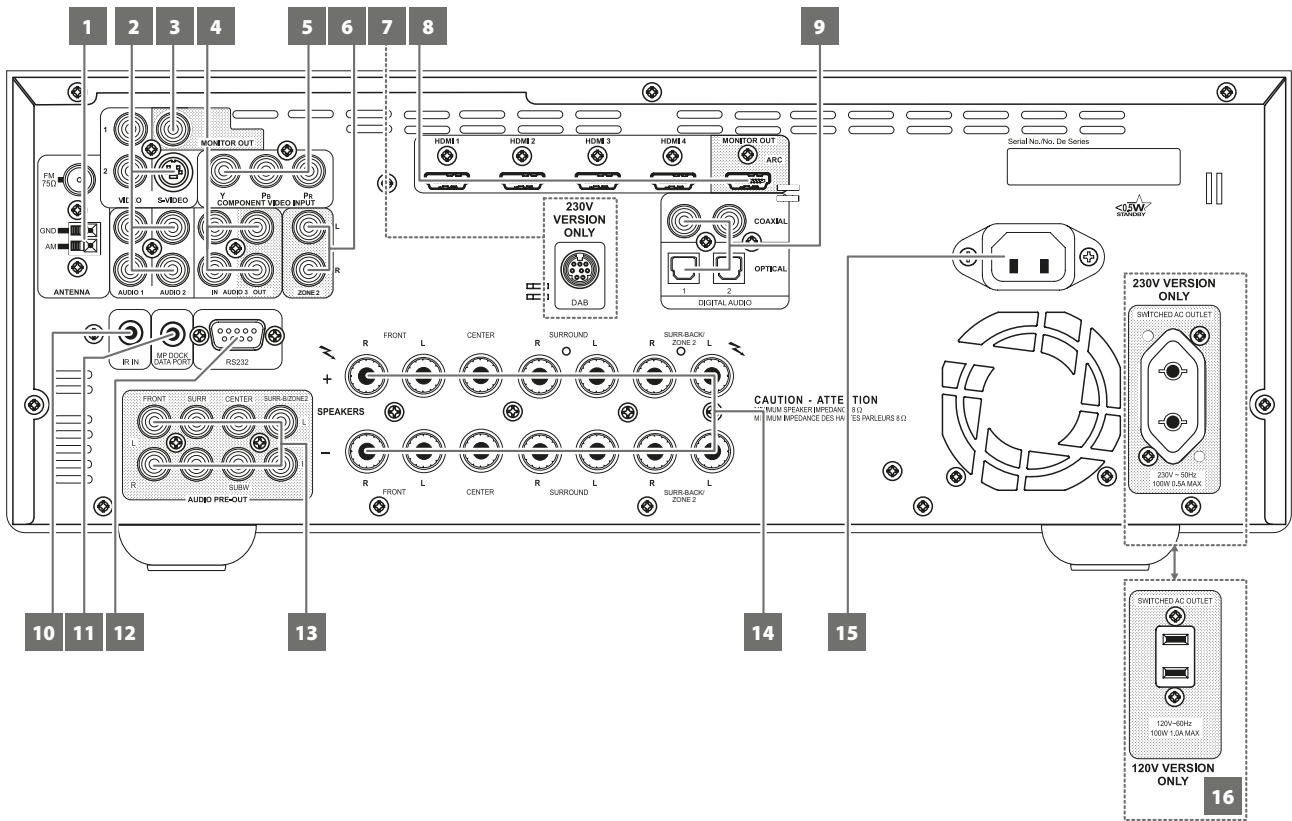

ATTENTION!

Please make sure that the T 748 is powered off or unplugged from the mains power source before making any connections. It is also advisable to power down or unplug all associated components while making or breaking any signal or AC power connections.

1 FM ANTENNA TERMINAL

- Connect the supplied lead-type FM antenna to the FM antenna input. Extend the lead. Experiment freely with your antenna placement and orientation until you get the clearest sound and lowest background noise. Fix the antenna in the desired position by using thumb tacks, push pins or any suitable means.

AM ANTENNA TERMINAL

The AM loop antenna supplied with the T 748 (or a suitable replacement) is required for AM reception.

- Connect the supplied AM loop antenna to these terminals. If an external AM antenna is used, make connections to the AM and GND terminals in accordance with the instructions supplied with the antenna.
- Testing different positions for the antenna may improve reception; vertical orientation will usually produce the best results. Antenna proximity to large metal objects (appliances, radiators) may impair reception, as will as attempts to lengthen the wire to the loop.
- Refer also to the item about ASSEMBLING THE LOOP ANTENNA at the LISTENING TO AM/FM RADIO section of the OPERATION page.

2 AUDIO 1-2/VIDEO 1-2/S-VIDEO

- These comprise the T 748's other sets of principal input. Connect these S-Video, composite video, and analog audio input ports to the corresponding output ports of source components such as DVD players or cable/satellite boxes.
- AUDIO 2 IN and S-VIDEO IN are the assigned default ports for the audio/video output of the separately sold NAD IPD (NAD IPD Dock for iPod) 1, NAD IPD 2 and later variants.

3 MONITOR OUT

- Connect to the video input of a monitor/television using quality dual-RCA cables designed for video signals.

4 AUDIO 3 IN/OUT

- Connect AUDIO 3 OUT to the corresponding analog audio input of a recording component such as a cassette deck, CD recorder or to an outboard audio/video processor. Connect AUDIO 3 IN to the component's corresponding analog audio output connectors.
- The signal present at the AUDIO 3 OUT is determined by the source last selected via the front panel Source keys or the AVR 4's input select keys with the exception of Source 3 or Source 4. If the default settings are maintained for both Source 3 and Source 4 (analog audio input is AUDIO 3) and both their respective digital audio input is set to "Off", there will be no output at AUDIO 3 OUT when Source 3 or Source 4 is selected. This prevents feedback through the recording component thereby preventing possible damage to your speakers.

5 COMPONENT VIDEO INPUT

- Connect the Component Video Input to Component Video output of compatible source components, typically a DVD player, BD player, digital cable box or other applicable components.
- Be sure to observe consistency in connecting the Y/Pb/Pr jacks to the corresponding sources.

6 ZONE 2

- Send zone selected audio source to the corresponding audio input of a separately located additional amplifier or receiver (not supplied) that can power its matching set of speakers.
- Use high quality patch cables to reduce noise pickup over long distance runs.

7 DAB MODULE INPUT (230V version model only)

The T 748 is compatible only with the NAD DAB Adaptor module models DB 1 or DB 2.

- Plug-in the other end of the Mini-Din connector from the NAD DAB Adaptor module output port into this socket.
- With DAB, you can receive CD-like quality programs without any annoying interference and signal distortion.
- Refer also to the "LISTENING TO DAB RADIO" segment of the "OPERATION" section.

NOTE

The external NAD DAB Adaptor module is not supplied with your T 748.

8 HDMI (HDMI 1-4, HDMI MONITOR OUT)

- Connect the sets of HDMI input to the HDMI OUT connectors of source components such as DVD player, BD player or HDTV satellite/cable box. Connect the HDMI Monitor OUT to a HDTV or projector with HDMI input.

WARNING

Before connecting and disconnecting any HDMI cables, both the T 748 and the ancillary source must be powered OFF and unplugged from the AC outlet. Failure to observe this practice may cause permanent damage to all equipment connected via HDMI sockets.

9 DIGITAL AUDIO (COAXIAL 1-2, OPTICAL 1-2)

- Connect to the corresponding optical or coaxial digital output of sources such as CD or BD/DVD players, digital cable box, digital tuners and other applicable components.
- Coaxial and Optical digital input association is configurable via the Source Setup item of the Setup Menu OSD.

10 IR IN

- This input is connected to the output of an IR (infrared) repeater (Xantech or similar) or the IR output of another component to allow control of the T 748 from a remote location.

11 MP DOCK

The T 748 is equipped with a data port in the rear panel where an optional NAD IPD (NAD IPD Dock for iPod) 1, NAD IPD 2 and later variants can be plugged in.

- Connect the "MP DOCK (DATA PORT)" jack of the T 748 to the corresponding "DATA PORT" socket of the optional NAD IPD model.
- AUDIO 2 IN and S-VIDEO IN are the assigned default ports for the audio/video output of the separately sold NAD IPD (NAD IPD Dock for iPod) 1, NAD IPD 2 and later variants.
- Refer also to the "LISTENING TO YOUR iPod PLAYER" segment of the "OPERATION" section.

NOTE

The NAD IPD Dock for iPod is not supplied with your T 748.

12 RS 232

NAD is a certified partner of AMX and Crestron and fully supports these external devices. Check out the NAD website for information about AMX and Crestron compatibility with NAD. See your NAD audio specialist for more information.

- Connect this interface using RS-232 serial cable (not supplied) to any Windows compatible PC to allow remote control of the T 748 via compatible external controllers.

13 AUDIO PRE-OUT/ZONE 2

- The AUDIO PRE- OUT makes it possible to use the T 748 as a pre-amplifier to external power amplifiers for some or all channels. Connect FRONT L, FRONT R, CENTER, SURR R, SURR L, SURR-BL and SURR-BR to the respective channel input of a power amplifier or amplifiers driving the corresponding applicable speakers.
- SURR-BL and SURR-BR are also assigned as secondary ZONE 2 OUT. This is applicable only if "Zone 2" is the selected setting of "Back Amp" in the "Amplifier Setup" menu. For further information, refer to the item about ZONE 2 CONTROLS at the USING THE T 748 - MAIN MENU segment of the OPERATION section.
- Unlike the full range channels, there is no power amplifier built-into the T 748 for a subwoofer. Connect the SUBW output to powered ("active") subwoofers or to power amplifier channels driving a passive system.

NOTE

Never connect both the external amplifier and T 748's speaker outputs to the same set of speakers.

14 SPEAKERS

- Connect the respective speaker's FRONT L, FRONT R, CENTER, SURR R, SURR L, SURR-BACK L, and SURR-BACK R channels to their corresponding loudspeakers. Make sure the "+" (red) terminal and "-" (black) terminal are connected to the corresponding "+" and "-" terminals of the loudspeaker. Use extra care to ensure that no stray wires or strands cross between posts or terminals at either end.
- SURR-BACK L and SURR-BACK R can be assigned as Zone 2 speaker level output. This is applicable only if "Zone 2" is the selected setting of "Back Amp" in the "Amplifier Setup" menu. For further information, refer to the item about ZONE 2 CONTROLS at the USING THE T 748 - MAIN MENU segment of the OPERATION section.

NOTE

Use stranded wire of at least 16 gauge (AWG). Connections to the T 748 can be made with banana-type plugs. Bare wire or pins can also be used by loosening the terminal's plastic nut, making a clean, neat connection, and re-tightening carefully. To minimize the danger of short circuit, ensure that only 1/2-inch of exposed wire or pin is employed when connecting.

15 AC MAINS INPUT

The T 748 comes supplied with a separate detachable mains power cord. Before connecting the plug to the mains power source, ensure that it is firmly connected to the T 748's AC Mains input socket first.

- Connect only to the prescribed AC outlet, i.e., 120V 60 Hz (for 120V version models only) or 230V 50 Hz (for 230V version models only).
- Always disconnect the mains power plug from the mains power source first, before disconnecting the cable from the T 748's AC Mains input socket.

16 SWITCHED AC OUTLET

This convenience outlet can supply switched power to another component or accessory.

- The total draw of all devices connected to this outlet must not exceed 100 watts.
- It is powered ON and OFF by the front panel STANDBY button or by the AVR 4's ON and OFF keys.

IDENTIFICATION OF CONTROLS

AVR 4 REMOTE CONTROL

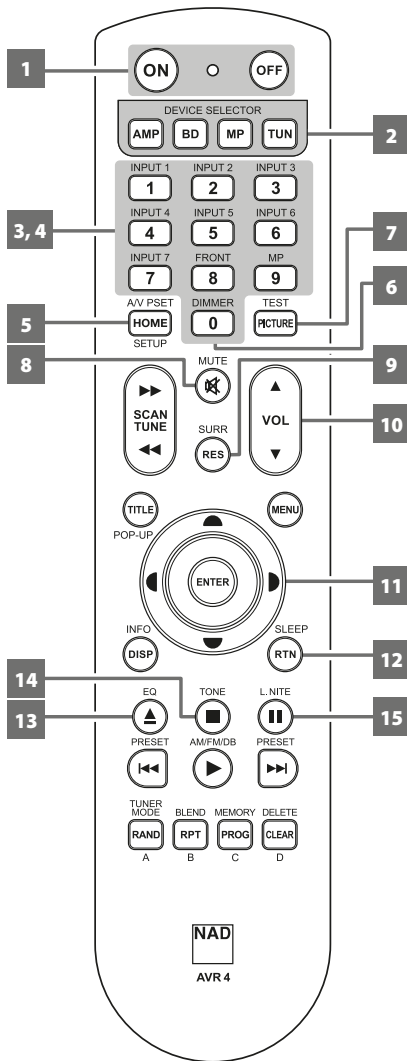

USING THE AVR 4 REMOTE CONTROL

The AVR 4 remote control handset handles the key functions of the T 748. The AVR 4 can also be used to directly command other NAD products that respond to applicable common remote control codes. This includes other NAD Stereo Receiver, Integrated Amplifier and Preamp models. It has additional controls to remotely operate NAD CD Players, AM/FM Tuners and dedicated AM/FM/DAB Tuners. It will operate up to a distance of 23ft (7m). Alkaline batteries are recommended for maximum operating life. Two AA batteries should be fitted in the battery compartment at the rear of the Remote Control handset. When replacing batteries, check that they have been put in the right way round, as indicated on the base of the battery compartment.

NOTE

The remote control handset supplied with the T 748 is of a universal NAD type, designed to operate several NAD models. Some buttons are applicable only to specific NAD models. Contact your dealer or NAD audio specialist for assistance.

1 ON, OFF

The AVR 4 remote has a separate ON and OFF button.

- Press ON button to switch the T 748 from Standby to operating mode. Press OFF button to switch the T 748 to Standby mode.

2 DEVICE SELECTOR

A Device Selector button determines only what component the AVR 4 will command; it does not perform any function on the T 748.

- Press desired Device Selector button for the applicable buttons to be directed to a "page" of commands relevant to the selected device. Upon selecting a Device, you can now press the corresponding AVR 4 control buttons applicable for the selected Device.

3 INPUT SELECTORS

Refer to the corresponding labels printed in the remote control faceplate and their respective assigned buttons to make use of these functions.

- Set the DEVICE SELECTOR to "AMP" in order to gain access to these buttons.
- INPUT 1, INPUT 2 up to INPUT 5 corresponds to T 748's Source 1, Source 2 up to Source 5. Select FRONT to select Front Input and MP for Front Audio MP input.

4 NUMERIC KEYS

The numeric keys allow for direct input of tracks for CD players and direct channel/preset access for tuners and receivers.

5 A/V PSET

In combination with the numeric keys, press a Preset number from 1 to 5 as referenced to A/V Presets settings. Note that the Preset settings can be configured via the A/V Presets menu.

6 DIMMER

- Reduce or restore VFD brightness.
- Depending on the NAD model, the brightness of the front panel display will vary when you toggle this button.
- Use with NAD T 748 and other compatible NAD Stereo Receiver, Tuner and CD Player models.

7 TEST

Initiate speaker TEST mode while at the Speaker Levels section of the Speaker Setup menu.

8 MUTE

- Temporarily mutes audio output or restores audio from mute mode.
- MUTE mode is indicated by flashing Standby LED indicator for NAD Integrated Amplifiers or "Mute" shown in the VFD of NAD Receivers.
- Adjusting the volume level via the AVR 4 or the front panel volume knob will automatically release the mute function.

9 SURR

Select desired listening or surround mode.

10 ▲ VOL ▼

- Increase or decrease loudness level. Release the button when desired level is reached.
- The VFD on the front panel will indicate the level set. For NAD Receivers, the VFD will also show "Volume Up" or "Volume Down" or "Volume: __ dB" (__ indicates the numerical dB level) while pressing AVR 4's [VOL ▲/▼] buttons.

11 ▲/▼/◀/▶, ENTER

Select an item in a menu.

12 SLEEP

Switch off the NAD Receiver or Tuner after a preset number of minutes.

SLEEP MODE

The Sleep Mode timer will switch the T 748 to Standby mode automatically after a preset number of minutes. Pressing the AVR 4's [SLEEP] button once will display the current setting of the sleep time mode or remaining time before the T 748 goes to standby mode. Pressing the AVR 4's [SLEEP] button a second time within a 3-second period will change the sleep time mode to the next sleep time setting. Each consecutive press increases the sleep time in 15-minute increments from 15 to 90 minutes. To cancel the sleep mode, continue pressing the AVR 4's [SLEEP] button until "Sleep Off" is displayed on the VFD. Switching the T 748 to standby mode from either the AVR 4's OFF or the T 748's Standby button will also cancel the sleep mode.

13 EQ

Enable or disable Equalization (EQ) effect as set up at Auto Calibration.

14 TONE

Adjust Treble or Bass level. Toggle [TONE] and then use [▲/▼] buttons to set up tone level.

15 L.NITE

Set Dynamic Range Control (DRC) level. Toggle [L.NITE] to select either DTS or Dolby DRC setting and then use [▲/▼] buttons to set up DRC level.

DVD/BD/CD PLAYER CONTROL (USE WITH COMPATIBLE NAD CD PLAYER, BLU-RAY DISC PLAYER OR DVD PLAYER MODELS)

Set the DEVICE SELECTOR to "BD" in order to gain access to these buttons. Some of the control buttons below are applicable only to specific NAD CD Player, Blu-ray Disc or DVD Players; check the owner's manual of your NAD model for control button compatibility. You can also load the applicable NAD code library to this device so that it can be made compatible with your other NAD equipment. Refer to the section below about "LIBRARY" on how to load a NAD code library.

HOME: Display or exit HOME menu.

PICTURE: Display or exit the Picture Mode menu.

TITLE/POP-UP: Display DVD title menu or BD-ROM pop-up menu, if available.

MENU: Access disc menu, if available.

SCAN [◀◀/▶▶]: Fast reverse/forward search.

[▲]: Open or close disc tray.

[■]: Stop playback.

[||]: Pause playback temporarily.

[▶▶]: Go to next track, chapter or file.

[◀◀]: Go to the beginning of current or previous track, chapter or file.

[▶]: Start playback.

ENTER: Select desired track, folder or WMA/MP3 file.

DISP: Show playback time and other display information.

RAND: Play tracks/files in random order.

RPT: Repeat track, chapter, file or whole disc.

PROG: Enter or exit program mode.

CLEAR: Delete programmed track/file.

RES: Set output resolution of HDMI and Component Video output.

SETUP: Access or exit setup menu.

A,B,C,D: Navigate or select BD-ROM menu, if applicable; Page up/down PHOTO and MUSIC menu list.

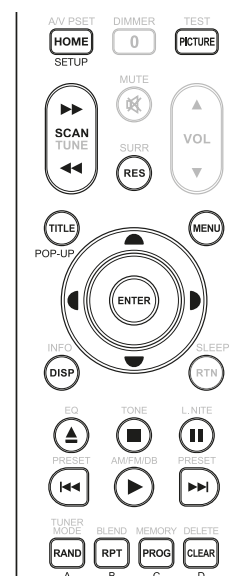

IDENTIFICATION OF CONTROLS

AVR 4 REMOTE CONTROL

ENGLISH

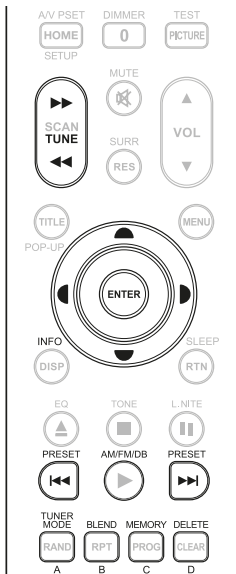

TUNER CONTROL (USE WITH T 748 TUNER SECTION AND OTHER COMPATIBLE NAD RECEIVER, AM/FM/DAB TUNER MODELS)

Set the DEVICE SELECTOR to "TUN" in order to gain access to these buttons. Refer to the corresponding labels printed in the remote control faceplate and their respective assigned buttons to make use of these functions. Some of the control buttons below are applicable only to specific NAD Receiver or Tuner models; check the owner's manual of your NAD Receiver or Tuner for control button compatibility. You can also load the applicable NAD code library to this device so that it can be made compatible with your other NAD equipment. Refer to the section below about "LIBRARY" on how to load a NAD code library.

TUNE [◀▶] or [◂◃]: Tune forward or backwards.

INFO: Repeatedly pressing this button will show information as supplied by the current radio station. The applicable display contents include related DAB display information and RDS broadcast data.

PRESET [◀▶▶] or [▲▼]: Step up or down Preset numbers.

[◂◃]: In combination with [TUNER MODE] or other compatible buttons, select through applicable DAB menu options.

ENTER: Select Preset or Tune mode at AM/FM band. Display signal strength at DAB mode.

AM/FM/DB: Select DAB, FM or AM band, as applicable.

TUNER MODE: In FM mode, toggle between "FM Mute On" and "FM Mute Off". At DAB mode, use the [TUNER MODE] button in combination with the front panel [◂◃] and [ENTER] buttons to activate DAB menu options.

BLEND: Engage or disengage BLEND feature. This is not applicable to T 748.

MEMORY: Save current station to a Preset number.

DELETE: Delete selected Preset number.

NOTE

For iPod player-specific control buttons, please refer to "CONTROL FEATURES" under "OPERATION - LISTENING TO YOUR iPod PLAYER".

LIBRARY

The AVR 4 can store a different library of default NAD codes for each of its DEVICE SELECTOR "pages." If the original default library does not control your NAD CD player, DVD player, or other component, follow the procedure below to change the library code. Refer as well to the table below for a list of applicable NAD Library Codes with their corresponding NAD models.

LOAD ANOTHER LIBRARY CODE

Example: Load NAD DVD Player T 517 library code to AVR 4's "BD" device.

- 1 Press and hold [BD] in the DEVICE SELECTOR section of AVR 4.
- 2 While holding down the device button [BD], press "2" and "2" using AVR 4's numeric buttons. "22" is the corresponding library code for T 517.
- 3 Press [ENTER] while still holding down the device button [BD]. The BD device selector will flash once to indicate that the library input is successful. Both the device selector button [BD] and [ENTER] can now be released.

IDENTIFICATION OF CONTROLS

AVR 4 REMOTE CONTROL

RESET THE AVR 4 TO ITS DEFAULT SETTINGS

The AVR 4 can be restored to its factory settings, including default libraries, via the following procedures

- 1 Press and hold [ON] and [DELETE] buttons for about 10 seconds until the AMP device button lights up.
- 2 Within two seconds of the AMP device button lighting up, release both buttons. If the reset mode is successful, the [BD] device button will flash twice.

TABLE OF LIBRARY CODES APPLICABLE TO AVR 4 REMOTE CONTROL

LIBRARY CODE	NAD PRODUCT DESCRIPTION
10	Default library for "AMP" page
11	Zone 2
20	C 515BEE, C 545BEE, C 565BEE
21	T 535, T 585, M55; DVD section of L 54, VISO TWO, VISO FIVE
22	T 513, T 514, T 515, T 517
23	T 587, T 557, T 577, M56
30	IPD 1
31	IPD 2
40	Default library for "TUN" page; Tuner section of C 725BEE, T 175, T737, T 748, T 755, T 765, T 775, T 748
41	C 422, C 425, C 426
42	C 445

NOTE

The AVR 4 may not necessarily contain all the control buttons applicable for the above-mentioned NAD products. Use the prescribed remote control of the specific NAD product for a full compliment of the applicable remote control buttons.

USING THE ZR 7 REMOTE CONTROL

The ZR 7 is a discrete compact remote for controlling the Zone 2 feature of the T 748. Irrespective of the main room/zone settings, the ZR 7 allows full separate control of the Zone 2 source selection among other applicable features.

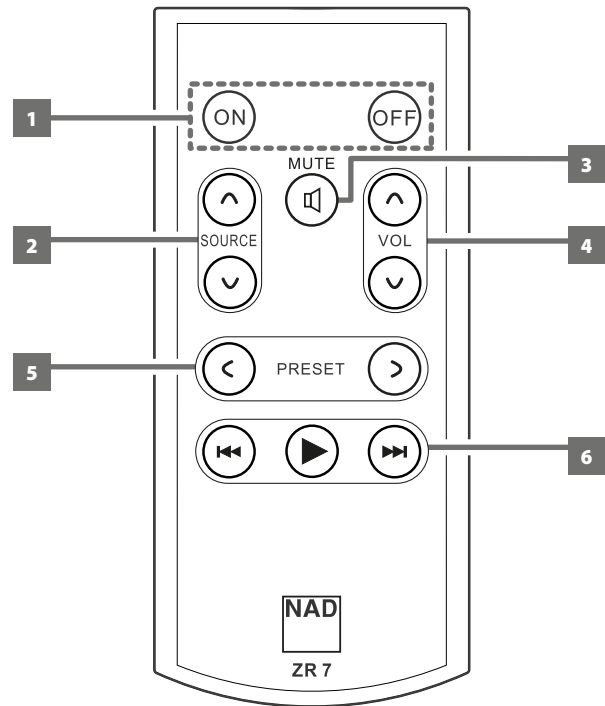

- 1 **ON/OFF**: Switch ON/OFF the Zone feature.
- 2 **SOURCE [^/∨]**: Select the active input of the NAD T 748 that will be sent out to the corresponding rear panel ZONE 2 output port.
- 3 **MUTE**: Temporarily switch OFF or restore the Zone Volume level.
- 4 **VOLUME [^/∨]**: Increase or decrease Zone 2 audio output level. This is applicable only when Zone 2 is the selected setting of "Back Amp" in the "Amplifier Setup" menu.
- 5 **PRESET [</>]**: Step up or down between stored radio presets. This control button is possible if the selected Zone is "TUNER" and the active tuner section has stored presets.
- 6 The following CD Player Zone buttons can control a compatible CD Player. The CD Player has to be powered ON and disc loaded.
SKIP [►►]: Go to the beginning of a track/file or previous track/file.
SKIP [◀◀]: Go to the next track/file.
[►]: Start playback.

OPERATION

USING THE T 748 - MAIN MENU

ABOUT THE ON-SCREEN DISPLAY (OSD)

The T 748 employs a simple, self-explanatory system of on-screen display "menus" that will appear on the connected video monitor/TV. These are required during the setup process (and are useful in day-to-day operation), so be sure to connect the monitor/TV before proceeding with the setup.

DISPLAY THE OSD

Press [**▶**] or [MENU] buttons of the AVR 4 remote control or the front panel buttons [**>**] or [MENU] to display the T 748's Main Menu on your video monitor/TV. If the OSD does not appear, check your MONITOR OUT connections.

NAVIGATING THE OSD AND MAKING CHANGES

Use applicable AVR 4 or corresponding front panel buttons to navigate through the OSD menu options.

- 1 Press [**▶**] to select a menu item. Use [**▲/▼**] or in some cases, [ENTER], to move up or down the menu selections. Repeatedly press [**▶**] to advance or go further into the sub-menu of desired menu item.
- 2 Use [**▲/▼**] to set or change the parameter value (setting) of a menu item.
- 3 Press [**◀**] to save the settings or changes done on the current menu or sub-menu. Pressing [**◀**] will also return the user to the previous menu or exit from a particular menu.

IMPORTANT NOTE

Unless otherwise specifically stated, references to control buttons in the succeeding sections are with respect to AVR 4 buttons. Equivalent front panel buttons apply when applicable.

MAIN MENU

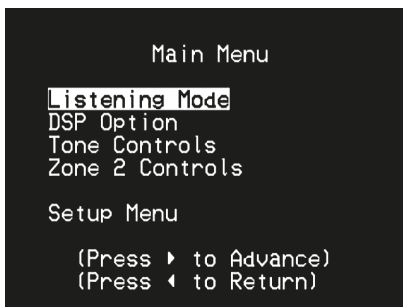

The Main Menu contains the menu options for "Listening Mode", "DSP Option", "Tone Controls", "Zone 2 Controls" and access to "Setup Menu".

Follow the guidelines about "DISPLAY THE OSD" and "NAVIGATING THE OSD AND MAKING CHANGES" to navigate through the menu options and their sub-menu selections.

NOTE

The individual configurations set forth at "Listening Mode", "DSP Option" and "Tone Controls" are carried over whenever they are enabled at "A/V Presets Setup" setting. Please see the section "A/V Presets Setup" for reference.

LISTENING MODE



The T 748 offers distinct listening modes, tailored for different types of recording or program material. With a two-channel (Stereo) source, the following listening modes can be selected.

STEREO

Output is directed to the front left/right channels. Low frequencies are directed to the subwoofer if one is present in the Speaker settings. Select "Stereo" when you wish to listen to a stereo (or monaural) production, such as music CD or FM broadcast, without surround enhancement. Stereo recordings whether in PCM/digital or analog form and whether surround-encoded or not encoded, are reproduced as recorded. Multi-channel digital recordings (Dolby Digital and DTS) are reproduced in "Stereo Downmix" mode via the front left/right channels only as Lt/Rt (left/right-total) signals.

DIRECT

The analog or digital sources are automatically played in their native formats. All the source's audio channels are reproduced directly. This mode recreates the original sound most faithfully thereby producing outstandingly high quality audio. Note that the source must be at playback mode for "Direct" to become available as a listening mode option. In order to automatically playback your source in their native format, implement the following settings.

- 1 Go to "Listening Mode Setup" under "Setup Menu". At the "Listening Modes" menu, set all Dolby Digital, DTS, PCM and Analog settings to "None". With this setup, your source will be played back directly at its native format.
- 2 Next, go to "A/V Presets Setup" under "Setup Menu". At "A/V Presets Setup" menu, set "Listening Mode" item to "Yes" and then save this setting among other options, say to "Preset 1", by selecting "Save Settings to Setup".
- 3 Now, you can associate "Preset 1" to any of the "Source" settings. For example, at Source 1 setting under "Source Setup (Normal)", scroll down to "A/V Preset" item and set it to "Preset 1". Thus whenever Source 1 is selected, the associated source will always be directly played back at its native audio format.

DOLBY PRO LOGIC IIx

Dolby Pro Logic Iix processes both stereo and 5.1 signals into a 6.1 or 7.1 channel output. At Dolby Pro Logic Iix, you can either choose PLIix Movie or PLIix Music mode to tailor your listening experience to the source material. Dolby Pro Logic Iix surround processing yields more stable imaging and full bandwidth sound to the rear channels in Movie mode offering sound that is more similar to Dolby Digital decoding. For two channel signals, PLIix Music mode also features three additional user controls – Dimension, Center Width, and Panorama. See also section about “Adjusting Listening Modes” below.

The following chart shows the channels available assuming they are enabled in the “Speaker Configuration” menu:

Listening Mode Two-Channel Sources	Active Decoded Output Channels	
	6.1 Speaker System	7.1 Speaker System
PLIix Music PLIix Movie	Front (left and right), Center, Surround (left and right), Back Surround, Subwoofer	Front (left and right), Center, Surround (left and right), Back Surround (left and right), Subwoofer

NEO: 6

Two-channel recordings, whether stereo or surround-encoded, are reproduced with NEO:6 surround with output to front left/right, center and discrete left/right surround channels plus subwoofer (assuming these are present in the current “Speaker Configuration”). The T 748 provides two DTS NEO:6 variations – NEO:6 Cinema and NEO:6 Music. See also section about “Adjusting Listening Modes” below.

EARS

Two-channel recordings, whether stereo or surround-encoded, are reproduced with proprietary NAD surround processing with signal output to the front left/right, center and discrete left/right surround channels, plus subwoofer (assuming these are present in the current “Speaker Configuration”). EARS does not employ the surround back speakers (if any).

EARS extracts the natural ambience present in nearly all well-produced stereo recordings. It does not synthesize any ambience or other sonic elements and thus remains truer to the sound of the original musical performance than most other music-surround options.

Select EARS for listening to stereo music recordings and broadcasts. EARS produces a subtle but highly natural and believable ambience from nearly all “natural-acoustic” stereo recordings. Typically, these include classical, jazz, and folk genres as well as numerous examples from others. Its virtues include realistic, stable “front-stage” sonic imaging and spacious but unexaggerated ambient “virtual acoustics” that remain faithful to the original recording.

ENHANCED STEREO

All recordings are reproduced in stereo via the maximum speaker complement configured in the current “Speaker Configuration”. Enhanced stereo can be useful for maximum volume from all channels or for multi-speaker background music (cocktail party) listening. For this mode, Front, Center, Surround and Back speakers can be turned ON/OFF as desired.

ANALOG BYPASS

All analog signals remain in the analog domain without analog-to-digital conversions. At Analog Bypass, the DSP circuitry is bypassed but full tone control functions remain. “Bass management” or Speaker settings are also not in effect as these are DSP functions.

ADJUSTING LISTENING MODES

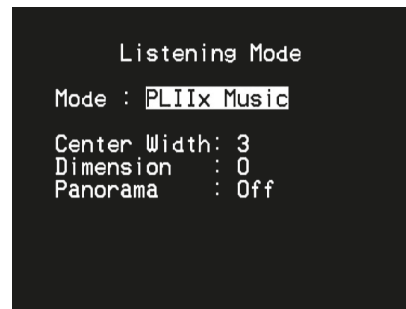

Several of the T 748’s listening modes have one or more selectable variations and adjustable parameters that you can modify to suit your system or personal preferences. At Listening Mode menu, use a combination of [▲/▼] keys to navigate and achieve desired settings.

NOTE

Listening Mode parameter changes are maintained when you change listening modes. You may also save a modified Listening Mode for easy recall by saving it to a Preset (See “AV Presets Setup” below under Setup Menu discussions).

PRO LOGIC IIx

PLIix MOVIE is optimized for film soundtracks.

PLIix MUSIC for music recordings.

Center Width (0 to 7): Modifies the “hard-centeredness” of the center image, by gradually mixing mono center content to the Front left/right speakers as well. A setting of “0” retains the center-channel-only default while a setting of “7” yields a fully phantom center channel.

Dimension (-3 to 3): Adjusts front-rear emphasis of the surround effect independently from the relative channel levels.

Panorama (On/Off): Adds a “wraparound” effect by extending some stereo content into the surround channels.

NOTE

Pro Logic Iix mode will decode as Pro Logic II mode when the BACK surround speakers are set to “Off” from “Speaker Configuration” menu. See also section about “Speaker Configuration” under “Speaker Setup” of the Setup Menu.

DTS NEO: 6

NEO:6 Cinema is optimized for film soundtracks.

NEO:6 Music for music recordings

Center Gain (0 to 0.5): Adjust for better center image in relation to the surround sound channels.

OPERATION

USING THE T 748 - MAIN MENU

DSP OPTION

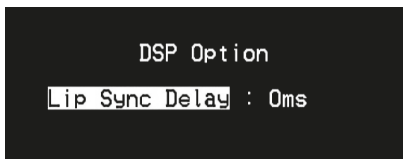

LIP SYNC DELAY

DSP Options has the feature "Lip Sync Delay" whose function is to match any delay that may occur in the picture relative to the audio.

By varying "Lip Sync Delay" from 0ms to 120ms, one can delay the audio output in order to synchronize it with the video image.

TONE CONTROLS

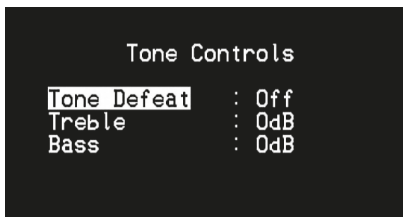

The T 748 has two Tone Control levels – Treble and Bass. Bass and Treble controls only affect the low bass and high treble leaving the critical midrange frequencies free of coloration.

These controls allow one to tweak on-the-fly, the frequency response of the source during playback. The control setting could be adjusted by navigating through the Tone Controls OSD menu via a combination of [ENTER] and [▲/▼/◀/▶] keys.

Maximum and minimum values for all three Tone Control levels are ± 10 dB.

"Tone Defeat" gives one the choice of varying or completely bypassing the tone control section of the T 748. If "Off" is selected, the Tone Control circuits are active.

Select "On" to bypass the Tone Controls effectively defeating the effect of the tone control circuits.

ZONE 2 CONTROLS

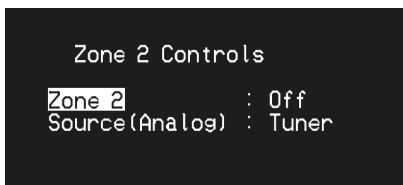

The Zone feature allows one to simultaneously experience in a different zone of the house selected audio from any of the enabled Sources as well as from iPod, Front, MP and Tuner.

Select "On" to activate Zone 2. When activated, the Source input for Zone 2 can be allocated by selecting through the following inputs – All enabled Sources, iPod, Front, MP and Tuner.

As long as the associated Source input is active, it will continuously be available at ZONE 2 output port in the rear panel regardless of the Main Zone settings. For example, while the T 748 is at Source 1 mode, you can set the Zone 2 Controls "Source" item to "Source 3"; the active Source 3's audio output will be directed to ZONE 2 output port in the rear panel even though the T 748 is at Source 1 mode.

You can then feed the ZONE 2 jacks to another amplifier or receiver that maybe located in another area of your home or building. With your separate amplifier or receiver selecting the fed signal and with speakers connected, you can then enjoy the zone selected source's audio signal. Adjust the volume control of your amplifier or receiver according to desired audio level.

If a Zone 2 is set to "Off", it is deactivated or powered off.

ZONE 2 AT AUDIO PRE-OUT SURROUND BACK

SURR-BACK L and SURR-BACK R channels of AUDIO PRE-OUT can be assigned as Zone 2 OUT. This is applicable only if "Zone 2" is the selected setting of "Back Amp" in the "Amplifier Setup" menu.

With this condition, the following are applicable

- The surround back amplifier channels supply Zone 2 speaker level output via the surround back speaker terminals. With this setup, Zone 2 audio/speaker level can be increased or decreased using the VOL (Volume) keys of the supplied ZR 7 zone remote control.
- At the same time, Zone 2 (item 6 "ZONE 2" in the "IDENTIFICATION OF CONTROLS" section) continues to send zone selected audio source to the corresponding audio input of a separately located additional amplifier or receiver (not supplied) that can power its matching set of speakers. Zone 2 audio level for this port is fixed; it cannot be adjusted by any ZR 7 volume command.
- On the other hand, the secondary Zone 2 at AUDIO PRE-OUT (item 13 "AUDIO PRE-OUT/ZONE 2" in the "IDENTIFICATION OF CONTROLS" section) also sends zone selected audio source to the corresponding audio input of a separately located additional amplifier or receiver (not supplied) that can power its matching set of speakers. Zone 2 audio output for this secondary Zone 2 can be increased or decreased using the VOL (Volume) keys of the supplied ZR 7 zone remote control.
- For the applicable Zone 2 function, Zone 2 audio level can only be adjusted using the Volume keys of ZR 7 remote control only if "Back Amp" in the "Amplifier Setup" menu is set to "Zone 2". Setting "Back Amp" to "Main Front" or "Main Back" will not allow Zone 2 audio level adjustment.

IMPORTANT NOTICE

Only analog audio connected through a Source's analog audio input port can be associated as audio source for Zone 2. Digital audio sources connected via HDMI, digital optical and digital coaxial input ports cannot be downmixed and used as Zone 2 audio source.

NOTES

- If Zone 2 is still ON and STANDBY button is pressed to switch the T 748 to standby mode, the VFD will be extinguished except for the display showing Zone 2 and associated Zone 2 source. Standby LED remains illuminated blue. This indicates that Zone 2 is still active. In order to completely shut down the T 748, "Zone 2" setting at the "Zone 2 Controls" menu must be set to "Off". Pressing "OFF" button of the ZR 7 remote control will also directly turn off Zone 2.
- Zone 2 is audio only and not associated with any video input sources.

SETUP MENU

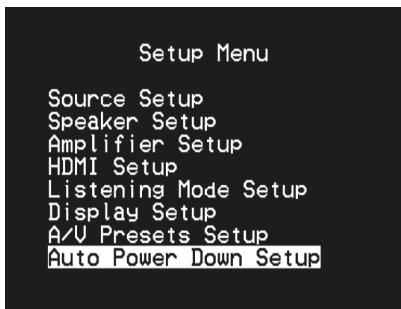

The Setup Menu allows one to customize the operation of the T 748 to the ancillary equipment used in one's specific AV system. Unless your system exactly matches the factory defaults, you will need to use the setup menu to configure the inputs of the T 748.

At Setup Menu, the following are configurable – Source Setup, Speaker Setup, Amplifier Setup, HDMI Setup, Listening Mode Setup, Display Setup, AV Presets Setup and Auto Power Down Setup.

Follow the guidelines about "DISPLAY THE OSD" and "NAVIGATING THE OSD AND MAKING CHANGES" to navigate through the menu options and their sub-menu selections.

SOURCE SETUP

There are three sub-menu items under Source Setup. These are Source Setup (Normal), Source Setup (Table) and iPod Setup.

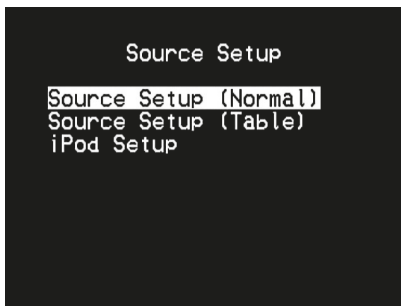

SOURCE SETUP (NORMAL)

The Source Setup (Normal) menu makes it possible to set, allocate or change the following settings.

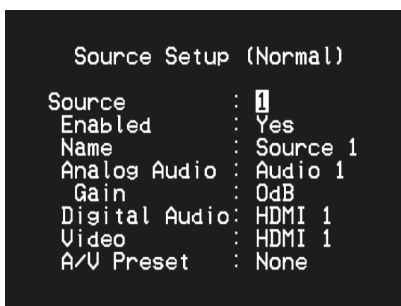

SOURCE

The T 748 is equipped with eight configurable Sources. A particular Source can be enabled or disabled, renamed, assigned analog and digital audio sources, video sources, A/V Presets among other settings.

These settings can be implemented through the following parameters.

NOTE

Source 5 is defaulted to iPod. Remove the default setting of Source 5 to iPod via the following procedure

- 1 Go to "iPod Setup" menu under the "Source Setup" menu. At "iPod Setup" menu, set "Enabled" to "No".
- 2 Then, go back to "Source Setup" menu and select "Source Setup (Normal)".
- 3 Go to Source 5 and set "Enabled" to "Yes".
Source 5 can now be configured to any desired settings.

ENABLED

One can enable/disable a Source via this option. This is particularly useful if only few Sources are used and one directly selects the Source from the front panel, bypassing unused sources.

Select "Yes" to enable the particular Source or "No" to disable the Source.

NAME

A new Name maybe assigned to a Source label. For example, if your BD player is attached to "Source 1", it is possible to rename "Source 1" to "BD".

In order to rename the Source label, scroll to the "Name" parameter. Press [D] to go to the first character. Then, press [▲/▼] to pick through the alphanumeric selections.

Press [D] to move to the next character and at the same time save the changes done on the current character. The name can be as long as eight characters.

The new Name will be shown in the VFD as well as on the OSD.

ANALOG AUDIO

The T 748 has five analog audio inputs. These analog inputs - Audio 1, Audio 2, Audio 3, Audio Fr (Front) and Audio MP can be variably assigned to each Source.

Scroll to "Analog Audio" and then press [D] and then [▲/▼] to select and assign an analog audio input to the particular Source.

NOTE

An incoming digital signal present at the assigned digital input will always take precedence over the assigned analog audio input, even if both are present. To maintain the analog audio input for the particular Source, select "Off" at the "Digital Audio" setting of the same "Source" menu.

GAIN

Gain adjustment allows all sources to play back at the same volume level so you don't need to adjust the volume every time a new source is selected. It is generally preferable to reduce the level of the loudest source rather than making louder the softer sources.

Scroll to "Gain", press [D] and then [▲/▼] to step through the desired level from -12dB to 12dB.

OPERATION

USING THE T 748 – SETUP MENU

DIGITAL AUDIO

To take advantage of the T 748's high performance surround and digital audio circuitry, it is advisable that its Digital Audio inputs are selected.

There are three types of Digital Audio input for the T 748. These are HDMI, Optical and Coaxial digital inputs. A fourth option is "Off" whereby no incoming digital audio signal is selected by the particular Source.

The desired digital audio input for a particular Source can be selected by scrolling to "Digital Audio", press [D] and then [▲/▼] to step through the desired digital input source. After finalizing the desired type of Digital Audio input, press [D] and then [▲/▼] again to select the specific Digital Audio input.

The following are the sets of assignable Digital Audio input:

HDMI → HDMI 1, HDMI 2, HDMI 3, HDMI 4

Optical → Optical 1, Optical 2, Optical Fr

Coaxial → Coaxial 1, Coaxial 2

NOTE

An incoming digital signal present at the assigned digital input will always take precedence over the assigned analog audio input, even if both are present. To maintain the analog audio input for the particular Source, select "Off" at the "Digital Audio" setting of the same "Source" menu.

VIDEO

There are four types of video input a particular Source could be assigned. These are HDMI, Comp (Component), S-Vid (S-Video) and Video inputs. A fifth option is "Off" wherein the particular Source is prompted not to select any Video input.

Navigate through the Video input selections by pressing [D] and then [▲/▼] to step through the selections. The following are the sets of assignable Video input:

HDMI → HDMI 1, HDMI 2, HDMI 3, HDMI 4

Component Video → Comp 1

S-Video → S-Vid 1, S-Vid Fr

Video → Video 1, Video 2, Video Front

VIDEO FORMAT CONVERSION

The T 748 is equipped with a Video Format Converter. This allows for a simplified video connection between the T 748 and your TV Monitor when using multiple video formats such as Composite (CVBS), S-Video, and Component (YUV). This format change is accomplished by encoding the analog video signal into a digital signal using a very high quality digital encoder to maintain the best possible picture quality.

Once in digital format, the video input signal could also be available at the other Monitor output jacks including HDMI MONITOR OUT. Thus, you do not have to necessarily assign the video output of a composite video input signal to MONITOR OUT (Composite video). The composite video input signal can be viewed also at HDMI MONITOR OUT at a resolution setting dependent upon your TV/Monitor's resolution capability. Some TV/ Monitors will automatically display the video signal at 480p/576p if they are not capable of displaying 480i/576i.

A/V PRESET

A particular Source can be assigned a stored Preset. The parameters set up in the selected Preset number will be adopted into the particular Source it is assigned (Please refer to the separate section on "A/V Presets Setup" for further understanding of Preset settings).

Scrolling to "A/V Preset" and by pressing [D] and then [▲/▼], a Source could be assigned a Preset number ranging from Preset 1 to 5.

If it is desired not to assign the particular Source a Preset setting, select "None".

SOURCE SETUP (TABLE)

The Source Setup (Table) reflects the settings made in the Source Setup (Normal) menu. All the Source settings are summarized and displayed in tabulated form in the Source Setup (Table).

	Audio	Vid	P	Name
1	A1	H1	H1	- Source 1
2	A2	O2	C1	- Source 2
3	A3	C1	V1	- Source 3
4	A3	C2	V2	- Source 4
5	A2	--	S1	- iPod
6	AF	OF	SF	- Front
7	AM	--	--	- MP
T	--	--	--	- Tuner

(Press ENTER to Disable)

Navigating through the Source Setup (Table) via a combination of [◀/▶] and then [▲/▼] buttons, one will have the benefit of directly changing the settings for "Audio", "Video", "Preset" and "Source Name" without going back to the Source Setup (Normal) menu.

Highlight a particular Source number and then, toggle [ENTER] button to enable or disable said Source number.

iPod SETUP

iPod Setup	
Enabled	: Yes
Auto Connect	: Yes
Menu Timeout	: 30s

The iPod Setup menu allows you to preset the following associated settings when iPod is the selected source.

Enabled: Select "Yes" to enable iPod as a Source or "No" to disable it.

Auto Connect: Select "Yes" to automatically enable and connect the iPod player docked in the linked NAD iPod docking station when Source 5 (the default iPod source allocation in the T 748) is selected. Select "No" if you do not want a docked iPod to be automatically connected.

Menu Timeout: Set the time for the OSD to revert to the "Now Playing" display when the iPod menu has been left idle (no scrolling or navigation being done) for the specified time out time. For the "Now Playing" OSD to be shown, there should be a song paused or being played before going to the iPod menu. You can set the "Menu Timeout" between the range 5s to 60s at 5s increments. If you do not want for the menu to timeout, select "0s".

SPEAKER SETUP

After connecting all ancillary sources and other combinations, the Speaker Setup menu will guide you on how to manage and setup your speakers in order to achieve optimum sound acoustics in your listening environment.

The following are the Speaker Setup Menu sections.

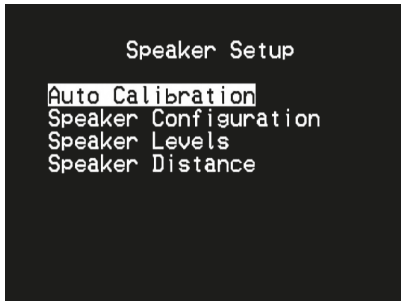
**AUTO CALIBRATION**

It has been shown that many, if not most, surround sound systems are not accurately setup and calibrated. To be done properly, calibration requires special knowledge and instrumentation that the average person probably doesn't possess.

The Auto Calibration featured in T 748 uses a microphone, along with sophisticated digital electronics built into your T 748, to automatically setup and calibrate the T 748 to the exact speakers and speaker placement of your own unique Home Theatre.

The following parameters are automatically measured and adjusted accordingly.

- **Noise Level:** Check noise level relative to each speaker and subwoofer.
- **Number of Speakers:** Speaker configuration is detected including number of surround speakers and whether a subwoofer and center channel is connected.
- **Speaker Distance:** Accurately set the appropriate distance of each speaker position as well as the subwoofer with respect to the microphone position.
- **Speaker Level and Size:** T 748 crossover is set based on each channel's signal handling capability and the subwoofer crossover is automatically set. SPL (Sound Pressure Level) of each speaker is matched with respect to the microphone position.
- **Equalization:** Adjust tonal quality (bass/treble level) for each speaker. This applies to all sound fields and for each speaker.

This is a one-time set up, unless speakers are moved or changed, in which case the calibration should be performed again.

MEASUREMENT IS THE FIRST STEP.

Connect the microphone jack into the front panel's MP/MIC input. Place the supplied microphone in the listening position at about the same height as your listening ears. The microphone has a threaded insert at its base that makes possible for it to be mounted on a tripod.



The sound at your main listening position is setup using the supplied microphone. Depending upon the availability of speakers, you can select either 7.1 or 5.1 setup. Upon selection of either 7.1 or 5.1, the auto calibration starts – refer to the OSD as auto calibration steps through each measurement parameter.

A special test tone is sent to each speaker and the data is memorized by the T 748. The duration of setup may take some time depending on the number of speakers. After the measurements, the T 748 calculates the ideal system response for your particular room and speaker setup. If some inconsistencies or discrepancies are detected during the setup, the process maybe interrupted or the problem is shown in the particular setup window. A notice screen is correspondingly displayed. After following and undertaking the displayed instructions, re-start the Auto Calibration setup again. When the measurements are finalized, the ideal system response is calculated for your particular room and speaker setup.

NOTES

- *Auto calibration is possible only for a 7.1 or 5.1 speaker configuration. For other speaker configurations, like a 2.1 setup, you have to manually set them up by referring to the guidelines below for Speaker Configuration, Speaker Distance and Speaker Levels.*
- *The test tone emitted during measurement is loud. This maybe bothersome for you and may affect as well your other household members and even your neighbor.*

ABOUT EQUALIZATION

Equalization is one of the parameters automatically adjusted when the Auto Calibration feature is initiated. If after Auto Calibration, the resulting equalization effect does not suit your taste or preference, you have the option to turn off such equalization effect. Below is the procedure on how to turn off equalization.

- 1 Ensure that auto calibration is completed. Equalization cannot be turned ON or OFF if auto calibration is not performed and completed.
- 2 Using the AVR 4 remote control and with Device Selector set to AMP page, direct the AVR 4 to the T 748's remote sensor.
- 3 Press and hold AVR 4's [EQ] button until the upper line of the VFD shows "Adjusting EQ" and the lower line "OFF"; equalization is now turned OFF.
- 4 If you decide to turn ON again the calibrated equalization effect, press and hold AVR 4's [EQ] button until the upper line of the VFD shows "Adjusting EQ" and the lower line "ON"; equalization is now turned back ON.

It is recommended that you take full advantage of the T 748's Auto Calibration feature for your speaker setup. However, if you desire to setup your speakers manually or if you already had Auto Calibration but would like to make adjustments, Speaker Configuration, Speaker Levels and Speaker Distance can be manually set up via their respective setup menu.

OPERATION

USING THE T 748 – SETUP MENU

SPEAKER CONFIGURATION

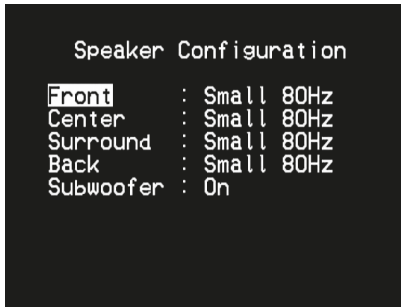

Every surround-sound system requires “bass-management” to direct low-frequency content from any or all channels to the speakers best able to reproduce it. For this function to operate correctly, it is important that you correctly identify your speakers’ capabilities. We use the terms “Small” and “Large” (and “Off”) but note that physical size may be irrelevant.

- A “Small” speaker is any model, regardless of physical size, that lacks significant deep-bass response, that is, below about 150 Hz.
- A “Large” speaker is any full-range model; that is, one with deep-bass response
- An “None” speaker is one that is not present in your system. For example, you might not have any surround-back speakers installed; in that case, you would set the “Back” setup item to “None”.

The Speaker Configuration is “global”; that is, it remains in force with all inputs and in all listening modes. However, speaker settings are part of the T 748’s A/V Preset system. Consequently, multiple speaker settings can be stored for easy recall as different types of recordings or listening modes require.

Speaker Configuration can be managed and adjusted by pressing a combination of [**▶**] and then [**▲/▼**] keys. Set “Front”, “Center”, “Surround” and “Back” to “Large”, “Small” (“Small 60Hz” up to “Small 150Hz”) or “None” as your subsystem’s speakers require.

Set “Subwoofer” to “On” or “Off”, selecting “On” only if you have a subwoofer connected to the T 748’s SUBW output jack. If the “Subwoofer” is set to “Off”, “Front” speaker will automatically be set to “Large”.

ENHANCED BASS

When the subwoofer is set to “On” and “Front” is set to “Large”, Enhanced Bass becomes available. Normally, with speakers set to “Large” the subwoofer is not active. The Enhanced Bass option allows full range operation of the speakers with the additional bass contribution of the subwoofer. This feature is particularly useful when one wants to experience maximum bass output. Please note that due to acoustic cancellation effects, the bass response may be uneven when using this setting

You can set Subwoofer to “On” even with “Large” front speakers, in which case bass content from any channels set to “Small” will be routed to both the subwoofer and to the front speakers; LFE-channel signal will pass only to the sub. In most subwoofer-equipped systems, setting front speakers to “Small” is usually the better option.

All the speakers’ low frequency content can be directly adjusted within the range 60Hz to 150Hz.

NOTE

The configurations set forth at “Speaker Setup” are carried over whenever it is enabled during A/V Presets setting. Please see also the section “AV Presets Setup” for reference.

SPEAKER LEVELS



Adjusting the relative balance of your system’s loudspeakers ensures that surround-sound recordings, whether music or film, will present the balance of effects, music, and dialog that the artists intended. Additionally, if your system incorporates a subwoofer, it establishes a correct relationship between the volume of the subwoofer and the other speakers, and thus of low-frequencies (bass) to other sonic elements.

USING AN SPL METER

It is quite practical to perform the T 748 level setup routines “by ear,” and careful work will produce acceptably accurate results. However, the use of an inexpensive sound-pressure level (SPL) meter, such as Radio Shack part number 33-2050, makes this task easier, more accurate and more repeatable. Ownership of such a meter could prove a valuable audio tool.

The SPL meter should be placed at the primary listening position, at approximately the height of the seated listener’s head. A tripod is helpful but with a little duct tape almost anything - a pole lamp, music-stand, or ladder-backed chair, for example - can do as well. Just be sure that no large acoustically reflective surfaces obstruct or are near the microphone element.

Orient the meter with its microphone (usually at one end) pointing straight up toward the ceiling (not toward the speakers) and ensure that “C” weighting scale is selected. Set the meter to display 75 dB SPL. On Radio Shack meters, this necessitates either setting the meter to its 80 dB range and taking your readings at the -5 point or selecting the 70 dB range and reading at the +5 point.

SETTING SPEAKER LEVELS AT TEST MODE

While at “Speaker Levels” menu, press the AVR 4 remote’s [TEST] key activating the T 748’s Speaker Levels balancing test signal. You will hear a “surf” sound as the test mode cycles through the speakers (“test” appears to the right side of the current speaker), beginning with the Front Left. If you do not hear the test signal, check your speaker connections or your “Speaker Configuration” OSD menu settings.

Use the remote’s [**▲/▼**] keys to adjust the loudness of the noise output from the currently playing channel to the required level (it’s usually simplest to begin with the Front Left). As the test signal cycles around the speakers, the OSD will highlight the currently playing channel. The “level offset” reading on the right will change by 1 dB increments; ±12 dB adjustment is available. Press [ENTER] to adjust the next speaker or for the Test mode to continue on with the other speakers in sequence.

NOTE

If you are balancing levels “by ear”, choose one speaker - usually the center - as a reference and adjust each of the others in turn to “sound as loud” as the reference. Be sure that you remain in the primary listening position while balancing all channels.

To produce the same SPL meter reading (or subjective loudness), use the remote's [▲/▼] keys to adjust each speaker.

You can exit "Test" mode at any time by pressing [■] key, bringing you back to "Speaker Setup" menu. You can also press the [TEST] key to discontinue the "Test" mode.

NOTES

- All speakers must be in their final locations before level-setting.
- Your subwoofer (if any) should be set with its integral crossover defeated, or if undefeatable, set to its highest-possible frequency if you are using the T 748's Subwoofer output. Final subwoofer-level adjustment "by-ear," using music and film sound material, is frequently useful.
- Due to the effects of room acoustics, matched-pair speakers (front; surround; back) will not always calibrate to exactly the same level offset readings.

SPEAKER DISTANCE



Your system's speaker distance settings are a subtle but important refinement of your setup. Informing the T 748 of the loudspeaker-to-listener dimensions of each speaker automatically imposes the correct delays, optimizing imaging, intelligibility and surround-sound ambience. Enter your dimensions with precision within about 1 foot (30 cm).

SETTING SPEAKER DISTANCE

While at "Speaker Distance" menu, use the [▲/▼] keys to individually set Front Left, Center, Front Right, Surround Right, Back Right, Back Left, Surround Left and Subwoofer to the distance measuring from your principal listening position to the front surface of their corresponding loudspeakers. Distance can be set up to 30 feet or 9.0 meters. Distance can be displayed as feet or meters selectable at the "Unit of Measure" item.

ADJUSTING THE VOLUME



In addition to the Volume knob, use the AVR 4's VOL [▲/▼] to adjust the "master volume" of the T 748 raising or lowering the channels altogether. A momentary keypress will change the master volume by 1 dB increments. If you hold down VOL [▲/▼], the master-volume change will "run-on" until the key is released.

Since recordings vary considerably in overall average level, there is no imperative to listen at any particular master-volume setting. A setting of -20dB may sound "as loud" from one CD or DVD as -10dB does from another.

The T 748 will power-up from Standby mode at whatever master volume setting was last used; however, if the prior setting was greater than -20dB, the T 748 will power up at -20dB. This prevents inadvertently beginning a session at excessive volume.

MUTING THE SOUND

Use the AVR 4's [MUTE] key to silence all channels completely. Muting is always available regardless of the source or listening mode selections.

NOTES

- Changing input or listening-mode selections does not release muting.
- Adjusting the volume level via the AVR 4 or the front panel volume knob will automatically release the mute function.

AMPLIFIER SETUP



If the surround back speakers are not used in the main zone, their surround back amplifier channels could be assigned for Main Back, Main Front or Zone 2.

The Surround Back amplifier is configurable through the following settings

- **Main Back:** Assign as surround back speakers.
- **Main Front:** Provide a bi-amp mode for the Main Front speakers (Left and Right) speakers thus reproducing the Front Left and Front Right amplifier channel outputs.
- **Zone 2:** Assign the surround back amplifier channels to supply Zone 2 speaker level output via the surround back speaker terminals. With "Back Amp" set to "Zone 2", playback in the Main zone is reduced to 5.1 channels. Refer also to the item about "ZONE 2 AT AUDIO PRE-OUT SURROUND BACK" in the "ZONE 2 CONTROLS" segment of the "OPERATION - USING THE T 748 - MAIN MENU" section.

HDMI SETUP

The T 748 supports HDMI Control and Audio Return Channel (ARC) functions. Both functions are possible if external devices that also support both features are interconnected to the T 748 via HDMI connection.



CONTROL (CEC)

Consumer Electronics Control (CEC) is a set of commands that utilizes HDMI's two-way communication to allow for single remote control of any CEC-enabled devices connected with HDMI. A CEC command will trigger the necessary commands over HDMI for an entire system to auto-configure itself to respond to the command.

OPERATION

USING THE T 748 – SETUP MENU

When devices that support HDMI Control (CEC) are connected, the following modes of operation can be executed via the T 748 or the external device using any of the device's remote control.

Source (On/Off): At "On" setting, the T 748 will automatically switch sources if another CEC device requests a Source change.

For example, if PLAY is pressed on a BD Player with CEC, the T 748 and TV with CEC will automatically switch to their respective input connections – the T 748 switching to the HDMI input where the BD Player is connected while the TV will switch to its input where the T 748's HDMI MONITOR OUT is connected. This completes the auto-configuration – the BD Player is automatically played back using the T 748 and TV.

Power (On/Off): At "On" setting, the T 748 will automatically go to standby mode if it receives a CEC standby command. On the other hand, if the T 748 receives a CEC power up command, the T 748 will correspondingly switch ON from standby mode.

Volume (On/Off): At "On" setting, the T 748 will respond to CEC volume and mute commands.

For the above Control modes, the T 748 will not respond to any CEC command if the particular mode is set to "Off".

HDMI AUDIO OUT

Amp: HDMI Audio stream is sent to the T 748. Audio output is manifested through the T 748's speakers.

TV: HDMI Audio stream is sent to the TV. Audio output is manifested through the TV's speakers.

HDMI ARC

HDMI ARC stands for HDMI Audio Return Channel. HDMI ARC function enables an HDMI-ARC compatible TV to send audio data stream to the T 748. Audio output is manifested through the T 748's speakers.





- HDMI ARC is enabled only with "Volume" setting set to "On". If "Volume" is set to "Off", HDMI ARC is automatically set to "Off".
- "HDMI ARC" is shown in the VFD when it is set to "On" and active.

IMPORTANT NOTES

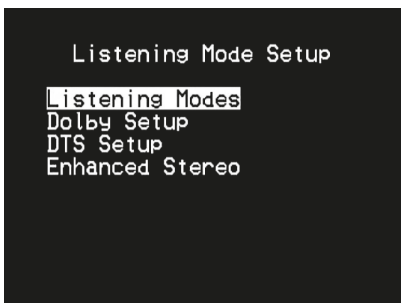
- *The CEC or HDMI ARC response among the devices may vary or may not be achieved as expected. This may depend upon the other devices' setup configuration, compatibility or capability.*
- *Audio and video will continuously stream from the HDMI source with CEC to the TV with CEC even if the T 748 is at standby mode.*

LISTENING MODE SETUP



The T 748 has various listening mode options and is mostly configurable. These are provided to reproduce a variety of sound effects depending upon the content of the source to be played. Use a combination of [ /  /  / ] to configure the following settings.

LISTENING MODES

The audio format as detected by the selected Source can be automatically configured and processed through the following options:



DOLBY DIGITAL

Dolby Digital is the multi-channel digital signal format developed in the Dolby laboratories. Discs bearing the Dolby Digital (double-D symbol) logo were recorded with up to 5.1 channels of digital signals, reproducing a much better sound quality, with dynamic and spatial sound sensations that are much better than in the previous Dolby Surround.

A Dolby Digital audio input can be configured relative to its format as follows

Stereo: If the detected audio is of Dolby stereo format, you can default it to one of the following settings - Stereo, PLIIx Movie, PLIIx Music, PLIIx Game, Neo:6 Cinema or Neo:6 Music.

Surround: If the detected audio is of Dolby Surround format, you can default it to one of the following settings - Stereo, PLIIx Movie, PLIIx Music, Dolby D Ex, Neo:6 Cinema or None.

None: If "None" is selected, the Dolby Digital signal will be defaulted to the "Stereo" or "Surround" settings set forth at the "PCM" option. See discussion below about "PCM".

DOLBY DIGITAL SURROUND MODES

The following are further descriptions of Dolby Digital surround modes.

DOLBY DIGITAL PLUS

Dolby Digital Plus is the next-generation audio technology for all high-definition programming and media. It combines the efficiency to meet future broadcast demands with the power and flexibility to realize the full audio potential expected in the upcoming high-definition era. Built on Dolby Digital, the multi-channel audio standard for DVD and HD broadcasts worldwide, Dolby Digital Plus was designed for the next-generation A/V receivers but remains fully compatible with all current A/V receivers.

Dolby Digital Plus delivers multi-channel audio programs of up to 7.1 channels and supports multiple programs in a single encoded bitstream with the maximum bit rate potential of up to 6 Mbps and the maximum bit rate performance of up to 3 Mbps on HD DVD and 1.7 Mbps on Blu-ray Disc. It outputs Dolby Digital bitstreams for playback on existing Dolby Digital systems. Dolby Digital Plus can accurately reproduce the sound originally intended by directors and producers.

It also features multi-channel sound with discrete channel output, interactive mixing and streaming capability in advanced systems. Supported by High-Definition Media Interface (HDMI), a single-cable digital connection is possible for high-definition audio and video.

DOLBY TrueHD

Dolby TrueHD is a lossless encoding technology developed for high-definition optical discs in the upcoming era. Dolby TrueHD delivers tantalizing sound that is bit-for-bit identical to the studio master, unlocking the true high-definition entertainment experience on high-definition optical discs in the next generation. When coupled with high-definition video, Dolby TrueHD offers an unprecedented home theater experience with stunning sound and high-definition picture.

It supports bit rates of up to 18 Mbps and records up to 8 full-range channels individually with 24-bit/96 kHz audio. It also features extensive metadata including dialogue normalization and dynamic range control. Supported by High-Definition Media Interface (HDMI), a single-cable digital connection is possible for high-definition audio and video. HD DVD and Blu-ray Disc standards currently limit their maximum number of audio channels to eight, whereas Dolby Digital Plus and Dolby TrueHD support more than eight audio channels. Note that the T 748 only supports 7.1 channel.

DOLBY DIGITAL EX

Using a Matrix decoder, this method creates the back channel (sometimes also called the “surround center”) by means of signals on the left and right surround channels recorded in Dolby Digital 5.1, reproduction being provided in Surround 6.1. This method should be selected with sources bearing the “Dolby Digital (double-D symbol)-EX” symbol, recorded in Dolby Digital Surround EX.

With this additional channel you will experience improved dynamics and a better sensation of movement within the sound field. If media sources recorded in Dolby Digital EX are decoded with a Digital EX decoder, the format is detected automatically, and the Dolby Digital EX mode is selected. However, some media sources recorded in Dolby Digital EX can be detected as simple Dolby Digital media sources. In this case Dolby Digital EX should be selected manually.

NOTE

Please refer to the section “Listening Mode” at the Main Menu discussions for a description of Pro Logic, PLIIx Movie, PLIIx Music and Stereo Downmix modes.

DTS

The Digital Theater System Digital Surround (simply called DTS) is a multi-channel digital signal format that can process higher data rates than with Dolby Digital. Although both Dolby Digital and DTS are 5.1 channel media formats, discs bearing the “DTS” symbol are thought to provide better sound quality due to the lower audio compression required. It also offers a broader dynamic, producing magnificent sound quality.

A DTS audio input can be configured relative to its format as follows

Stereo: If the detected audio is of Dolby stereo format, you can default it to one of the following settings - Stereo, PLIIx Movie, PLIIx Music, PLIIx Game, Neo:6 Cinema or Neo:6 Music.

Surround: If the detected audio is of DTS Surround format, you can default it to one of the following settings - Stereo, PLIIx Movie, PLIIx Music, Neo:6 Cinema, Neo:6 Music or None.

None: If “None” is selected, the DTS signal will be defaulted to the “Stereo” or “Surround” settings set forth at the “PCM” option. See discussion below about ‘PCM’.

NOTE

Please refer to the section “Listening Mode” at the Main Menu discussions for a description of Stereo Downmix and DTS NEO:6 surround modes.

PCM

PCM (Pulse Code Modulation) is the digital representation of a standard audio signal converted with little or no compression. If “None” is selected for any of the Dolby or DTS settings, this “PCM” section will default the audio signal as follows

Stereo: The detected stereo audio format will be configured into one of the following options - PLIIx Movie, PLIIx Music, PLIIx Game, Neo:6 Cinema, Neo:6 Music EARS or Enhanced Stereo.

Surround: The detected surround audio format will be configured into one of the following options - PLIIx Movie, PLIIx Music, Neo:6 Cinema, Stereo or None.

ANALOG

If the audio input is an analog signal, the following are the surround modes the input can be defaulted - Pro Logic, PLIIx Movie, PLIIx Music, NEO:6 Cinema, NEO:6 Music, EARS, Enhanced Stereo, Analog Bypass and None.

NOTE

All these Listening Modes for Dolby Digital, DTS, PCM and Analog can be directly changed by pressing the “Listening Mode” button on the front panel or through the “Listening Mode” option at the Main Menu window. The chosen audio format will be reflected back to the appropriate setting at the “Listening Mode Setup”.

DOLBY SETUP

Under this menu, the Dolby Digital’s Dynamic Range Control can be adjusted as well as the settings for Dolby Digital Pro Logic IIx Music.

Dyn Range Ctrl: You can select the effective dynamic range (subjective range from soft to loud) for playback of Dolby Digital soundtracks. For fully cinematic effect, always select “100”, the default. Settings of 75, 50 and 25% progressively reduce dynamic range, making soft sounds comparatively louder while limiting the peak loudness of loud ones.

The 25 setting will yield the least dynamic range and is best for late-night sessions or other times when you wish to retain maximum dialog intelligibility while minimizing overall volume levels.

Dolby Pro Logic IIx Music: Please refer to the same description of “PLIIx Music” under the “ADJUSTING LISTENING MODES” segment of the “OPERATION - USING THE T 748 - MAIN MENU”.

OPERATION

USING THE T 748 – SETUP MENU

DTS SETUP

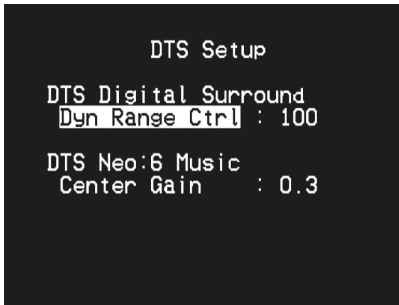

Under this menu, the Dynamic Range Control of DTS Digital Surround can be adjusted as well as the settings for DTS Neo: 6 Music.

Dyn Range Ctrl: This is the same configurable Dynamic Range Control feature as described above at Dolby Setup, the only difference being the soundtrack is now in DTS format.

DTS Neo: 6 Music: Please refer to the same description of "NEO 6: Music" under the "ADJUSTING LISTENING MODES" segment of the "OPERATION - USING THE T 748 - MAIN MENU".

DTS SURROUND MODES

The following are further descriptions of DTS surround modes.

DTS-HD MASTER AUDIO

DTS-HD Master Audio is a technology that delivers master audio sources recorded in a professional studio to listeners without any loss of data, preserving audio quality. DTS-HD Master Audio adopts variable data transfer rates, facilitating data transfer to the maximum rate of 24.5 Mbps in the Blu-ray disc format, 18.0 Mbps in the HD-DVD format, which by far exceeds that of a standard DVD. These high data transfer rates enable lossless transmission of 96 kHz/24-bit 7.1-channel audio sources without deteriorating the quality of the original sound. DTS-HD Master Audio is an irreplaceable technology that can reproduce sound faithfully as intended by the creator of music or movies.

DTS-ES EXTENDED SURROUND (DTS ES)

This is a new multi-channel digital format which greatly improves the 360 degrees spatial sensation of the Surround impression thanks to the greater space expansion of the surround signals, providing high compatibility with the conventional DTS format.

In addition to the 5.1 channels, the expanded DTS-ES Surround also offers the back surround (also sometimes called the "surround centre") in reproduction, providing a total of 6.1 channels. The expanded DTS-ES Surround includes two formats, with two different methods of surround signal recording, as follows:

DTS-ES DISCRETE 6.1

Since the signals of the 6.1 Surround channels (including the back channel) are completely independent, it is possible to achieve the sensation that the acoustic image is moving about freely among the background sounds, 360 degrees surrounding the listener.

Although maximum quality is achieved with sound tracks recorded using this system and reproduced using the DTS-ES decoder, when played with a conventional DTS decoder, the back surround channel is automatically downmixed in the surround right and surround left channels of the surround system, in such a way that none of the signal components are lost.

DTS-ES MATRIX 6.1

In this format, the additional signals of the back channel receive a matrix encoding and are inputted into the right and left surround channels. During reproduction they are decoded to the right, left and back surround channels.

Since this bit-stream format is 100% compatible with conventional DTS signals, the DTS-ES Matrix 6.1 format effect can also be achieved from sources with DTS-ES 5.1 signals.

Naturally, it is also possible to reproduce from a DTS 5.1 channel decoder, signals recorded in DTS-ES 6.1.

When a DTS-ES decoder processes a discrete DTS-ES 6.1 or in Matrix 6.1, these formats are automatically detected and the Optimum Surround mode is selected. However, some DTS-ES Matrix 6.1 sources may be detected as DTS. In this case the DTS-ES Matrix mode should be selected manually in order to reproduce them.

DTS NEO: 6 SURROUND

This mode applies the conventional 2-channel signals such as digital PCM or analog stereo signals to the high precision digital matrix decoder used for DTS-ES Matrix 6.1 to achieve 6.1-channel surround playback. DTS Neo: 6 surround includes two modes for selecting the optimum decoding of the signal sources:

DTS NEO: 6 CINEMA: This method is ideal for the reproduction of movies. The decoding takes place by emphasizing the separation in order to achieve the same atmosphere with 2-channel, as with 6.1-channel sources.

DTS NEO: 6 MUSIC: Mainly recommended for music reproduction. The right and left front channels do not pass through the decoder and are reproduced directly so there is no loss in sound quality, and the effects of the right surround, left surround, central and back surround channels add a natural sensation of expansion of the sound field.

ENHANCED STEREO

Please refer to the same description of ENHANCED STEREO under the LISTENING MODES segment of the OPERATION - USING THE T 748 - MAIN MENU.

DISPLAY SETUP



The Vacuum Fluorescent Display (VFD) and On-Screen Display (OSD) can be shown in various ways by navigating through the parameters at the Display Setup menu. Use a combination of [**▲**/**▼**] keys to step through the Display Setup menu items.

NOTE

The configurations set forth at "Display Setup" are carried over whenever it is enabled during A/V Presets setting. Please see also the section below about "AV Presets Setup".

VACUUM FLUORESCENT DISPLAY (VFD)

Display: Select "On" to display all applicable data or characters at the VFD. Nothing will be shown at VFD if "Off" is selected. At "Off" setting however, whenever any of the front panel controls or their corresponding keys in the remote control is activated, the appropriate VFD characters will be shown temporarily and then fade away.

Dimmer: If it is desired to reduce the brightness of the VFD, set Dimmer to "Dim". Otherwise, select "Bright" to return to normal VFD brightness.

Line 1, Line 2: The VFD shows two main lines of data or characters. Line 2 is the line of data or characters located at the lower bottom of the VFD while directly above it is Line 1. For both lines, one can select which display could be shown by choosing through the following

Source: Shows the active Source.

Volume: Current Volume level is shown.

Listening Md: Selected Listening Mode is shown.

A. Src Format: Shows the active Source's detected audio format.

Off: Select "Off" if it is desired not to show any data at the applicable Line.

Temp Line: Choose between Line 1 and Line 2 as the desired line where VFD will be temporarily shown if "Off" is selected at "Display" option as described above.

A/V PRESETS SETUP



The T 748's simple but powerfully flexible system of "A/V Presets" allows you to customize virtually every aspect of your audio-video playback, and recall them with a single key-press. The parameters "Listening Mode", "DSP Option" and "Tone Controls" accessible via the "Main Menu" together with "Speaker Setup" and "Display Setup" configurable through "Setup Menu" are stored together as a single A/V Preset.

You might create one A/V Preset optimized for pop music and another for classical. One more A/V Preset can be set up to recall each family member's favorite setting or one for fully cinematic home-theater playback and yet another one for late-night movies, with each A/V Preset fine-tuned to a particular scenario or preference.

CREATING PRESETS

Creating an A/V Preset consists simply of storing a complete set of the parameters set forth in "Listening Mode", "DSP Option" and "Tone Controls" accessible via the "Main Menu" together with "Speaker Setup" and "Display Setup" configurable through "Setup Menu".

Scroll to "A/V Presets Setup" using the [**▲**/**▼**] keys to save a collection of said parameter settings to a Preset. Select a Preset number and by pressing the [**▲**/**▼**] keys, you can selectively include in the particular A/V Preset any of the above-mentioned parameter settings by choosing "Yes". If you decide not to include in the particular A/V Preset a certain parameter setting, select "No".

Now in order to save the settings chosen for the particular A/V Preset number, scroll down to "Save Settings to Setup" and press the [**▶**] key. If you chose to load instead the default settings, scroll down to "Load Defaults to Preset" and press the [**▶**] key to restore the default settings.

In addition to the parameter settings, the A/V Preset label itself can be assigned a new name. This new Name will be shown in the VFD as well as on the OSD.

To rename the A/V Preset label, scroll to "Name" and press [**▶**] to go the first character. Then, press [**▲**/**▼**] to pick and select through the alphanumeric selections. Press [**◀**/**▶**] to move to the next character or back to the previous character and at the same time save the changes done on the current character. An A/V Preset can be renamed up to 8 characters.

NOTE

The selected A/V Preset remains in force until you select a different A/V Preset.

OPERATION

USING THE T 748 – SETUP MENU

SAMPLE PROCEDURE FOR SETTING UP A/V PRESETS

- 1 Setup first your preferred settings for the following options (access them through their respective menu page).

Listening Mode: Stereo



DSP Option: 5ms



Tone Controls: Tone Defeat: On

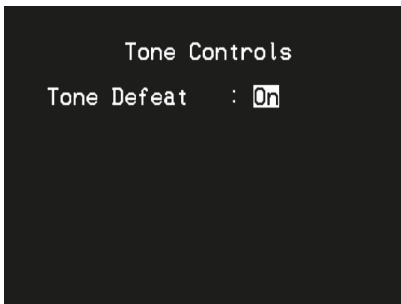

Display Setup: Set "Line 2" to "Listening Mode"

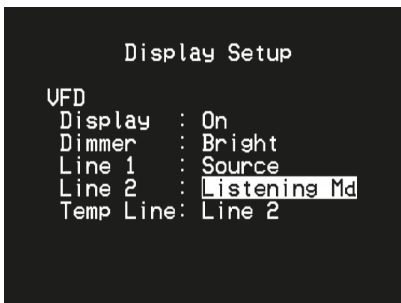

Speaker Setup: from the Speaker Setup menu, go to "Speaker Configuration" sub-menu and change "Subwoofer" from "On" to "Off": "Front" becomes "Large"

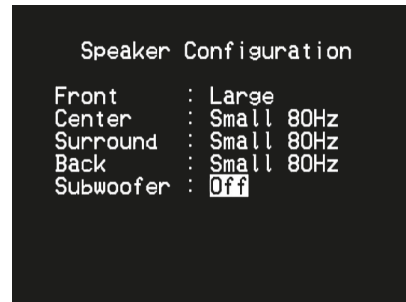
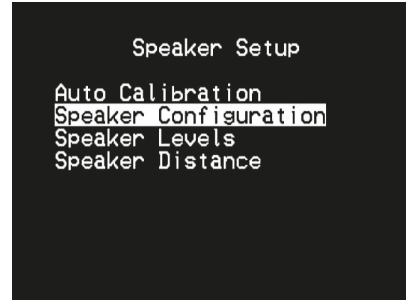

- 2 With the above settings, scroll to "A/V Presets Setup" from the SETUP MENU page. Use [] to access "A/V Presets Setup" menu.

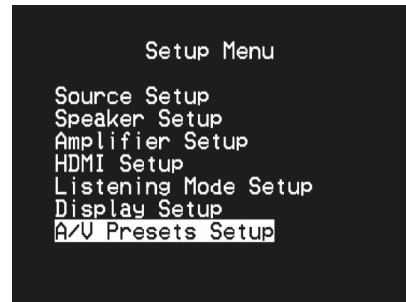

- 3 At "A/V Presets" page, set "Preset: 1" to the following conditions as below. Use [] to select "Yes" or "No". Then, press [], [] and [] to exit a line item and move on to the next setting.



While at "Save Settings to Setup" menu line, use [**▶**] to save the above settings to Preset 1. Below OSD will be shown, affirming that the above settings are now saved to "Preset 1".



When associated to a particular Source number, the above preset values and settings allocated at "Preset 1" (preset settings as shown in the OSD captures at Step 1) will be recalled and applied to said assigned source.

- Now, repeat again Step 1 above but this time with the following settings

Listening Mode: PLIIx Music

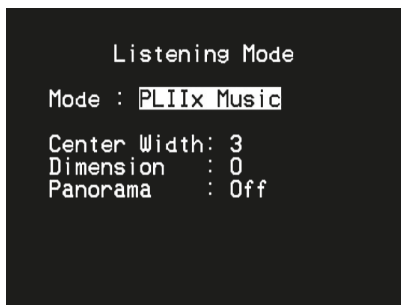

DSP Options: 0ms



Tone Controls: Tone Defeat: Off



Display Setup: Set "Line 2" to "Volume"

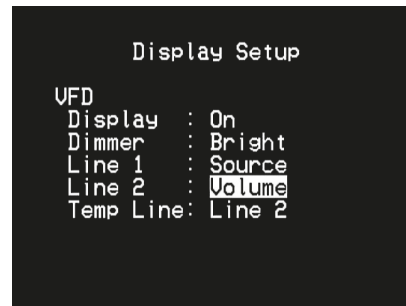

- With the above settings, scroll to "A/V Presets Setup" from the SETUP MENU page. Use [**▶**] to access "A/V Presets Setup" menu.

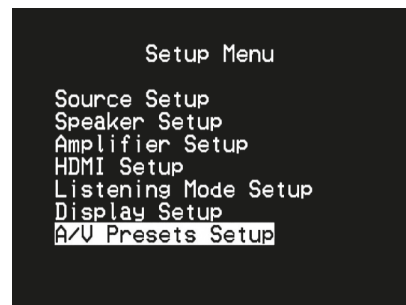

- At "A/V Presets Setup" page, set "Preset: 2" to the following conditions as below. Use [**▲/▼**] to select "Yes" or "No". Then, press [**◀**], [**▼**] and [**▶**] to exit a line item and move on to the next setting.



While at "Save Settings to Setup" menu line, use [**▶**] to save the settings above to "Preset 2". When associated to a particular Source number, the above preset values and settings allocated at "Preset 2" (preset settings as shown in the OSD captures at Step 4) will be recalled and applied to said assigned source.

Note that "Speaker Setup" is set to "No". At this condition, there will be no "Speaker Setup" settings that will be associated to "Preset 2". The "Speaker Setup" settings that will be applied to "Preset 2" will be the last or current "Speaker Setup" settings which in this sample are the same "Speaker Setup" settings shown above in Step 1.

OPERATION

USING THE T 748 – SETUP MENU

- 7 You can setup up to 5 A/V Presets. These same A/V Presets can also be associated/defaulted to each Source in the "Source Setup (Normal)" window as below.

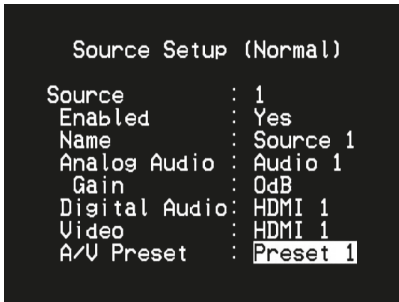

In the above example, "Preset 1" settings are allocated to Source 1. Whenever Source 1 is accessed, the "Preset 1" settings will be applied to Source 1.

AUTO POWER DOWN SETUP

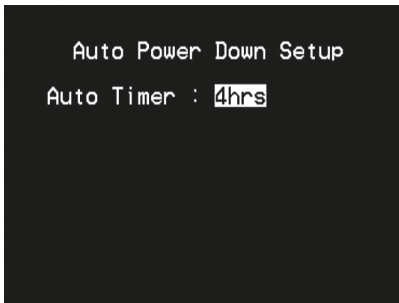

The T 748 can be setup to automatically go to standby mode if there is no user interface interaction within the allocated time. Set "Auto Timer" to preferred time.

4hrs, 8hrs, 30mins: Set time to allow the T 748 go to standby mode automatically in the absence of any user interface interaction.

Off: The T 748 remains active even though no user interface interaction is detected.

The T 748's internal AM/FM tuner offers very high quality sound from radio broadcasts. The reception and sound quality will always be dependent to a degree however on the type of antenna(s) used as well as proximity to the broadcast origin, geography and weather conditions.

ABOUT ANTENNAS

Connect the supplied lead-type FM antenna to the FM antenna input. Extend the lead. Experiment freely with your antenna placement and orientation until you get the clearest sound and lowest background noise. Fix the antenna in the desired position by using thumb tacks, push pins or any suitable means.

In areas of poor FM reception, an exterior FM antenna can improve performance dramatically. If radio listening is important to you, consider consulting an antenna installation professional to optimize your system.

The supplied AM "loop" antenna will usually provide adequate reception. However, an exterior AM antenna can be used to improve reception. Consult an antenna professional for more information.

IMPORTANT NOTE

When using the AVR 4 to carry out AM/FM commands, ensure that the DEVICE SELECTOR is set to "TUN".

ASSEMBLING THE LOOP ANTENNA

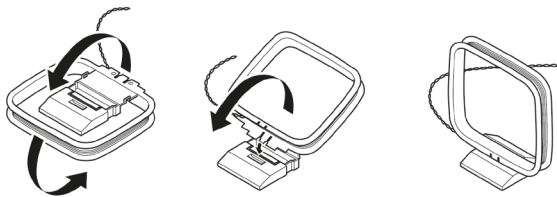

- 1 Rotate the outer frame of the antenna.
- 2 Insert the bottom edge of the outer frame into the groove on the stand.
- 3 Extend the antenna cord.

SELECTING A TUNER BAND

Press the [AM/FM/DB] button on the AVR 4 while at AMP or TUNER device selector page. Each subsequent press will toggle you through AM, FM or DAB band. Stop (release button) at your desired tuner band.

TUNING AM/FM STATIONS

Upon selecting AM or FM band, use TUNE [◀/▶] on the AVR 4 to perform slow manual search; press and hold to automatically search.

The front panel [◀/▶] or AVR 4's [◀/▶] buttons can also be used to tune for stations.

- 1 Press [◀/▶] momentarily to step up or down between AM or FM frequencies.
- 2 Press and hold [◀/▶] for more than 2 seconds to search up or down - the T 748's tuner will stop at the next sufficiently strong signal it encounters.
- 3 Pressing the [◀/▶] during the search process will stop the search.

DIRECT TUNING

If you know your desired station's frequency allocation, you can tune directly to the station.

- 1 Toggle [ENTER] button to switch between "Preset" and "Tune" mode (see the lower line of the VFD). Select "Tune" mode.
- 2 Using the numeric keys of the remote control, key-in the frequency allocation of the station. For example, to enter 104.50MHz, press "1", "0", "4", "5" and "0".

STORING PRESETS (AM/FM)

The T 748 can store up to 30 FM and 30 AM stations for immediate recall.

- 1 To store a desired AM/FM station to a preset, first tune to the desired frequency (see above), then press AVR 4's [MEMORY] button. The VFD will show the next available Preset number - for example, "Preset 4 Free" in the lower line and on the upper right corner "P-4" with "4" blinking.
- 2 Press the [MEMORY] button again to store the desired frequency on the Preset number shown. Your desired frequency is now stored in the assigned preset.
- 3 Alternatively, an AM/FM station can be stored to a Preset number by repeating step 1. Enter a Preset number in two ways
 - Directly enter a number between 1 to 30 and then press [MEMORY] button.
 - Toggle [^/∨] or [▲/▼] to step through the Preset numbers, stop at desired number and then press [MEMORY].

NOTE

If there is no more vacant Preset number, you can overwrite an existing Preset number by pressing the [▲/▼] buttons to select the Preset number you want to overwrite

AUTOMATIC PRESET

Preset stations may also be programmed automatically for the entire FM (or AM) band.

- 1 Toggle the [AM/FM/DB] button to select FM (or AM) band.
- 2 Press and hold the [MEMORY] button until the station frequency indication begins to increase.
- 3 Release the button and note that the tuner will search the entire FM (or AM) band, and stop briefly at each station that has acceptable signal strength. The T 748 will automatically assign a preset number to each station, and then search for the next station. Up to 30 of the best received FM stations (or 30 AM stations) will be automatically stored.

DIRECT RECALL OF A PRESET NUMBER

You can directly recall a desired Preset number.

- 1 Toggle [ENTER] button to switch between "Preset" and "Tune" mode (see the lower line of the VFD). Select "Preset" mode.
- 2 Using the numeric keys of the remote control, directly key-in your desired Preset number. For example, to enter Preset 5, press "5".

DELETING A STORED PRESET

You can empty a preset by deleting the stored information.

- 1 Select the preset number to be deleted.
- 2 While at the selected preset number, press the [DELETE] button.
- 3 The preset will then be deleted. "Delete" is briefly shown in lower line of the VFD.
- 4 To clear all the Presets at the same time, repeat step 2 again but this time do not release the [DELETE] button. Press and hold [DELETE] button until the current Preset number shown in the VFD is extinguished (P--). "Delete All" is briefly shown in lower line of the VFD. All Presets are now deleted.

OPERATION

LISTENING TO AM/FM RADIO

CHOOSING THE TUNER MODE

The AVR 4's [TUNER MODE] key is a dual-purpose control. Toggle [TUNER MODE] to switch between "FM STEREO ON" and "FM STEREO OFF". In the normal position, "FM STEREO ON", only the stations with a strong signal can be listened to, and the noise between stations is muted.

Pressing the [TUNER MODE] button again ("FM STEREO OFF") allows distant and potentially noisy stations to be received. Noise is reduced if the FM station signal level is less than the FM Stereo threshold (since mono FM is inherently less noise-prone) though at the sacrifice of the stereo effect.

ABOUT USER NAMES

A particular Preset number can be assigned an eight-character "User Name". The assigned "User Name" will be shown in the VFD whenever the associated Preset number is recalled.

ENTERING USER NAMES

To assign a Preset number with the user name "NEWS", follow the procedure as below.

- 1 Recall the desired Preset number.
- 2 Then, press and hold [INFO] of the AVR 4 until the display shows a flashing cursor point.
- 3 Use the [▲/▼] buttons to select the first character of the name ("N" from the alphabetical list).
- 4 Press [▶] button to select the character and correspondingly move forward to the next position. (Press [◀] to go back to the previous character). Repeat this process for each character in sequence.
- 5 Press the [INFO] key to store the User Name and exit the text-entry mode.

ABOUT RDS

The Radio Data System (RDS) permits sending small amounts of digital information using conventional FM radio broadcasts. The T 748 supports two RDS modes, program-service name (PS mode) and radio-text (RT mode). Not every FM station incorporates RDS in its broadcast signal. In most areas you will find from one to several RDS-enabled stations, but it is by no means impossible that your favorite stations will not be broadcasting RDS data.

VIEW RDS TEXT

When an RDS-enabled FM broadcast is tuned, the readout's character section will show its program-service name (PS) text.

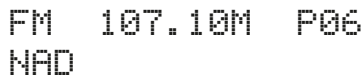

```

FM 107.10M P06
NAD
  
```

Press the AVR 4's [INFO] button to toggle the readout between this and the station's radio-text (RT) readout, if any, which might scroll song- or artist-name, or any other text of the station's choosing.

OPERATION

LISTENING TO DAB RADIO

DAB TUNER MODE

Aside from "Full scan" as already described above, pressing [TUNER MODE] will also present you with other options namely - Local scan, Station order, Dynamic range, Manual tune, Prune list and DAB reset. Use [◀/▶] to step through these options.

An asterisk (*) to the right of a menu option indicates that it is the currently selected option for a particular DAB menu. For example, <Favourites *> means "Favourites" is the selected sequence for the DAB menu "Station order".

```
DAB
<Favourites  *>
```

LOCAL SCAN

LOCAL SCAN performs local scanning of available DAB services in your area. Check with your dealer or visit www.WorldDAB.org to check the applicable digital transmission frequencies in your area.

- 1 While listening to a DAB broadcast, press [TUNER MODE] button and then [◀/▶] to select "Local scan". Press [ENTER].

```
DAB
<Local scan  >
```

- 2 Local scan of available DAB services in your area will start. The arrows show the progress of the sequence. When scanning is completed, the last number shown on the right side of the VFD corresponds to the total number of DAB broadcast stations found. Then, the first station is tuned in.

STATION ORDER

Use "Station order" to sort the sequence of the listed stations. There are four orders – Alphanumeric, Active, Ensemble and Favourites.

- 1 While listening to a DAB broadcast, press [TUNER MODE] button and then [◀/▶] to select "Station order". Press [ENTER].

```
DAB
<Station order >
```

- 2 Toggle [◀/▶] to select through "Alphanumeric", "Active", "Ensemble" and "Favourites".
- 3 Press [ENTER] to select desired station order.

ALPHANUMERIC

This is the default setting. Stations are arranged by numbers first and then alphabetically by letters.

ACTIVE

Active stations are listed at the top of the broadcast list. DAB broadcasts that are in the list but have no service in the area will be displayed last in the broadcast list.

ENSEMBLE

Digital radio is broadcast as groups of data called ensemble. Each ensemble contains a number of stations, transmitted at a set frequency. When "Ensemble" is selected as the mode of station order, the radio stations are arranged in the order of their ensemble names.

NOTE

Ensemble is also interchangeably termed as "multiplex" by other broadcast providers.

FAVOURITES

The T 748 memorizes the top ten stations you listen as you tune in stations. They will be listed at the top of the broadcast list.

DYNAMIC RANGE

The level of compression of stations can be set to eliminate the differences in dynamic range or sound level between DAB broadcasts. Popular music would normally be more compressed than classical music, resulting in possible different audio levels when changing from one station to the other. Setting the Dynamic Range to "D-range 0" means no compression, "D-range 1/2" indicates medium compression and "D-range 1" shows maximum compression. No compression is recommended, especially for classical music.

- 1 While listening to a DAB broadcast, press [TUNER MODE] button and then [◀/▶] to select "Dynamic range". Press [ENTER].

```
DAB
<Dynamic range >
```

- 2 The lower line display shows the current dynamic range setting (with an asterisk). Toggle [◀/▶] to select through "D-range 0", "D-range 1/2" and "D-range 1".

```
DAB
<D-range 0  *>
```

- 3 Press [ENTER] to select desired dynamic range level.

MANUAL TUNE

This option allows you to manually tune to a desired DAB broadcast and include it in the service list (if not yet available at the time). You can also use MANUAL TUNE to assist you in positioning the DAB antenna for best reception of the desired DAB broadcast.

- 1 While listening to a DAB broadcast, press [TUNER MODE] button and then [◀/▶] to select "Manual tune". Press [ENTER]. The current channel and frequency are shown in the lower line of the VFD.

```
DAB
<Manual tune  >
```

- To select other channels, toggle [/] to step through the channel list. Release [/] when you have arrived at your desired channel. Press [ENTER] to tune the selected channel.
 - Channel and frequency are shown in the lower line of the VFD. The number of "o" display at the upper line of the VFD indicates the signal strength level of the current channel. To improve the reception of the selected channel, adjust or reposition the DAB antenna until the best reception is indicated.

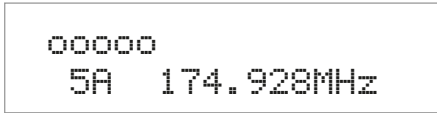

- If the manually tuned channel and frequency are not available, "No Service List" will be shown in VFD.

NOTE

The number of ensembles and stations that could be scanned will vary depending upon your location.

PRUNE LIST

There may be situations wherein certain stations become inactive. The "Prune list" option enables the deletion of these inactive stations in the service list.

- While listening to a DAB broadcast, press [TUNER MODE] button and then [/] to select "Prune list".

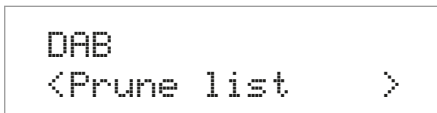

- Press [ENTER]. Use [/] and then press [ENTER] to select between "Cancel" or "OK? [SELECT]". Any inactive stations (normally preceded by a "?" mark) are automatically deleted when "OK? [SELECT]" is selected. Otherwise, select "Cancel".



DAB RESET

The "DAB reset" option enables the re-initializing of the NAD DAB Adaptor by going to Full Scan mode.

- While listening to a DAB broadcast, press [TUNER MODE] button and then [/] to select "DAB reset". Press [ENTER].

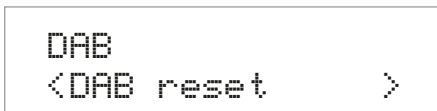

- The T 748 will initiate "DAB reset" and immediately go on to "Full Scan" mode thereby enabling the T 748 to re-scan again the full range of available DAB broadcasts.

IMPORTANT NOTICE

When "DAB reset" option is selected, all stored DAB presets will be erased.

SETTING DAB PRESETS

The T 748 can store as many as 40 DAB stations of your favorite DAB broadcast for immediate recall.

- To store a DAB preset, first tune the DAB broadcast, and then press the AVR 4's panel [MEMORY] button (DEVICE SELECTOR must be set "TUN"). The VFD will show "Preset Memory --," "--" is blinking waiting for a Preset number to be assigned.
- Enter a Preset number in two ways
 - Directly enter a number between 1 to 40 and then press [MEMORY] button.
 - Toggle [/] or [/] to step through the Preset numbers, stop at desired number and then press [MEMORY].
 Your desired DAB broadcast is now stored in the assigned preset.

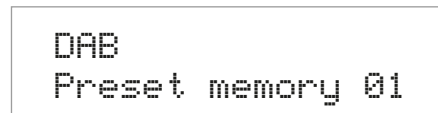

- Press [/] or [/] to step up or down between presets. Stop at desired Preset number. Note that Presets must have been previously stored.

DELETING A DAB PRESET

The procedure for deleting a DAB preset or all DAB Presets is the same as that of deleting AM/FM Presets.

INFORMATION SETTINGS

While listening to a DAB broadcast, the type of information displayed in the lower line of the VFD can be varied. Toggle AVR 4's [INFO] button to step through the following display options:

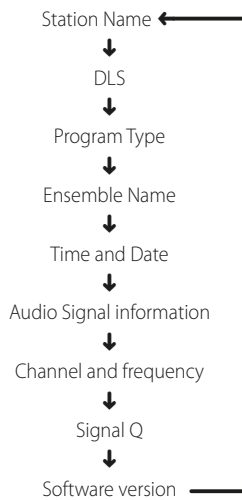

STATION NAME

The name or identification of the DAB broadcast station is shown.

DLS

Dynamic Label Segment (DLS) is the scrolling text supplied by the broadcasting station. It may contain information on music titles or details regarding the program or station.

PROGRAM TYPE

This is a description of the type of broadcast supplied by the station, such as Pop, Rock, Drama and the likes.

ENSEMBLE NAME

Displays the name of the ensemble on which current service is found.

TIME AND DATE

The current time and date as supplied by the DAB station are displayed.

AUDIO SIGNAL INFORMATION

Displays the bit rate and audio type (stereo, mono or joint stereo) as transmitted by the DAB broadcast provider. These are set by the broadcaster to suit the type and quality of material being transmitted.

CHANNEL AND FREQUENCY

The channel and frequency of the currently tuned DAB broadcast are displayed.

SIGNAL QUALITY

This displays the digital error rate (0 to 99) of the currently tuned channel - the lower the figure, the better the quality of the received broadcast.

SOFTWARE VERSION

Show the version number of the installed software.

The T 748 is equipped with a data port in the rear panel where an optional "NAD IPD Dock for iPod" (NAD IPD) can be plugged in. With the NAD IPD linking the T 748 with your own iPod player, you can enjoy listening to your favorite tracks and playlists as well as view applicable still image and video playback.

You can control your iPod player using the assigned buttons in the T 748 front panel. And with the corresponding AVR 4 remote control function keys, you can select the materials stored in your iPod for playback as well as access many of its functions even from across the room. The optional NAD IPD also charges your iPod player while it is connected to the T 748.

NOTES

- "NAD IPD Dock for iPod" (NAD IPD) currently has two versions - the NAD IPD 1 and NAD IPD 2. These two NAD IPD models and later variants are compatible with the T 748.
- NAD IPD and iPod player are not supplied with your T 748.
- iPod player functions, features and playback capabilities accessible through T 748 may vary depending on your iPod player model.
- When using the AVR 4 to control the iPod functions, make sure that the Device Selector is set to "MP."



CONNECTING THE OPTIONAL NAD IPD AND iPod PLAYER TO THE T 748

Make sure that all the devices are unplugged before making the connections.

- 1 Connect the NAD IPD's DATA PORT to the corresponding "MP DOCK" data port of the T 748.
- 2 Connect also the NAD IPD's S-Video out and audio out to the T 748 AUDIO 2/S-VIDEO input (the default iPod source allocation in the T 748).
- 3 Dock your iPod player into the NAD IPD.

NAVIGATING THE IPOD PLAYER'S FUNCTIONS AND FEATURES

After linking together your iPod player, NAD IPD and the T 748, you can now plug them IN to their applicable power sources.

- 1 With your T 748, iPod player and NAD IPD all at power ON state, select SOURCE 5 (iPod) of your T 748. Your iPod player will show in its display the NAD logo and below it "OK to disconnect." On the other hand, the T 748 VFD will show in the upper line "iPod Menu" and the lower line "Playlists". The lower line will vary depending on the current menu selected. At the same time, the T 748 OSD will display the whole iPod Menu selections like Playlists, Artist, Albums, Genres, Songs, Composers, Audiobooks and Podcasts.
- 2 Navigate through the iPod menu selections using a combination of the [ /  / ] buttons.

NOTES

- To exit from the iPod Menu at Source 5 (iPod), press [] bringing you to "Menu Select" OSD. Follow the instructions as prompted.
- Source 5 is defaulted to iPod. For Source 5 (iPod) to be changed and allocated for other inputs, go to "iPod Setup" menu under the "Source Setup" menu. At "iPod Setup" menu, set "Enabled" to "No" – you can now assign Source 5 with another input or setting as desired.



iPod MENU OPTIONS

There are two menu options for iPod – iPod Menu and Simple Mode. At "iPod Menu", iPod navigation will be done and guided through the OSD or VFD of the T 748. At "Simple Mode" everything will be guided through your iPod's own display screen as you would do in normal iPod use.

The following is the procedure to switch between "iPod Menu" and "Simple Mode" options

- 1 Press and hold [MENU] button in the front panel or AVR 4 for about 3 seconds.
- 2 "iPod Menu" is selected when the upper line of the VFD shows "iPod Menu" and the lower line of the VFD shows "Playlists". "iPod Menu" is the default menu option.
- 3 Press and hold [MENU] button again and the upper line of the VFD shows "iPod" and the lower line of the VFD shows "Simple Mode". You are now at Simple Mode.

iPod MENU

At "iPod Menu" mode, there are several available menu options that are similar to what you can find in an iPod player. The OSD shows the following iPod Menu options – Playlists, Artists, Albums, Songs, Podcasts, Genres, Composers and Audiobook. Use [ / ] to move up or down the iPod menu selections. Navigate and select through these "iPod Menu" options as you would when operating your iPod player independently.

NOTE

At "iPod Menu", your docked iPod player's click wheel and controls will not be operational. Your iPod player will show in its display the NAD logo. Use the corresponding front panel or AVR 4 buttons to navigate through the "iPod Menu" options.

SIMPLE MODE

At "Simple Mode", refer to your docked iPod player's own display screen to navigate and make full use of its features. Use your docked iPod's own click wheel and controls or the corresponding front panel or AVR 4 buttons to select through the available options as displayed in your iPod player's display screen.

OPERATION

LISTENING TO YOUR iPod PLAYER

CONTROL FEATURES

Use the following control buttons in navigating through the iPod menu options. Since the AVR 4 will be the primary controller in most cases, we will focus on remote-controlled operations. Note that for other NAD IPD models (like NAD IPD 2) that have remote control, below controls have the same function as those available in the NAD IPD model's remote control.

DISP

During playback, toggle [DISP] key of AVR 4 to show in the VFD upper line the following

- Current iPod playback mode (shuffle, repeat modes)
- Song title
- Artist Name
- Album title

If there is no information available, the display will show "Unknown Song", "Unknown Artist" or "Unknown Album" as applicable. Aside from this information, the lower line will display the current title's song number allocation and time elapsed.



While at menu options or selection lists, toggle [▲/▼] to go up or down the options, lists or song titles. Press and hold [▲/▼] to quickly scroll through the song titles.



During playback or PAUSE mode, press and hold [⏮/⏭] for fast forward or backward scanning of current song. Press [⏭] to skip forward to the next song or [⏮] to skip back to the previous song.

PAUSE [⏸] / PLAY [▶]

Press PAUSE [⏸] during playback to stop playback temporarily. Resume play by pressing PAUSE [⏸] again or PLAY [▶].

◀/▶ (APPLICABLE ONLY IN iPod MENU MODE)

Press [◀] to return to a previous option or menu selection. Press [▶] to move forward an option or make a selection.

ENTER (APPLICABLE ONLY IN SIMPLE MODE)

Press [ENTER] to select an option or start playback.

NAD IPD 2

The NAD IPD 2 has its own remote control - the DR 1. DR 1 can be used to control NAD IPD 2 only at "Simple Mode". When using the DR 1 to command your iPod player docked in the NAD IPD 2, you have to refer to your iPod player's own display screen to make full use of its feature; there is no OSD at this condition

In addition to the above commands common to the DR 1, below are the descriptions of the other DR 1 control buttons.

LIGHT

Press [LIGHT] to turn ON the backlight of your iPod player if it is at idle mode.

MENU

Press [MENU] to return to previous option or menu selection

ENTER

Press [ENTER] to select an option or start playback.

↺ (REPEAT)

Toggle to initiate repeat mode as follows - repeat one song, repeat all songs or cancel repeat mode.

⌘ (RANDOM)

Toggle to initiate playback in random order. There are three random modes - Shuffle Song, Shuffle Album or Shuffle Off.

TO VIEW VIDEOS OR PHOTOS LOADED IN YOUR iPod

Videos or photos uploaded in your iPod can be viewed directly via the T 748. The following are the steps

- 1 Make sure that the "TV Out" setting of your iPod's Video Settings menu is at "On" mode and appropriate "TV Signal" is chosen.
- 2 Video or photo file selections and playback procedures are managed directly from your iPod player and not through the T 748. You must exit completely from the T 748's Setup Menu or Menu Select OSD for you to be able to navigate through your iPod player's video or photo menu options. A more direct way is by going to the "iPod Setup" menu and set "Enabled" to "No".
- 3 With the NAD IPD's S-VIDEO OUT and AUDIO OUT ports connected to the T 748's AUDIO 2/S-VIDEO input or to any other assignable input, you can now directly enjoy via T 748 your video or photo file selections as uploaded in your iPod. Make sure that you select the correct "Source Number" of the T 748. Note that if "Enabled" from "iPod Setup" is set to "No", ensure that Source 5 is enabled and analog audio and video settings are assigned to "A2" and "S1" respectively.

NOTE

For other navigation functions, please refer to your iPod player's owner's manual. Depending on the iPod player model, some other functions maybe controlled using the applicable T 748 navigation controls.

iPod is a trademark of Apple, Inc., registered in the U.S. and other countries.

CONDITION	POSSIBLE CAUSES	POSSIBLE SOLUTIONS
No sound from all channels.	• AC power unplugged.	• Check AC cable connection and outlet.
	• Power not switched on.	
	• Outlet has no power.	
	• Mute function is activated.	• Toggle [MUTE] button to deactivate Mute function.
No sound from some channels.	• Faulty/missing cables.	• Check cables.
	• "Speaker Configuration" channel (s) set to "OFF".	• Check "Speaker Configuration" menu.
No sound from surround channels.	• No surround listening mode is engaged.	• Select appropriate listening mode.
	• Surround channels set to "OFF" on "Speaker Configuration" menu.	• Correct "Speaker Configuration" or "Speaker Levels" settings.
	• Surround channels level set too low on "Speaker Levels" menu.	
No sound from Subwoofer.	• Subwoofer is off, not powered or improperly connected.	• Power up subwoofer, check subwoofer's AC outlet or check connections.
	• Subwoofer set to "OFF" on "Speaker Configuration" menu.	• Correct "Speaker Configuration" or "Speaker Levels" settings.
	• Subwoofer level set too low on "Speaker Levels" menu.	
No sound from Center channel.	• Source is a 2/0 (etc.) Dolby Digital or DTS recording without center channel.	• Play a known 5.1-channel recording or select Dolby Pro Logic IIx Music mode.
	• Center set to "OFF" on "Speaker Configuration" menu.	• Correct "Speaker Configuration" or "Speaker Levels" settings.
	• Center level set too low on "Speaker Levels" menu.	
No Dolby Digital/DTS.	• Source's digital output is not connected to a T 748 digital input.	• Check connections.
	• Source component not configured for multichannel digital output.	• Check source component setup.
T 748 does not respond to remote control commands.	• Batteries are flat or incorrectly inserted.	• Check batteries.
	• Infrared receiver (IR) window of T 748 or IR transmitter of the remote control is obstructed.	• Check IR windows and ensure clear line-of-sight from remote to T 748.
	• T 748 front panel is in very bright sunlight or ambient light.	• Reduce sunlight/room lighting.
No RDS information.	• Station signal too weak.	• Check station tuning. Adjust or replace antenna.
	• Station not transmitting RDS data.	• Tune to an RDS station that supports program-service name (PS mode) and radio-text mode (RT).
Display shows "No Service List".	• DAB antenna not connected properly.	• Check the connection and position of DAB antenna.
	• No DAB coverage in the area.	• Call your local DAB broadcast providers for coverage information.

REFERENCE

SPECIFICATIONS

AMPLIFIER SECTION

Power output Stereo Mode	2 x 80 W (8 ohms within rated distortion)
IHF dynamic power; 8 ohms	2 x 110 W
IHF dynamic power; 4 ohms	2 x 160 W
Power output Surround Mode	7 x 40 W
Total harmonic distortion at rated power	<0.08 %
IM distortion at rated power	<0.08 %
Damping factor, 8 ohms	>60
Input sensitivity and impedance	250 mV/47 kohms
Frequency response	±0.5 dB (ref. 1 kHz, 20 Hz – 20 kHz)
Signal/noise ratio	>100 dB (ref. rated power at 8 ohms, A-WTD)
Signal/noise ratio	>90 dB (ref. 1 W at 8 ohms, A-WTD)

TUNER SECTION

AM SECTION

Tuning range	520 kHz -1710 kHz (120 V version, 10 kHz steps) 522 kHz -1620 kHz (230 V version, 9 kHz steps)
Usable sensitivity	60 dBu
Signal/Noise ratio	40 dB
Total Harmonic Distortion	<1.5 %
Loop sensitivity 20dB S/N	60 dBu

FM SECTION

Tuning range	87.50 MHz - 108.00 MHz
Usable sensitivity, MONO	<10 dBu
S/N Ratio MONO	65 dB
S/N Ratio STEREO	60 dB
Total Harmonic Distortion, MONO	0.25 %
Total Harmonic Distortion, STEREO	0.5 %
Channel Separation	30 dB
RDS decode sensitivity	0.5 %

POWER CONSUMPTION

Idle power	50 W
Standby power	<0.5 W

PHYSICAL SPECIFICATIONS

Unit Dimensions (W x H x D)	435 x 167 x 397 mm (Gross) 17 ¹ / ₈ x 6 ⁵ / ₈ x 12 ¹³ / ₁₆ inches
Net Weight	11.5 kg (25.3 lbs)
Shipping Weight	14.0 kg (30.8 lbs)

* - Gross dimensions include feet, volume knob and extended speaker terminals.

Specifications are subject to change without notice. For updated documentation and features, please log onto www.NADelectronics.com for the latest information about T 748.

Manufactured under license under U.S. Patent Nos: 5,956,674; 5,974,380; 6,226,616; 6,487,535; 7,212,872; 7,333,929; 7,392,195; 7,272,567 & other U.S. and worldwide patents issued & pending. DTS-HD, the Symbol, & DTS-HD and the Symbol together are registered trademarks & DTS-HD Master Audio is a trademark of DTS, Inc. Product includes software. © DTS, Inc. All Rights Reserved.

Dolby and the double-D symbol are registered trademarks of Dolby Laboratories.

HDMI, the HDMI logo and High-Definition Multimedia Interface are trademarks or registered trademarks of HDMI Licensing LLC.



www.NADelectronics.com

**©2014 NAD ELECTRONICS INTERNATIONAL
A DIVISION OF LENBROOK INDUSTRIES LIMITED**

All rights reserved. NAD and the NAD logo are trademarks of NAD Electronics International, a division of Lenbrook Industries Limited.
No part of this publication may be reproduced, stored or transmitted in any form without the written permission of NAD Electronics International.
While every effort has been made to ensure the contents are accurate at the time of publication, features and specifications may be subject to change without prior notice.

T748R2_ENG_OM_V09 - JAN 2014