



VISO 1 *AP*

Wireless AirPlay® Music System

ENGLISH



Owner's Manual

IMPORTANT SAFETY INSTRUCTIONS

**SAVE THESE INSTRUCTIONS FOR LATER USE
FOLLOW ALL WARNINGS AND INSTRUCTIONS MARKED ON THE AUDIO
EQUIPMENT.**

- 1. Read instructions** - All the safety and operating instructions should be read before the product is operated.
- 2. Retain instructions** - The safety and operating instructions should be retained for future reference.
- 3. Heed Warnings** - All warnings on the product and in the operating instructions should be adhered to.
- 4. Follow Instructions** - All operating and use instructions should be followed.
- 5. Cleaning** - Unplug this product from the wall outlet before cleaning. Do not use liquid cleaners or aerosol cleaners. Clean only with dry cloth.
- 6. Attachments** - Do not use attachments not recommended by the product manufacturer as they may cause hazards.
- 7. Water and Moisture** - Do not use this product near water-for example, near a bath tub, wash bowl, kitchen sink, or laundry tub; in a wet basement; or near a swimming pool; and the like.
- 8. Accessories** - Do not place this product on an unstable cart, stand, tripod, bracket, or table. The product may fall, causing serious injury to a child or adult, and serious damage to the product. Use only with a cart, stand, tripod, bracket, or table recommended by the manufacturer, or sold with the product. Any mounting of the product should follow the manufacturer's instructions, and should use a mounting accessory recommended by the manufacturer.
-  **9.** A product and cart combination should be moved with care. Quick stops, excessive force, and uneven surfaces may cause the product and cart combination to overturn.
- 10. Ventilation** - Slots and openings in the cabinet are provided for ventilation and to ensure reliable operation of the product and to protect it from overheating, and these openings must not be blocked or covered. The openings should never be blocked by placing the product on a bed, sofa, rug, or other similar surface. This product should not be placed in a built-in installation such as a bookcase or rack unless proper ventilation is provided or the manufacturer's instructions have been adhered to.
- 11. Power Sources** - This product should be operated only from the type of power source indicated on the marking label. If you are not sure of the type of power supply to your home, consult your product dealer or local power company. The primary method of isolating the amplifier from the mains supply is to disconnect the mains plug. Ensure that the mains plug remains accessible at all times. Unplug the AC power cord from the AC outlet if the unit will not be used for several months or more. The socket-outlet shall be installed near the equipment and shall be easily accessible.
- 12. Grounding or Polarization** - This product may be equipped with a polarized alternating-current line plug (a plug having one blade wider than the other). This plug will fit into the power outlet only one way. This is a safety feature. If you are unable to insert the plug fully into the outlet, try reversing the plug. If the plug should still fail to fit, contact your electrician to replace your obsolete outlet. Do not defeat the safety purpose of the polarized plug.
- 13. Power Cord Protection** - Power-supply cords should be routed so that they are not likely to be walked on or pinched by items placed upon or against them, paying particular attention to cords at plugs, convenience receptacles, and the point where they exit from the product.
- 14. Outdoor Antenna Grounding** - If an outside antenna or cable system is connected to the product, be sure the antenna or cable system is grounded so as to provide some protection against voltage surges and built-up static charges. Article 810 of the National Electrical Code, ANSI/NFPA 70, provides information with regard to proper grounding of the mast and supporting structure, grounding of the lead-in wire to an antenna discharge unit, size of grounding conductors, location of antenna discharge unit, connection to grounding electrodes, and requirements for the grounding electrode.
- 15. Lightning** - For added protection for this product during a lightning storm, or when it is left unattended and unused for long periods of time, unplug it from the wall outlet and disconnect the antenna or cable system. This will prevent damage to the product due to lightning and power line surges.
- 16. Power Lines** - An outside antenna system should not be located in the vicinity of overhead power lines or other electric light or power circuits, or where it can fall into such power lines or circuits. When installing an outside antenna system, extreme care should be taken to keep from touching such power lines or circuits as contact with them might be fatal.
- 17. Overloading** - Do not overload wall outlets, extension cords, or integral convenience receptacles as this can result in a risk of fire or electric shock.

18. Object and Liquid Entry - Never push objects of any kind into this product through openings as they may touch dangerous voltage points or short out parts that could result in a fire or electric shock. Never spill liquid of any kind on the product.

WARNING: THE APPARATUS SHOULD NOT BE EXPOSED TO DRIPPING OR SPLASHING, AND OBJECTS FILLED WITH LIQUIDS, SUCH AS VASES, SHOULD NOT BE PLACED ON THE APPARATUS. AS WITH ANY ELECTRONIC PRODUCTS, USE CARE NOT TO SPILL LIQUIDS INTO ANY PART OF THE SYSTEM. LIQUIDS CAN CAUSE A FAILURE AND/OR A FIRE HAZARD.

19. Damage Requiring Service - Unplug this product from the wall outlet and refer servicing to qualified service personnel under the following conditions:

- When the power supply cord or plug is damaged.
- If liquid has been spilled, or objects have fallen into the product.
- If the product has been exposed to rain or water.
- If the product does not operate normally by following the operating instructions. Adjust only those controls that are covered by the operating instructions as an improper adjustment of other controls may result in damage and will often require extensive work by a qualified technician to restore the product to its normal operation.
- If the product has been dropped or damaged in any way.
- When the product exhibits a distinct change in performance-this indicates a need for service.

20. Replacement Parts - When replacement parts are required, be sure the service technician has used replacement parts specified by the manufacturer or have the same characteristics as the original part. Unauthorized substitutions may result in fire, electric shock, or other hazards.

21. Safety Check - Upon completion of any service or repairs to this product, ask the service technician to perform safety checks to determine that the product is in proper operating condition.

22. Heat - The product should be situated away from heat sources such as radiators, heat registers, stoves or other products (including amplifiers) that produce heat.

Battery shall not be exposed to excessive heat such as sunshine, fire or the like.

WARNING

TO REDUCE THE RISK OF FIRE OR ELECTRIC SHOCK, DO NOT EXPOSE THIS PRODUCT TO RAIN OR MOISTURE.

CAUTION

TO PREVENT ELECTRIC SHOCK, MATCH WIDE BLADE OF PLUG TO WIDE SLOT, FULLY INSERT.

RESPONSIBLE PARTY

LENBROOK AMERICA
6 Merchant Street
Sharon, MA 02067
USA
Telephone: 800 263 4641
781 784 8586
Facsimile: 781 784 8386

WARNING

Changes or modifications to this unit not expressly approved by the party responsible for compliance could void the user's authority to operate the equipment.

NOTE

Shielded cables must be used with this unit to ensure compliance with the Class B FCC limits.

Under the influence of electrostatic phenomenon, the product may malfunction and require user to reset.

Under environment with radio frequency interference, the product may malfunction and require user to reset.

Under the environment with electrical fast transient, the product may malfunction and require user to reset.

Caution Marking and rating plate is located at bottom enclosure of the apparatus.

CAUTION

Danger of explosion if battery is incorrectly replaced. Replace only with the same or equivalent type.

An appliance with a protective earth terminal should be connected to a mains outlet with a protective earth connection.

NOTE

This equipment has been tested and found to comply with the limits for a Class B digital device, pursuant to Part 15 of the FCC Rules. These limits are designed to provide reasonable protection against harmful interference in a residential installation. This equipment generates, uses and can radiate radio frequency energy and, if not installed and used in accordance with the instructions, may cause harmful interference to radio communications. However, there is no guarantee that interference will not occur in a particular installation. If this equipment does cause harmful interference to radio or television reception, which can be determined by turning the equipment off and on, the user is encouraged to try to correct the interference by one or more of the following measures:

- Reorient or relocate the receiving antenna.
- Increase the separation between the equipment and receiver.
- Connect the equipment into an outlet on a circuit different from that to which the receiver is connected.
- Consult the dealer or an experienced radio/TV technician for help.

CAN ICES-3 (B)/NMB-3(B)

This device complies with Industry Canada license-exempt RSS-210. Operation is subject to the following two conditions: (1) this device may not cause Interference, and (2) this device must accept any interference, including interference that may cause undesired operation of the device.

- no naked flame sources such as lighted candles should be placed on the apparatus;
- the use of apparatus in tropical climate

This device complies with Part 15 of the FCC rules. Operation is subject to the following two conditions:

- (1) This device may not cause harmful interference, and
- (2) This device must accept any interference received, including interference that may cause undesired operation.



THE LIGHTNING FLASH WITH ARROWHEAD SYMBOL, WITHIN AN EQUILATERAL TRIANGLE, IS INTENDED TO ALERT THE USER TO THE PRESENCE OF UNINSULATED "DANGEROUS VOLTAGE" WITHIN THE PRODUCT'S ENCLOSURE THAT MAYBE OF SUFFICIENT MAGNITUDE TO CONSTITUTE A RISK OF ELECTRIC SHOCK TO PERSONS.



THE EXCLAMATION POINT WITHIN AN EQUILATERAL TRIANGLE IS INTENDED TO ALERT THE USER TO THE PRESENCE OF IMPORTANT OPERATING AND MAINTENANCE (SERVICING) INSTRUCTIONS IN THE LITERATURE ACCOMPANYING THE APPLIANCE.



CAUTION REGARDING PLACEMENT

To maintain proper ventilation, be sure to leave a space around the unit (from the largest outer dimensions including projections) that is equal to or greater than shown below.

Left and Right Panels: 10 cm
Rear Panel: 10 cm

WARNING

If this product is used at 240VAC, a suitable attachment plug should be used.

FCC RF RADIATION EXPOSURE STATEMENT

Caution: To maintain compliance with the FCC's RF exposure guidelines, place the VISO 1 AP at least 20cm from nearby persons.

EUROPEAN UNION NOTICE FOR WIRELESS PRODUCT



Hereby, Lenbrook Industries Limited, declares that this Wireless Music System is in compliance with the R&TTE Directive (1999/5/EC), Low Voltage Directive (2006/95/EC) and other essential requirements. The declaration of conformity may be consulted at www.lenbrook.com/DoC.

NOTES ON ENVIRONMENTAL PROTECTION



At the end of its useful life, this product must not be disposed of with regular household waste but must be returned to a collection point for the recycling of electrical and electronic equipment. The symbol on the product, owner's manual and packaging, point this out.

The materials can be reused in accordance with their markings.

Through re-use, recycling of raw materials or other forms of recycling of old products, you are making an important contribution to the protection of our environment. Your local administrative office can advise you of the responsible waste disposal point.

INFORMATION ABOUT COLLECTION AND DISPOSAL OF WASTE BATTERIES (DIRECTIVE 2006/66/EC OF THE EUROPEAN PARLIAMENT AND THE COUNCIL OF EUROPEAN UNION) (FOR EUROPEAN CUSTOMERS ONLY)

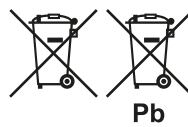

Batteries bearing any of these symbols indicate that they should be treated as "separate collection" and not as municipal waste. It is encouraged that necessary measures are implemented to maximize the separate collection of waste batteries and to minimize the disposal of batteries as mixed municipal waste.

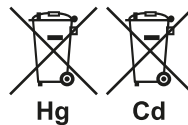

End-users are exhorted not to dispose of waste batteries as unsorted municipal waste. In order to achieve a high level of recycling waste of batteries, discard waste batteries separately and properly through an accessible collection point in your vicinity. For more information about collection and recycling of waste batteries, please contact your local municipality, your waste disposal service or the point of sale where you purchased the items.

By ensuring compliance and conformance to proper disposal of waste batteries, potential hazardous effects on human health is prevented and the negative impact of batteries and waste batteries on the environment is minimized, thus contributing to the protection, preservation and quality improvement of the environment.



WARNING: DO NOT INGEST BATTERY, CHEMICAL BURN HAZARD

The remote control supplied with this product contains a coin/button cell battery. If the coin/button cell battery is swallowed, it can cause severe internal burns in just 2 hours and can lead to death.

Keep new and used batteries away from the children. If the battery compartment does not close securely, stop using the product and keep it away from children.

If you think batteries might have been swallowed or placed inside a part of the body, seek immediate medical attention.

INTRODUCTION

Thank you for choosing NAD.

The NAD VISO 1 AP is the latest evolution of the VISO 1 Wireless Digital Music System. NAD VISO 1 AP takes the award-winning audio performance of the original NAD VISO 1 and adds the versatility of Wi-Fi and Apple AirPlay. A USB port at the rear is also added to allow direct connection and charging of Apple's iPhone, iPad or iPod touch.

Using NAD's Direct Digital technology to eliminate all analog stages along with their inherent noise and distortion, the NAD VISO 1 AP is a complete digital device. NAD uses a sophisticated closed loop DAC technology to directly power the speakers. Acoustic design is provided by NAD's sister company, PSB Speakers, and the amplification and acoustic design is fully integrated to create very impressive synergies. The result is a shelf system with enough acoustic power to fill a large room, guaranteed lowest distortion and widest frequency response.

As with all our products, NAD's "Music First" design philosophy guided the VISO 1 AP design that it can confidently promise you both state-of-the-art technology and audiophile-quality music listening for years to come.

We encourage you to take a few minutes now to read right through this manual. Investing a little time here at the outset might save you a good deal of time later, and is by far the best way to ensure that you make the most of your investment in the VISO 1 AP.

For warranty information contact your local distributor.

NAD SHALL NOT BE HELD LIABLE FOR ANY TECHNICAL OR USER INTERFACE DISCREPANCIES IN THIS MANUAL. THE VISO 1 AP OWNER'S MANUAL MAY BE SUBJECT TO CHANGE WITHOUT PRIOR NOTICE. CHECK OUT THE NAD WEBSITE FOR THE LATEST VERSION OF THE VISO 1 AP OWNER'S MANUAL.

WHAT'S IN THE BOX

Packed with your VISO 1 AP you will find VISO 1 AP accessories box containing the following

- Two detachable mains power cord
- The VISO 1 AP remote control with 3V CR2025 battery
- Cleaning cloth
- VISO 1 AP Quick Setup Guide

SAVE THE PACKAGING

Please save the box and all of the packaging in which your VISO 1 AP arrived. Should you move or otherwise need to transport your VISO 1 AP, this is by far the safest container in which to do so. We've seen too many otherwise perfect components damaged in transit for lack of a proper shipping carton, so please: Save that box!

CHOOSING A LOCATION

Provide enough space (at least 10 cm) around the VISO 1 AP port to allow air flow freely. Ensure that there is a clear line of sight, within 25 feet/8 meters, between the VISO 1 AP's front view and your primary listening/viewing position - this will allow reliable infrared remote control communications.

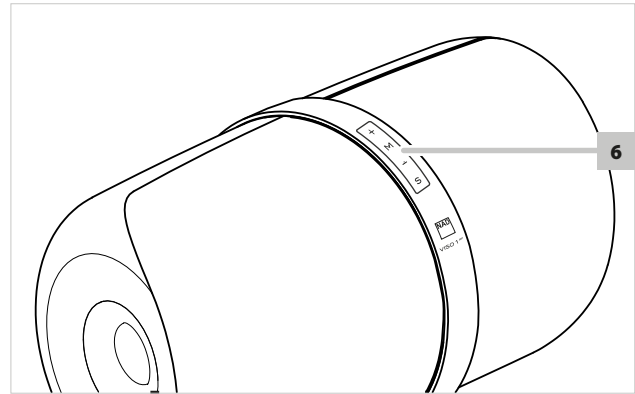
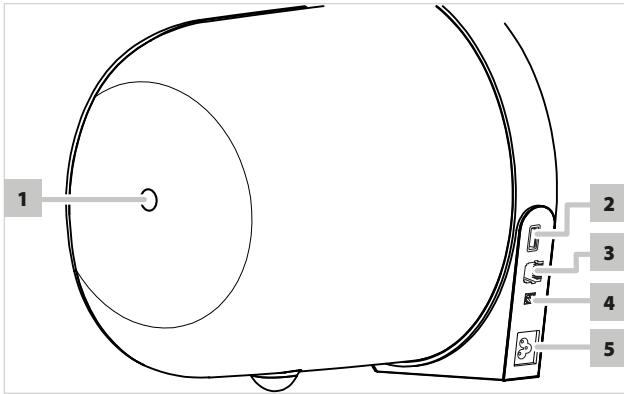

1 STANDBY BUTTON

- Toggle this button to set the VISO 1 AP to standby mode or switch ON the VISO 1 AP from standby mode.
- The VISO 1 AP can also be switched ON from standby mode by pressing any of the panel keys S, M, + or - .
- When VISO 1 AP is switched ON from standby mode, the last Source used will be selected.

NOTE

The Standby (ON/OFF) button will not shut down the VISO 1 AP. Disconnect the mains power plug from the mains power source to completely shut down the VISO 1 AP.

2 USB

- Allow direct connection and charging of Apple's iPhone, iPad and iPod touch using applicable connector (not supplied).
- VISO 1 AP may need a software update to be in step with the latest technology trends. Connect to this input a USB memory stick containing the software update.
- Only authorized NAD distributors or service centers are allowed to implement a software update.
- Check with your authorized NAD distributors for future software updates.

3 LAN

LAN connection must be setup for wired connection to be established. Set up a Wired Ethernet broadband router with broadband internet connection. Your router or home network should have a built-in DHCP server to consummate the connection.

- Connect the VISO 1 AP to a network by directly connecting one end of an Ethernet cable to the LAN port of your wired Ethernet broadband router and the other end to VISO 1 AP's LAN port. Use a standard straight-through Ethernet cable (not supplied).

NOTE

AirPlay lets you stream music from your AirPlay-enabled device to the VISO 1 AP. The AirPlay-enabled device and the VISO 1 AP must be in the same network to send and receive streaming audio with AirPlay.

4 OPTICAL (S/PDIF) IN

- Connect OPTICAL IN of VISO 1 AP to the corresponding optical digital output of sources such as CD, DVD or BD players, digital cable box, digital tuners and other applicable components.
- The optical digital input is 24/96 capable.
- The optical digital input accepts PCM audio signal only. Ensure that the digital audio output of your source is set to PCM before it is connected to the optical digital input of VISO 1 AP.

5 AC MAINS INPUT

- The VISO 1 AP comes supplied with a separate detachable mains power cord. There are 2 supplied power cords – select applicable type for your usage. Before connecting the plug to the mains powers source, connect firmly first the other end to VISO 1 AP's AC Mains input socket.
- Always disconnect the mains power plug from the mains power source first, before disconnecting the cable from the VISO 1 AP's AC Mains input socket.
- Power Rating: 100 - 240V ~50/60Hz 35W.

NOTES

- *Disconnect the mains power plug from the mains power source to completely shut down the VISO 1 AP.*
- *The VISO 1 AP will power up to its last Source setting prior to being shut down.*

6 S, M,+/-

- Press "+" to increase the volume level; "-" to lower it.
- Toggle "M" to temporarily mute audio level or restore audio from mute mode. "S" will continuously flash at mute mode.
- Pressing "+" or "-" will restore audio from mute mode.
- "S" indicator flashes whenever a remote control command is received.
- Toggle "S" button to sequentially select through the following source modes
 - a AirPlay/iOS/iPod nano device
 - b Bluetooth device
 - c Optical (S/PDIF) source

Below is a description of the various color modes of the S-indicator light.

S-INDICATOR LIGHT COLOR	FUNCTION/DESCRIPTION
Alternately flashing in red and green	Ready to be configured Factory default setting
Flashing green	Access point/setup mode
Solid green	AirPlay/iOS/iPod nano device source mode
Solid blue	Bluetooth device source mode
Solid amber	Optical (S/PDIF) source mode
Off (no color)	Standby mode

VISO 1 REMOTE CONTROL

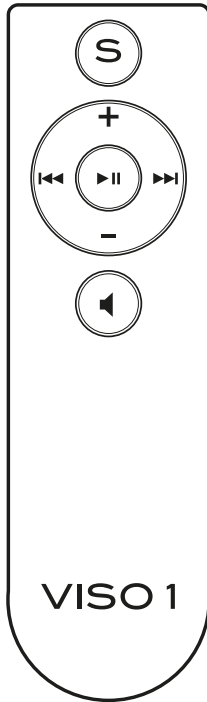

S Sequentially select through Sources.

+/- Increase or decrease loudness level.

🔊 Temporarily mutes audio output or restores audio from mute mode.

The following remote control commands are applicable only in AirPlay mode or when using an iOS device

▶▶ Skip forward to the next song.
Skip forward through parts of the current broadcast or song (if applicable).

◀◀ Skip back to the previous song.
Skip back through parts of the current broadcast or song (if applicable).

▶|| Start playback.
Pause playback temporarily.

FIRST TIME USE

Out of the box and connecting the VISO 1 AP to the mains power source for the first time, the "S" indicator will alternately switch to green and red light after initializing. This indicates that the VISO 1 AP is ready to be configured. Refer to the following sections to fully enjoy and appreciate your VISO 1 AP.

SETTING UP NETWORK CONNECTION

AirPlay lets you stream music from your AirPlay-enabled device to the VISO 1 AP. The AirPlay-enabled device and the VISO 1 AP must be in the same network to send and receive streaming audio with AirPlay.

The VISO 1 AP can be connected to a network using any of the following methods

- A Wired connection
- B Wireless connection
- C Share Wi-Fi setting

Start playback of your device after successful network connection using any of the above methods.

WIRED CONNECTION

Network connection using Ethernet broadband connection. Set up a Wired Ethernet broadband router with broadband internet connection. Your router or home network should have a built-in DHCP server to consummate the connection.

- Using a standard straight-through Ethernet cable, connect one end of the Ethernet cable (not supplied) to the LAN port of your wired Ethernet broadband router and the other end to VISO 1 AP's LAN port.
- The "S" indicator will turn to solid green upon successful network connection.

It is advisable that wired connection is utilized when possible. Wired connection is less likely to have "drop-out" or range problem and not vulnerable to interference or eavesdropping.

WIRELESS CONNECTION

Wireless (WiFi) broadband router with broadband internet connection is required for wireless connection to be established. Wireless connection for VISO 1 AP can be setup by the following procedure.

- 1 Press and hold "S" until it turns flashing green – this indicates it is in Access point/setup mode already.
- 2 Using your iOS device (iPad is used here for reference), select among the list of available network connections the unique network ID (NAD_VISO1_DF601A in this example) of your VISO 1 AP.

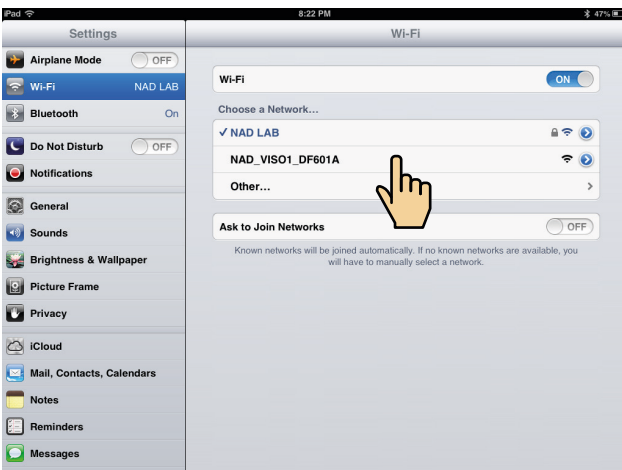

- 3 Launch Safari and enter **http://192.168.1.12**. The **VISO 1 AP User Interface** menu window will appear. Select **Profile Configuration**.

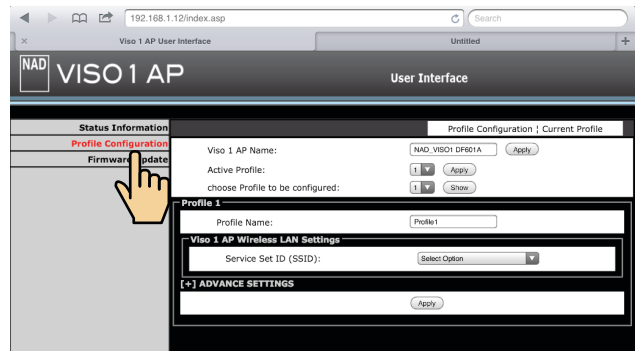

- 4 Select your local network from the drop down SSID list (NADLAB (WPA2 TKIP+CCMP) in this example).

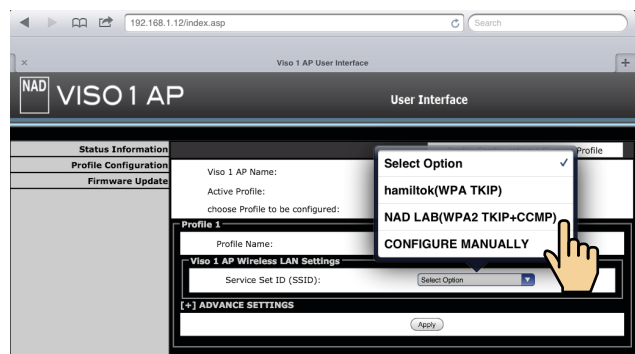

NOTES

- **The Status Information** displays current details about your VISO 1 AP like connection status, signal strength, firmware version and others. If your VISO 1 AP is configured already, locate and access the TCP/IP address of your VISO 1 AP to check **Status Information**.
 - **Firmware Update** is not for consumer use- this is restricted to authorized NAD service personnel and distributors.
- 5 Type the **WPA Passphrase** (if it is password protected) of your local network in the field provided and then select **Apply** to join in.

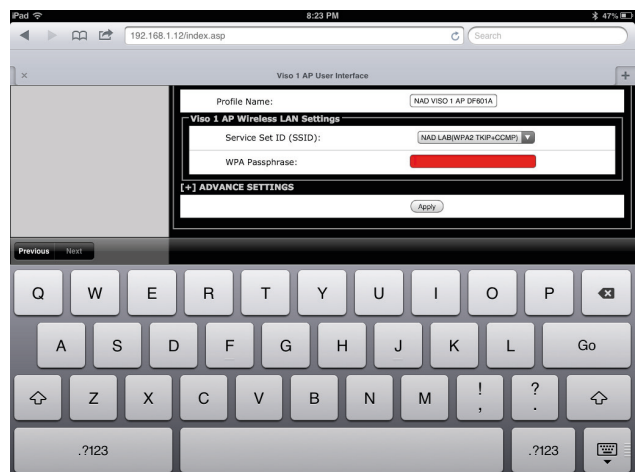

VISO 1 AP OPERATION

- 6 A Warning notice will pop-up. Select **OK** to save the new settings. "S" will continuously flash until it turns solid green. Network connection is successfully established with "S" turning to solid green. Your iOS device (iPad) is now interfaced with the VISO 1 AP.

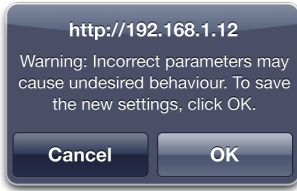

- 7 Return to the **Wi-Fi** settings of your iOS (iPad) device and ensure that it is set to the same network setting as above (**NADLAB**).

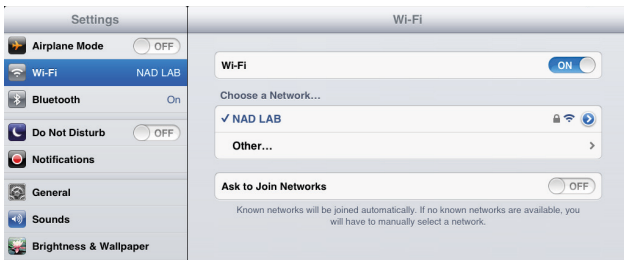

SHARE WIFI SETTINGS

WiFi connection can also be achieved by directly connecting your iOS device to the USB input of the VISO 1 AP. Follow below procedure for automatic network detection and connection.

- 1 Using applicable Apple USB cable (not supplied), connect iOS device to USB input of VISO 1 AP to share WiFi settings.

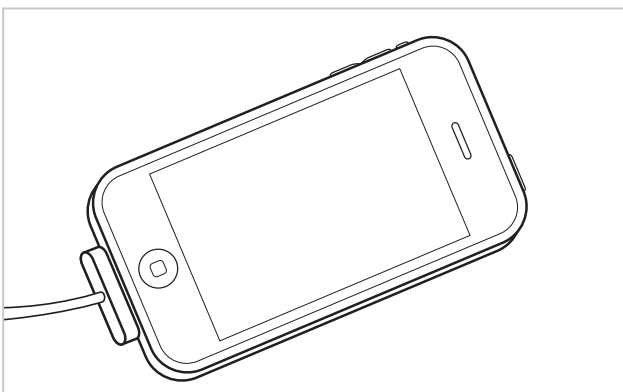
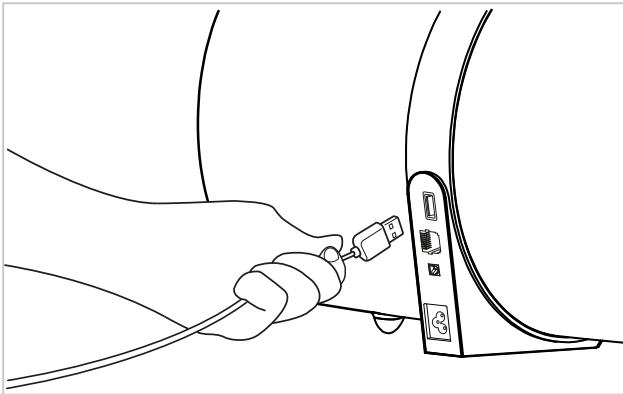

- 2 Press and hold "M" and "S".

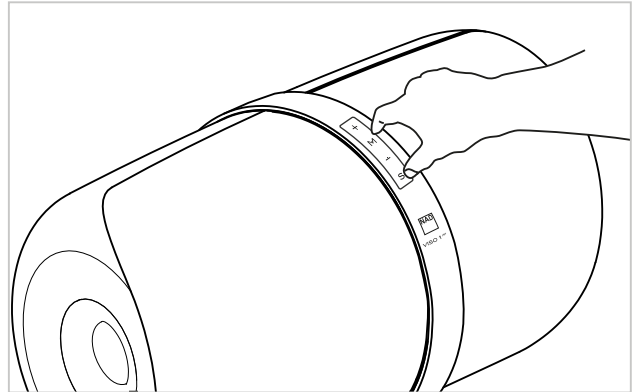

- 3 From iOS device, select "Allow". Enter correct network username and password when prompted. Select AirPlay .

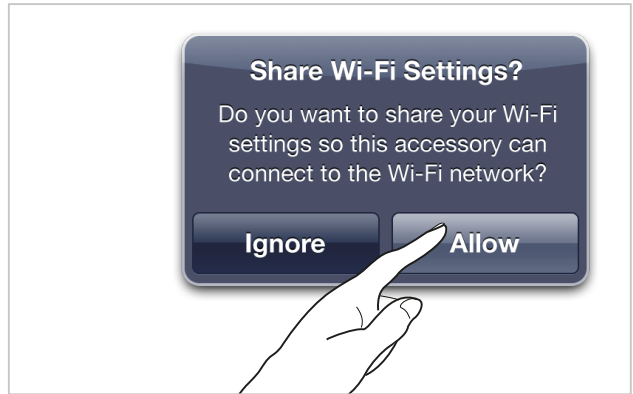

NOTE

Upon successful WiFi sharing, you can disconnect iOS device from VISO 1 AP. AirPlay as a Source takes priority over connected iPod or iOS devices.

SOURCE SELECTION

There are three Sources that VISO 1 AP can select. These are

- 1 AirPlay/iOS/iPod nano device*
- 2 Bluetooth device
- 3 Optical (S/PDIF) source

VISO 1 AP will output the audio from any of the above sources upon successful detection or connection.

AIRPLAY

AirPlay lets you stream music from your AirPlay-enabled device to the VISO 1 AP. The AirPlay-enabled device and the VISO 1 AP must be in the same network to send and receive streaming audio with AirPlay. This connection could be wired, using an Ethernet cable, or wireless.

- After your AirPlay-enabled device and VISO 1 AP are connected to the same network, the Airplay source will detect the VISO 1 AP. Select the AirPlay icon (📶) that appears in the application display and select the unique ID of your VISO 1 AP (**NAD_VISO1_DF601A** in the example below).

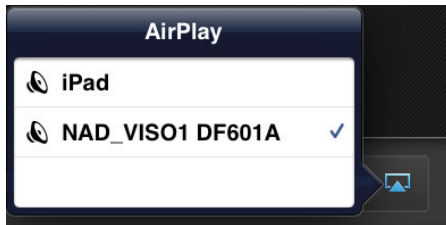

- Audio from iTunes running from your MAC or PC can also be streamed using AirPlay as long as they are connected to the same network.

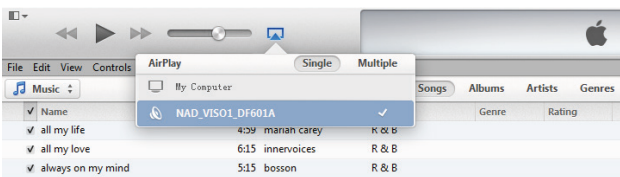

iOS/iPod NANO DEVICE*

You can directly playback your iOS/iPod nano device with VISO 1 AP if you prefer not to use AirPlay.

- 1 Using applicable Apple USB connector, connect your iOS/iPod nano device to the USB input of VISO 1 AP.
- 2 Toggle "S" until it turns to green light – AirPlay/iOS/iPod nano device mode. If AirPlay is disconnected or unavailable, the VISO 1 AP will automatically playback the source. If AirPlay is available, select "Dock connector" (if applicable) to playback the connected source.

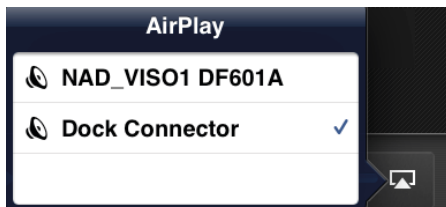

In some cases, you may need to toggle or cycle through "S" to activate AirPlay mode or iOS/iPod nano device mode.

*Refer to the section below about **iOS/iPod SUPPORTED BY VISO 1 AP** for a list of compatible devices.

BLUETOOTH DEVICE

Bluetooth creates wireless connection between compatible devices by being paired together.

- 1 Ensure that your Bluetooth device is active or turned ON.
- 2 Pair or connect your Bluetooth device with the unique device ID of your VISO 1 AP which is listed as the product name (VISO1 AP) together with the last six characters of your unit's MAC (Machine Access Control) address (example: VISO1 AP DF8036).



- 3 Toggle "S" until it turns to blue light – Bluetooth device mode. Start playback of your Bluetooth device upon connection.

VISO 1 AP OPERATION

OPTICAL (S/PDIF) SOURCE

Connect OPTICAL IN of VISO 1 AP to the corresponding optical digital output of sources such as CD, DVD or BD players, digital cable box, digital tuners and other applicable components. Toggle "S" until it turns to solid amber (Optical (S/PDIF) mode).

IMPORTANT NOTES

- The optical digital input is 24/96 capable.
- The optical digital input accepts PCM audio signal only. Ensure that the digital audio output of your source is set to PCM before it is connected to the optical digital input of VISO 1 AP.

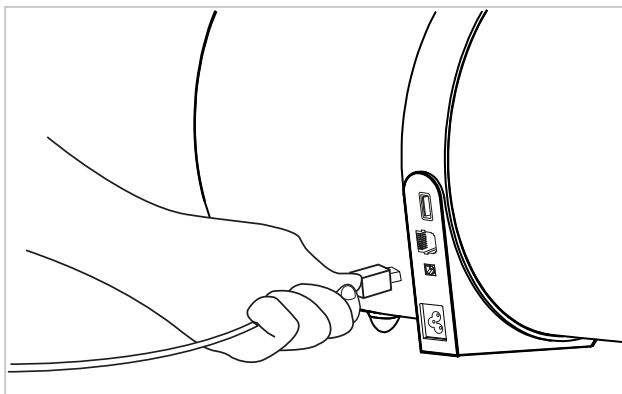
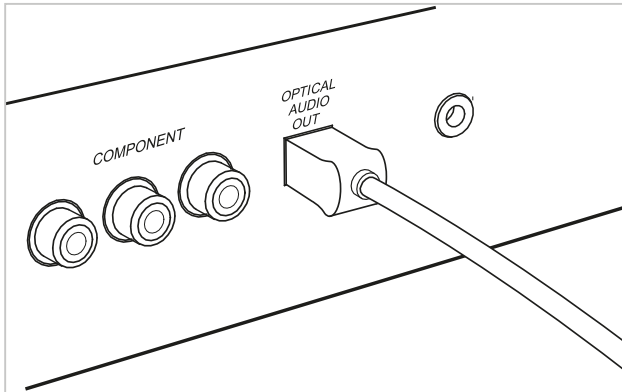

RESTORING VISO 1 AP TO ITS FACTORY DEFAULT SETTINGS

You may restore your VISO 1 AP to its factory default settings. Resetting your VISO 1 AP may address the remote possibility of your VISO 1 AP exhibiting some glitches or inadvertent functionality issues. Follow the procedure below to reset your VISO 1 AP.

- 1 Disconnect and then reconnect your VISO 1 AP to the mains power source. As soon as "S" (in green) begins to flash, press and hold "-" until the "S" indicator turns off. Release "-".
- 2 VISO 1 AP will continue to initialize.
- 3 The "S" indicator will then alternately switch to green and red light after initializing. This indicates that the VISO 1 AP is ready to be configured again.

iOS/iPod DEVICES SUPPORTED BY VISO 1 AP

The following is a table listing the iOS and iPod devices supported by VISO 1 AP. This list will be updated when newer versions or devices become available and compatible with VISO 1 AP. Updated list will be posted in the NAD website page for VISO 1 AP.

iOS/iPod SUPPORTED BY VISO 1 AP			
Device	Software	Device	Software
iPod nano 3rd Gen	v1.1.3	iPhone 3G	iOS 4.2.1
iPod nano 4th Gen	v1.0.3	iPhone 3GS	iOS 6.0.1
iPod nano 5th Gen	v1.0.2	iPhone 4	iOS 6.0.1
iPod nano 6th Gen	v1.2	iPhone 4S	iOS 6.0.1
iPod nano 7th Gen	v1.0.1	iPhone 5	iOS 6.0.1
iPod touch 1st Gen	iOS 3.1.3	iPad	iOS 5.1.1
iPod touch 2nd Gen	iOS 4.2.1	iPad 2	iOS 6.0.1
iPod touch 3rd Gen	iOS 5.1.1	iPad 3rd Gen	iOS 6.0.1
iPod touch 4th Gen	iOS 6.0.1		
iPod touch 5th Gen	iOS 6.0.1		



www.NADelectronics.com

**©2014 NAD ELECTRONICS INTERNATIONAL
A DIVISION OF LENBROOK INDUSTRIES LIMITED**

All rights reserved. NAD and the NAD logo are trademarks of NAD Electronics International, a division of Lenbrook Industries Limited.
No part of this publication may be reproduced, stored or transmitted in any form without the written permission of NAD Electronics International.
While every effort has been made to ensure the contents are accurate at the time of publication, features and specifications may be subject to change without prior notice.

VISO1AP_ENG_OM_V08 - SEP 2014