



# VISO 1 *AP*

Wireless AirPlay® Music System

---



---

Quick Setup Guide

Guide de configuration rapide

Guía de inicio rápido

Guia de configuração rápida

Guida di installazione rapida

Schnellinstallationsanleitung

ENGLISH

FRANÇAIS

ESPAÑOL

PORTUGUÊS

ITALIANO

DEUTSCH

## WHAT'S IN THE BOX

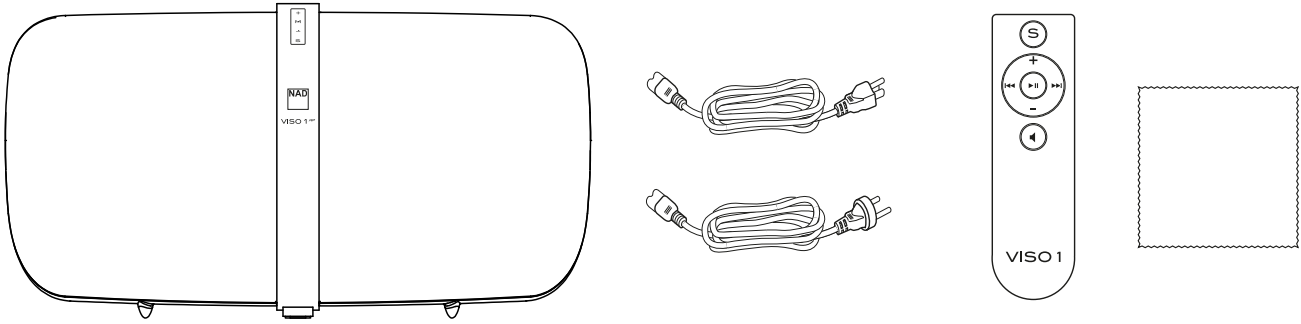

### IMPORTANT!

- Download the VISO 1 AP Owner's Manual from the Manuals/Downloads tab of the NAD website link: <http://nadelectronics.com/products/made-for-ipod/VISO-1-AP-AirPlay-Bluetooth-Music-System>
- NAD VISO 1 AP supports AirPlay and Bluetooth Audio (SBC, AAC, and aptX codecs over A2DP). It also supports direct digital audio over USB connection to supported Apple iPod and iOS (iPad, iPhone, iPod touch) devices.

## CONNECT, PLUG AND PLAY!

### POWER UP!

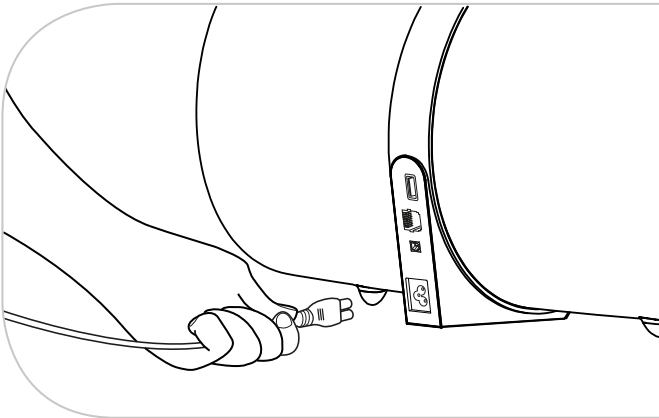

1 Connect the supplied power cord to AC mains input of VISO 1 AP.

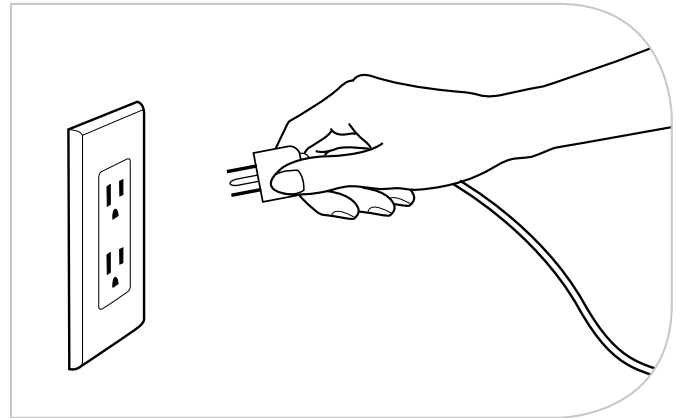

2 Connect the power cord to a live AC wall outlet.

### iPod OR iOS DEVICES

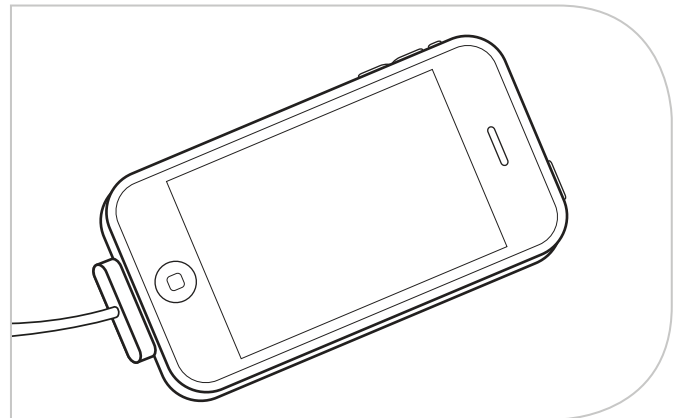
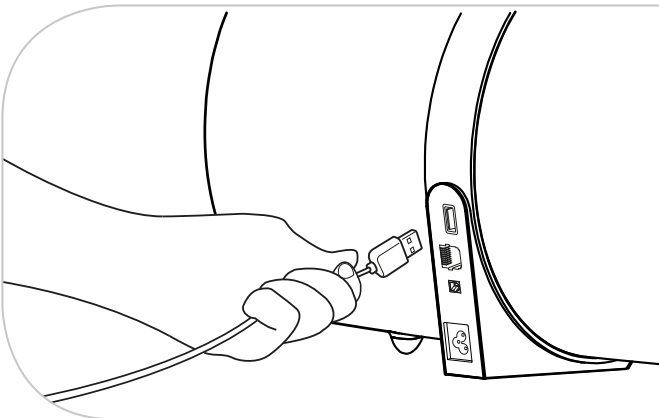

Connect iPod or iOS device to USB input of VISO 1 AP using applicable Apple USB cable (not supplied).

### AIRPLAY

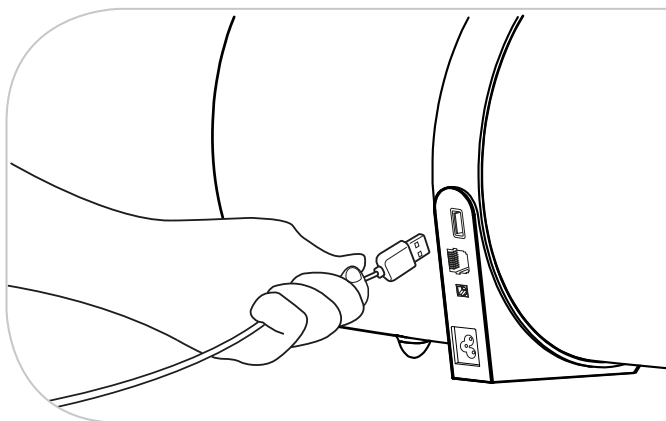

1 Using applicable Apple USB cable (not supplied), connect iOS device to USB input of VISO 1 AP to share WiFi settings.

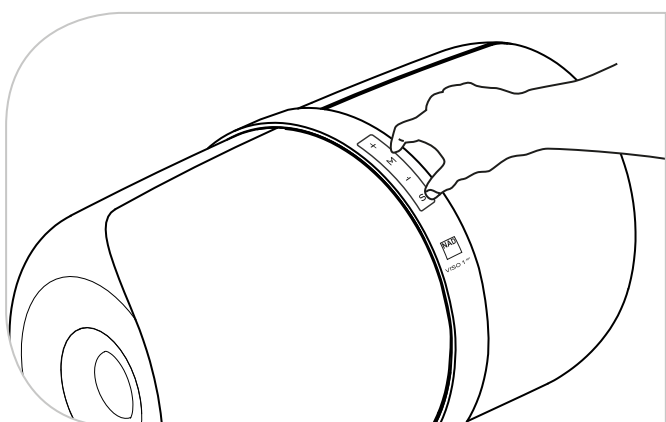
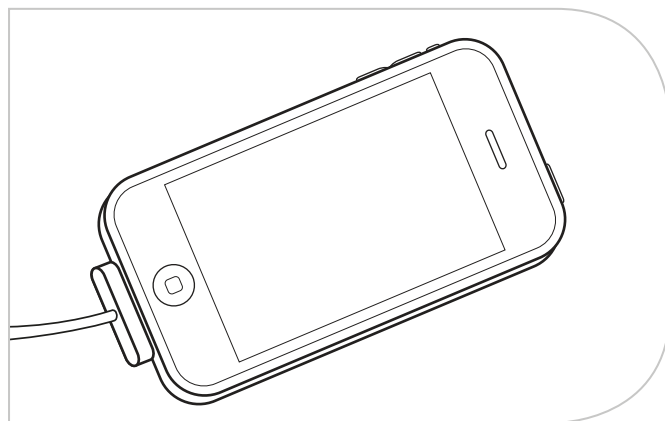

2 Press and hold "M" and "S".

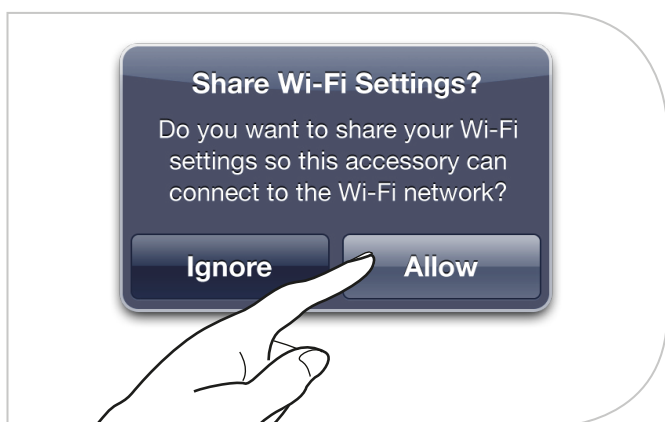

3 From iOS device, tap "Allow". Enter correct network username and password when prompted. Tap AirPlay .

**NOTE:** Upon successful WiFi sharing, you can disconnect iOS device from VISO 1 AP. AirPlay as a Source takes priority over connected iPod or iOS devices.

### EXTERNAL DEVICE WITH OPTICAL DIGITAL OUTPUT

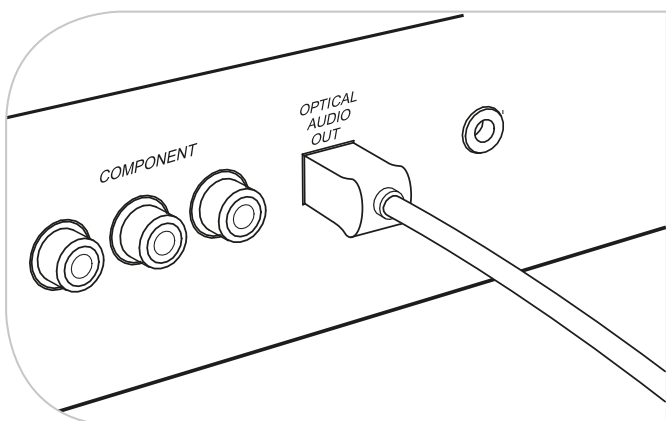

Connect VISO 1 AP to the optical digital output of an external device using an optical cable (not supplied).

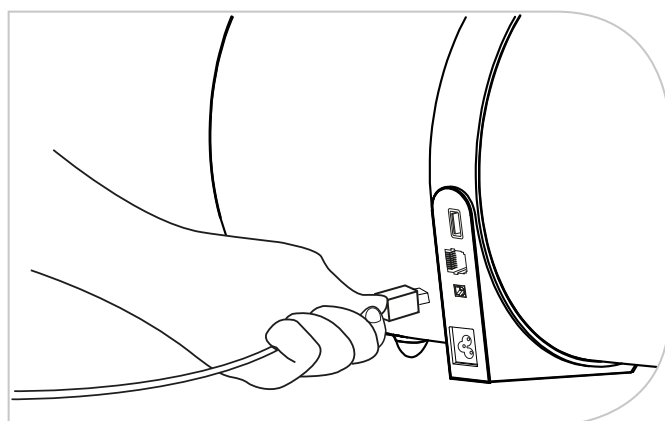

Ring Control: Volume Level

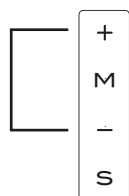

Mute

Source Selector

AirPlay/iPod or iOS device → Bluetooth → Optical



Pair NAD VISO 1 AP to your Bluetooth device list.

## CONTENU DE LA BOÎTE

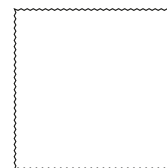
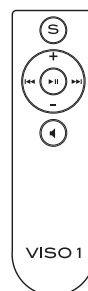
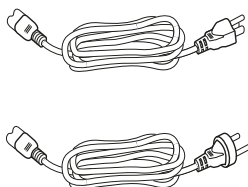
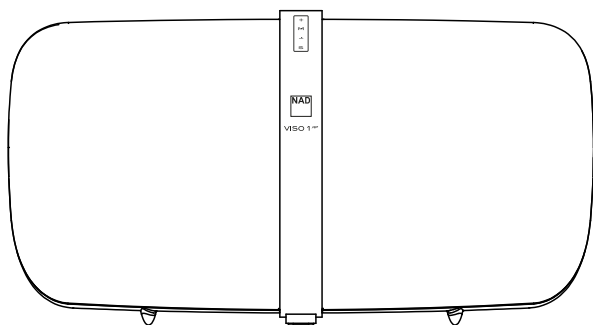

### IMPORTANT!

- Téléchargez le guide d'utilisation du VISO 1 AP de l'onglet Manuals/Downloads du site NAD au lien ci-dessous : <http://nadelectronics.com/products/made-for-ipod/VISO-1-AP-AirPlay-Bluetooth-Music-System>
- Le NAD VISO 1 AP prend en charge les systèmes audio AirPlay et Bluetooth (codecs SBC, AAC et aptX sur A2DP). Il prend également en charge l'audio numérique directe avec une connexion USB pour les appareils Apple iPod et iOS (iPad, iPhone, iPod touch) pris en charge.

## CONNECTEZ-VOUS ET C'EST TOUT!

### ALIMENTATION

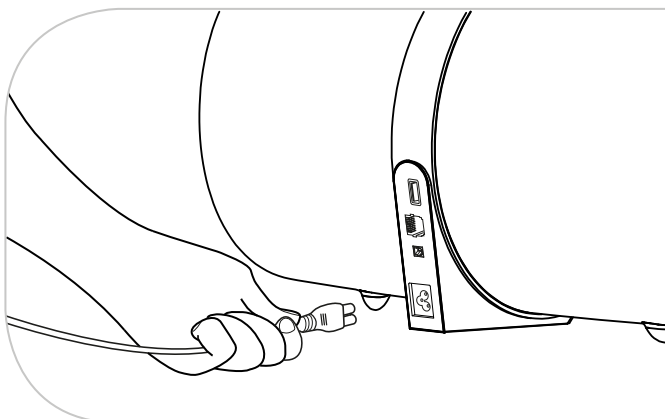

1 Connectez le cordon d'alimentation fourni à l'entrée CA du VISO 1 AP.

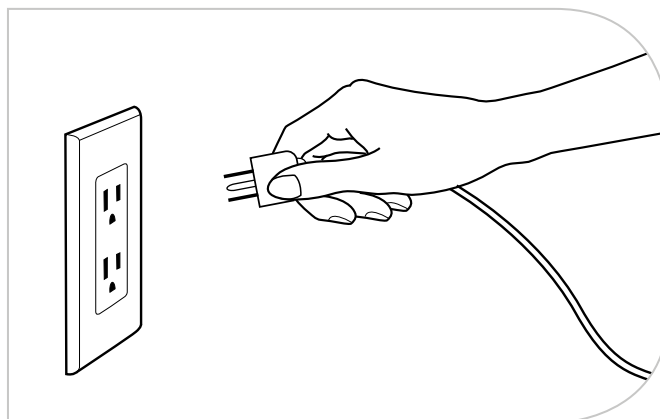

2 Branchez le cordon à une prise de courant CA sous tension.

### APPAREILS iPod OU iOS

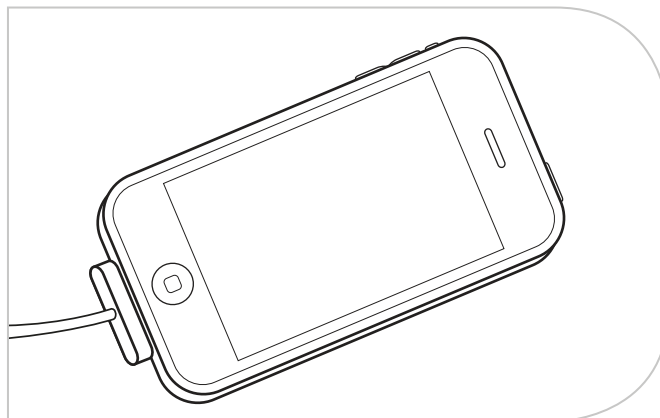
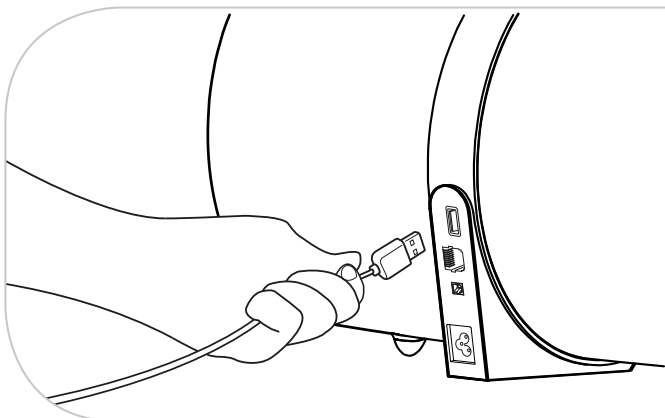

Branchez l'appareil iPod ou iOS à l'entrée USB de votre VISO 1 AP avec le câble USB Apple applicable (non fourni).

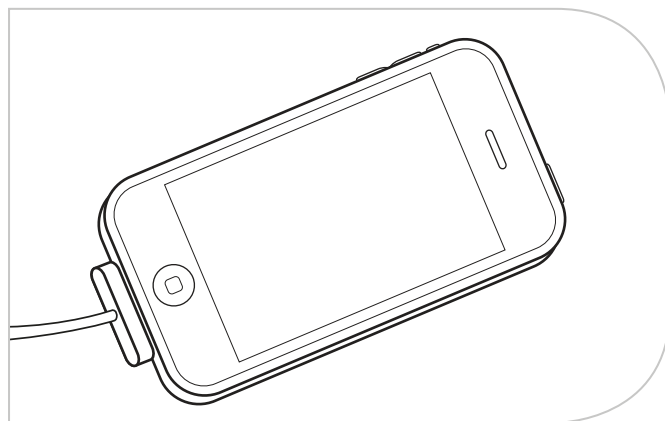
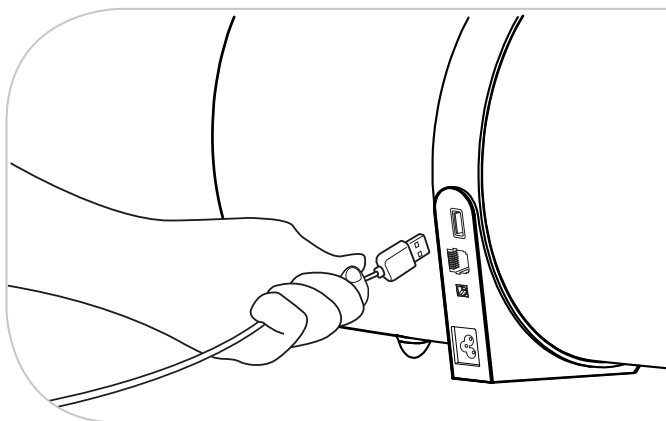

1 En utilisant le câble USB Apple applicable (non fourni), connectez l'appareil iOS à l'entrée USB du VISO 1 AP pour partager les paramètres WiFi.

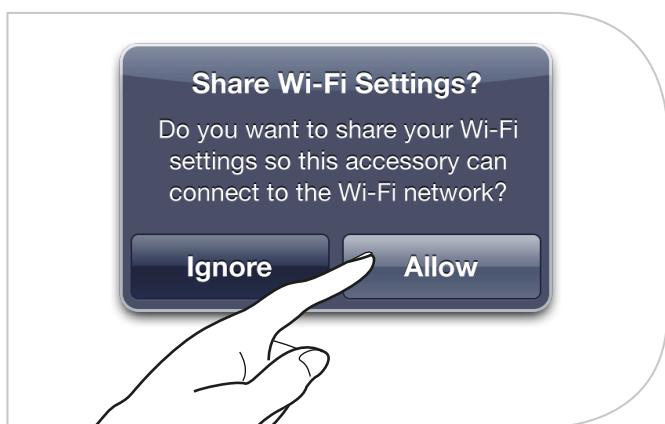
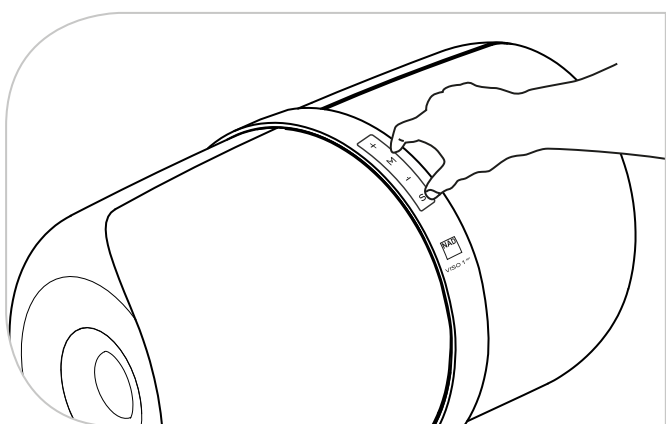

2 Appuyez simultanément sur « M » et sur « S » et tenez-les enfoncés.

3 Sur l'appareil iOS, tapez sur « Allow ». À l'invite, entrez le nom d'utilisateur et le mot de passe réseau. Tapez sur AirPlay [▲].

**REMARQUE :** Après avoir réussi le partage WiFi, vous pouvez déconnecter l'appareil iOS du VISO 1 AP. La source AirPlay prend préséance sur les autres appareils iPod ou iOS connectés.

**APPAREIL EXTERNE AVEC SORTIE OPTIQUE NUMÉRIQUE**

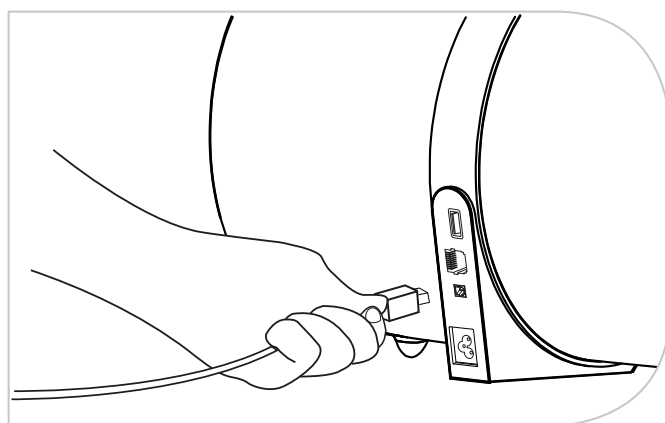
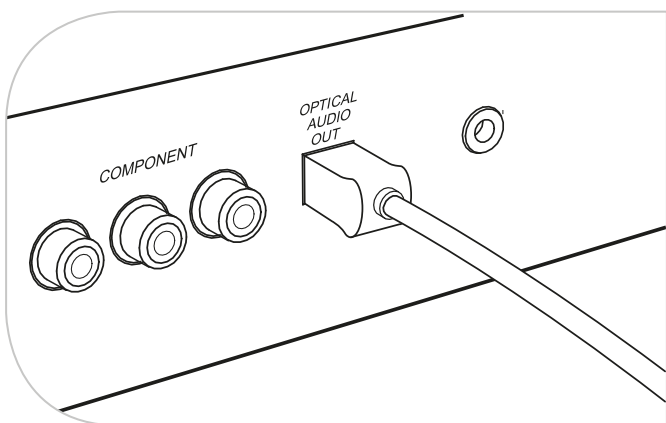

Branchez le VISO 1 AP sur la sortie optique numérique d'un appareil externe au moyen d'un câble optique (non fourni).

Commande de sonnerie :  
Volume

+	Sourdine
M	
-	
S	Sélecteur de source AirPlay/iPod ou appareil iOS → Bluetooth → Optique



Jumelez le NAD VISO 1 AP à votre liste d'appareils Bluetooth.

## CONTENIDO DE LA CAJA

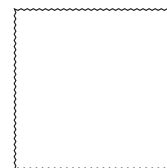
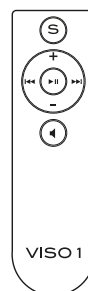
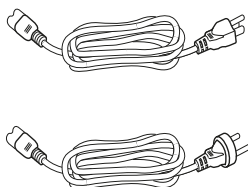
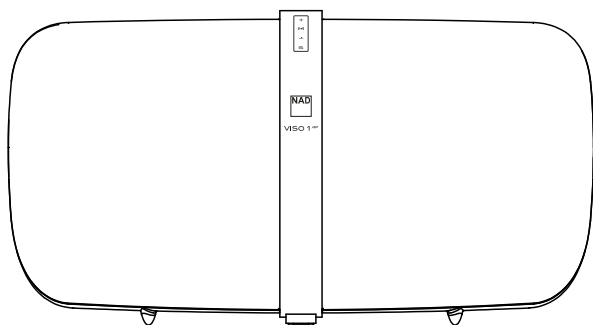

### IMPORTANTE

- Descargue el Manual del usuario para el sistema VISO 1 AP de la ficha Manuals/Downloads (Manuales/descargas) del sitio web de NAD: <http://nadelectronics.com/products/made-for-ipod/VISO-1-AP-AirPlay-Bluetooth-Music-System>
- El sistema NAD VISO 1 AP es compatible con el audio de AirPlay y de Bluetooth (códecs SBC, AAC y aptX mediante perfil A2DP). También es compatible con el audio digital directo mediante una conexión USB a los dispositivos iPod e iOS de Apple (iPad, iPhone e iPod touch).

ESPAÑOL

## CONÉCTESE, PLUG AND PLAY

### CONEXIÓN A LA ALIMENTACIÓN

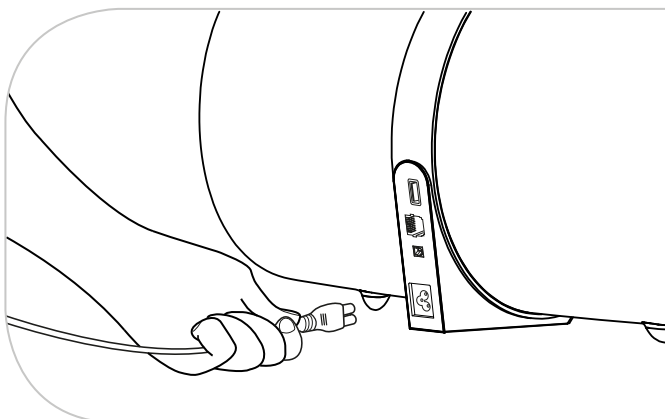

**1** Conecte el cable de alimentación (incluido) a la entrada de suministro de CA del VISO 1 AP.

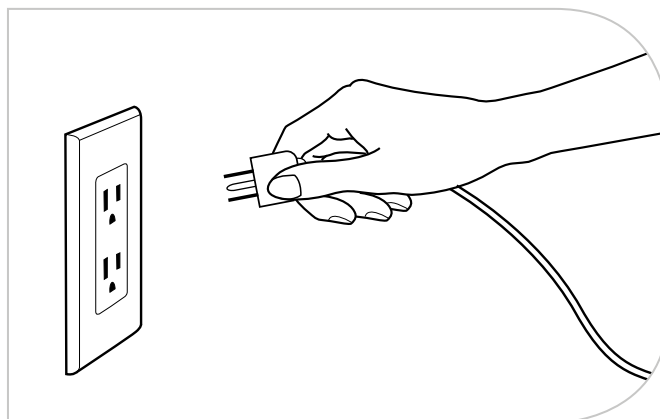

**2** Conecte el cable de alimentación a una toma de CA de pared.

### DISPOSITIVOS iPod O iOS

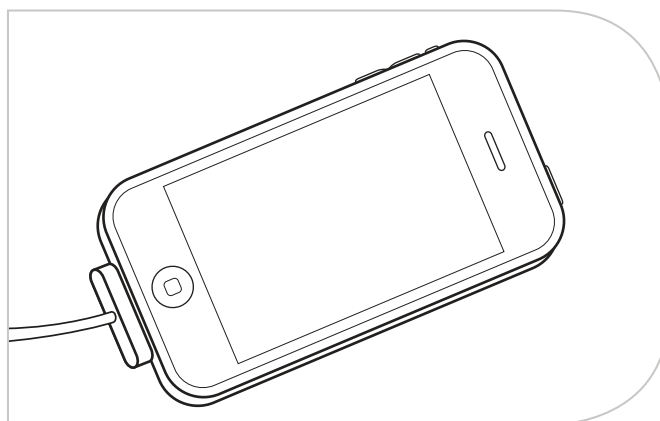
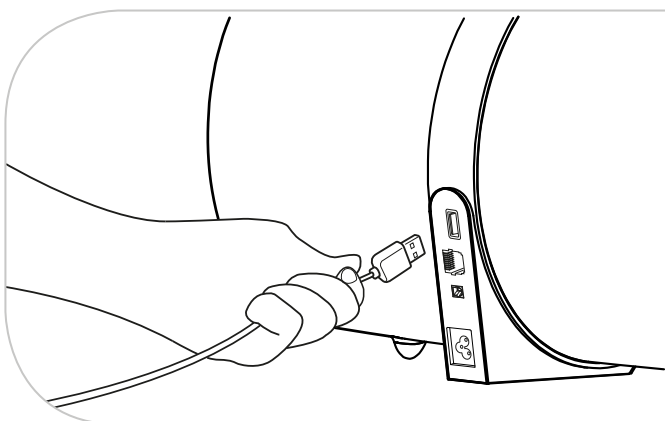

Conecte el dispositivo iPod o iOS a la entrada USB del VISO 1 AP con el cable Apple USB apropiado (no incluido).

## AIRPLAY

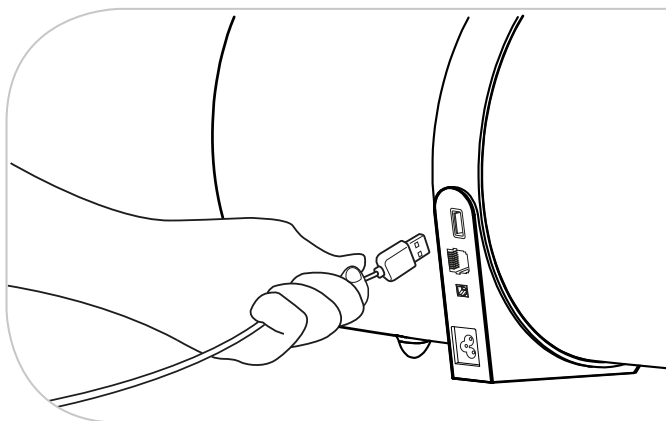

- 1 Con el cable Apple USB apropiado (no incluido), conecte el dispositivo iOS a la entrada USB del VISO 1 AP para compartir la configuración WiFi.

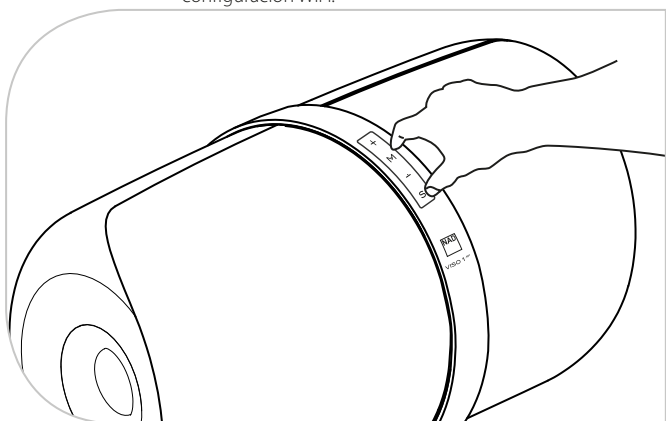
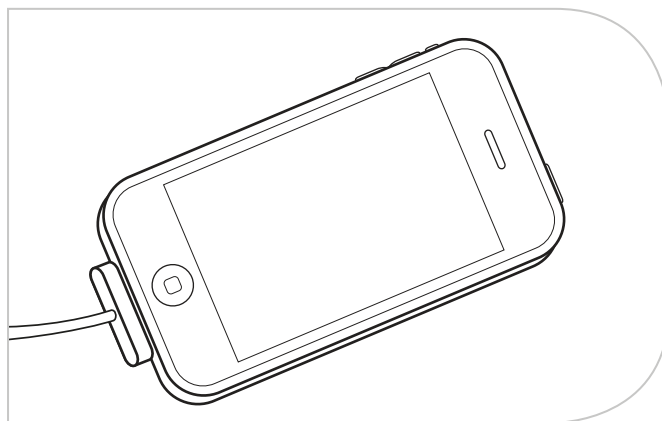

- 2 Mantenga pulsados los botones "M" y "S".



- 3 En el dispositivo iOS, pulse el botón Allow (Permitir). Cuando se le solicite, introduzca el nombre de usuario y la contraseña correctos. Pulse AirPlay .

**NOTA:** Después de compartir la configuración WiFi, puede desconectar el dispositivo iOS del VISO 1 AP. Como fuente, AirPlay tiene prioridad sobre los dispositivos iPod o iOS conectados.

## DISPOSITIVO EXTERNO CON SALIDA ÓPTICA DIGITAL

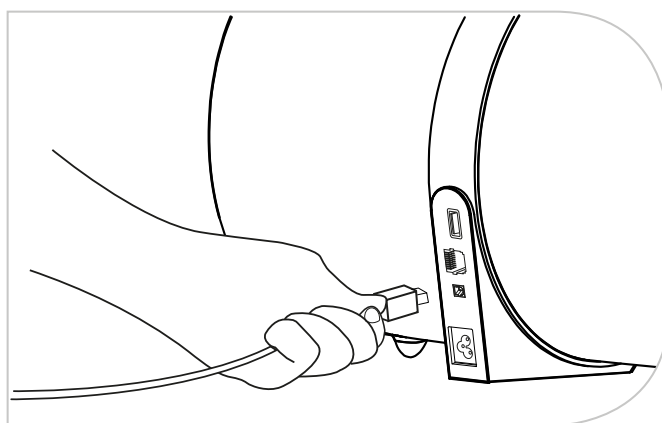
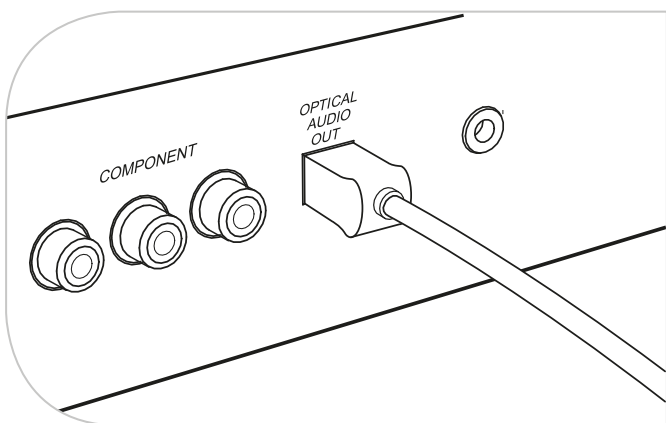

Conecte el VISO 1 AP a la salida óptica digital de un dispositivo externo con un cable óptico (no incluido).



Empareje el NAD VISO 1 AP con su lista de dispositivos Bluetooth.

## CONTEÚDO DA CAIXA

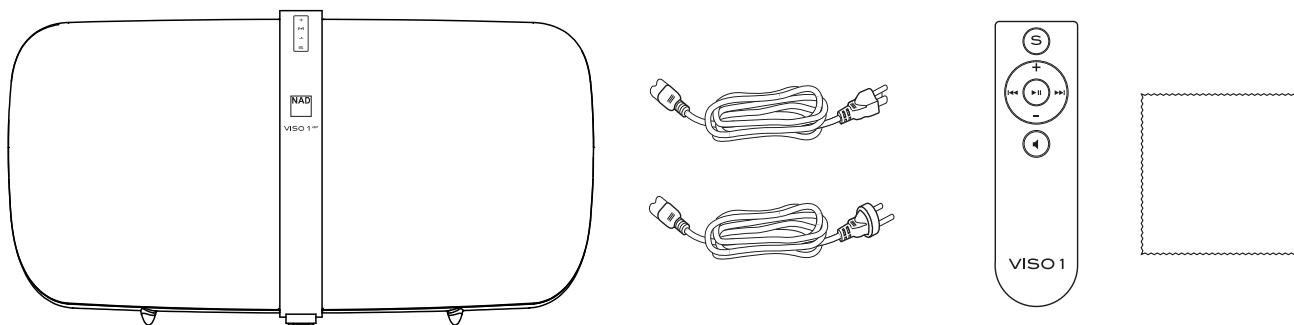

### IMPORTANTE!

- Transfira o Manual do Utilizador do VISO 1 AP a partir do separador Manuals/Downloads (Manuais/Transferências) do website NAD: <http://nadelectronics.com/products/made-for-ipod/VISO-1-AP-AirPlay-Bluetooth-Music-System>
- O NAD VISO 1 AP suporta AirPlay e Áudio Bluetooth (codecs SBC, AAC e aptX através de A2DP). Suporta também áudio digital directo através de uma ligação USB com dispositivos Apple iPod e iOS (iPad, iPhone, iPod touch) suportados.

## LIGAR E REPRODUZIR!

### LIGAR!

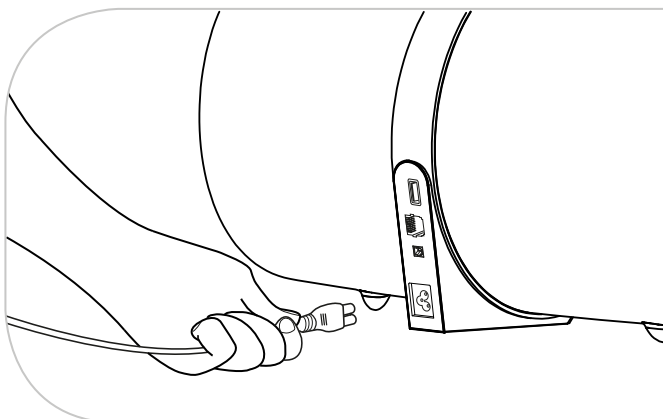

**1** Ligue o cabo de alimentação fornecido à entrada de alimentação CA do VISO 1 AP.

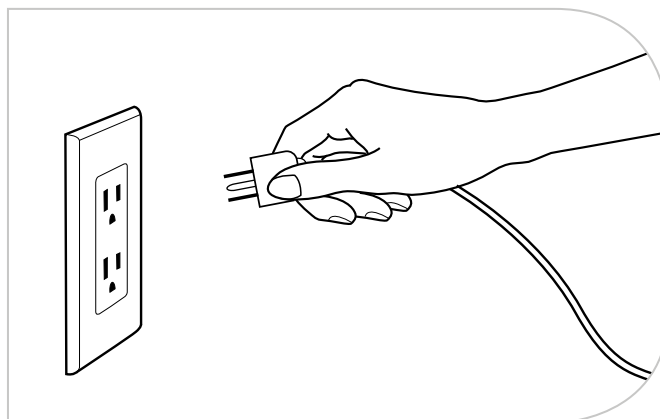

**2** Ligue o cabo de alimentação a uma tomada de parede CA com corrente.

### DISPOSITIVOS iPod OU iOS

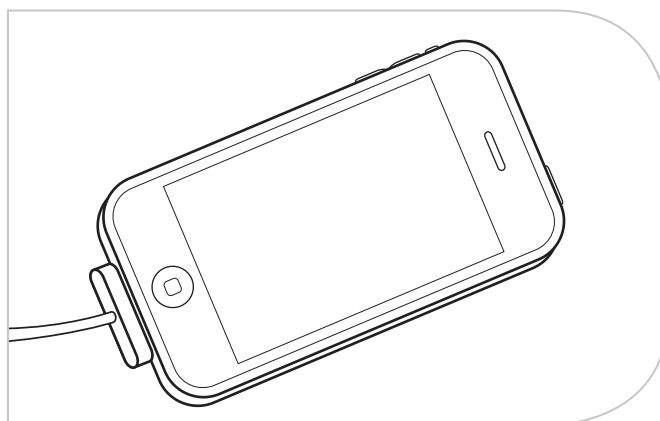
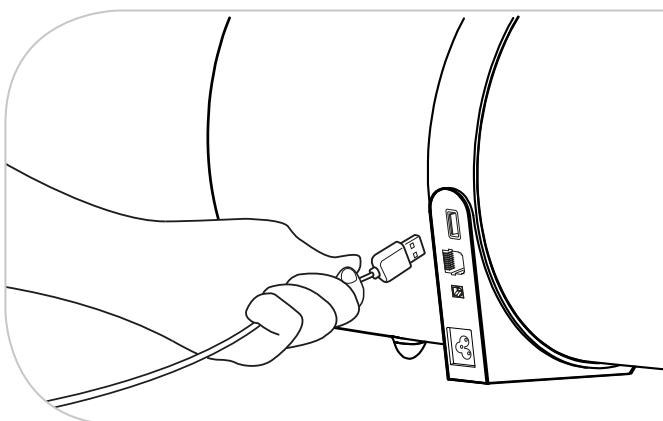

Ligue o dispositivo iPod ou iOS à entrada USB do VISO 1 AP utilizando o cabo USB Apple aplicável (não fornecido).



## AIRPLAY

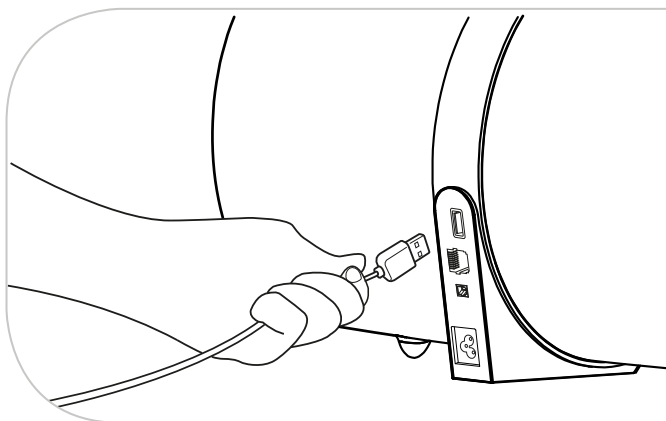

1 Utilizando o cabo USB Apple aplicável (não fornecido), ligue o dispositivo iOS à entrada USB do VISO 1 AP para partilhar as definições de Wi-Fi.

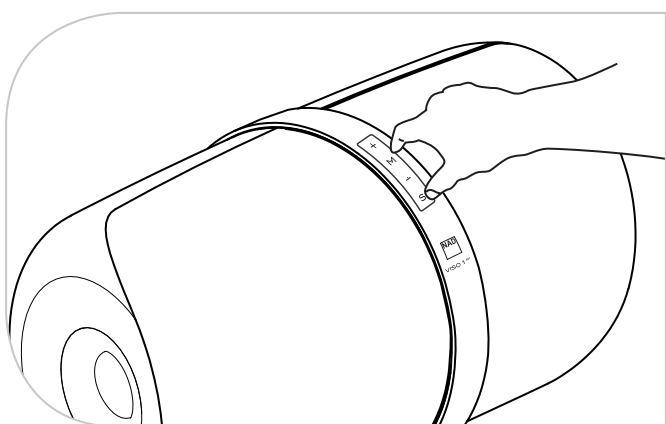
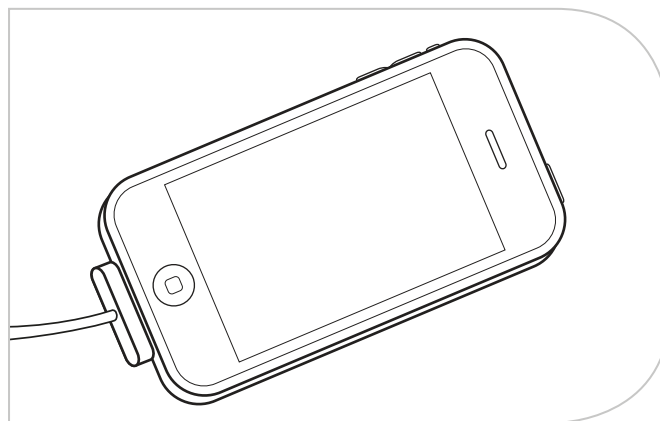

2 Prima sem soltar "M" e "S".



3 No dispositivo iOS, toque em "Allow" (Permitir). Quando solicitado, introduza o nome de utilizador e a palavra-passe de rede correctos. Toque em AirPlay .

**NOTA:** Depois de partilhar com sucesso a rede Wi-Fi, pode desligar o dispositivo iOS do VISO 1 AP. A Source (Fonte) AirPlay tem prioridade sobre os dispositivos iPod ou iOS ligados.

PORTUGUÊS

## DISPOSITIVO EXTERNO COM SAÍDA DIGITAL ÓPTICA

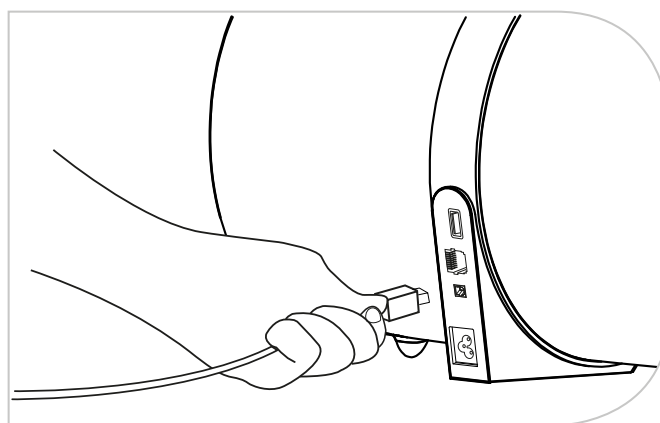
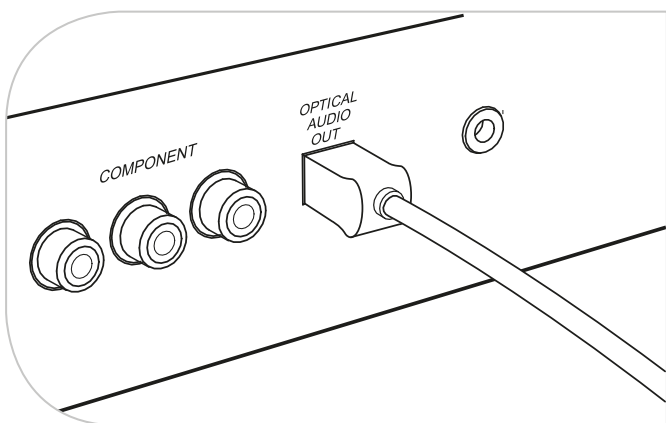

Ligue o VISO 1 AP à saída digital óptica de um dispositivo externo, utilizando um cabo óptico (não fornecido).



Emparelhe o NAD VISO 1 AP de modo a que apareça na lista de dispositivos Bluetooth.

## CONTENUTO DELLA CONFEZIONE DEL PRODOTTO

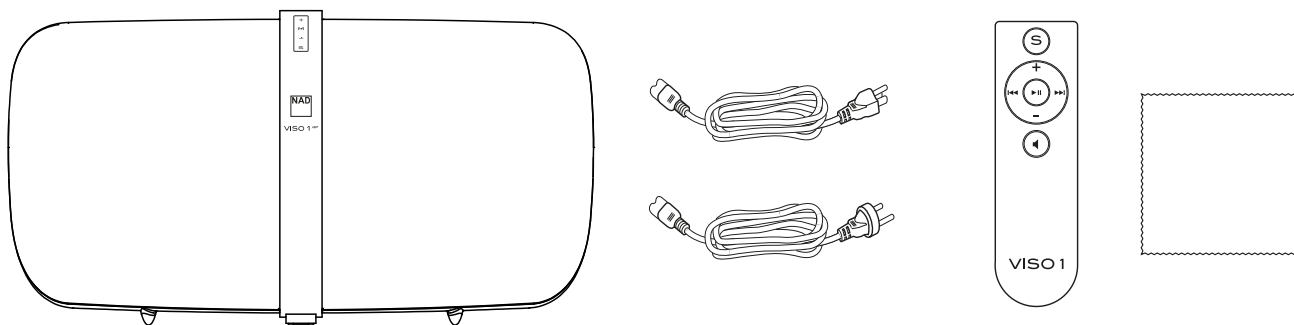

### IMPORTANTE!

- Scaricare il manuale VISO AP 1 dalla scheda Manuals/Downloads del collegamento al sito Web di NAD:  
<http://nadelectronics.com/products/made-for-ipod/VISO-1-AP-AirPlay-Bluetooth-Music-System>
- NAD VISO 1 AP supporta audio AirPlay e Bluetooth (codec SBC, AAC e aptX su profilo A2DP). Supporta inoltre l'audio direct digital su connessione USB con dispositivi Apple iPod e iOS (iPad, iPhone, iPod touch) supportati.

## CONNETTI, PLUG AND PLAY!

### CONNESSIONE ALL'ALIMENTAZIONE

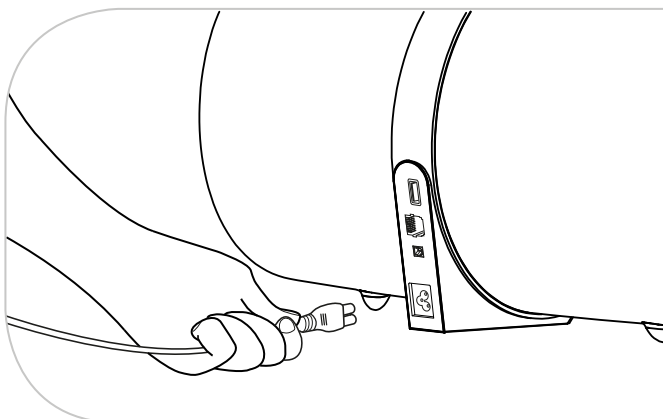

**1** Connettere il cavo di alimentazione in dotazione all'ingresso di alimentazione del VISO 1 AP.

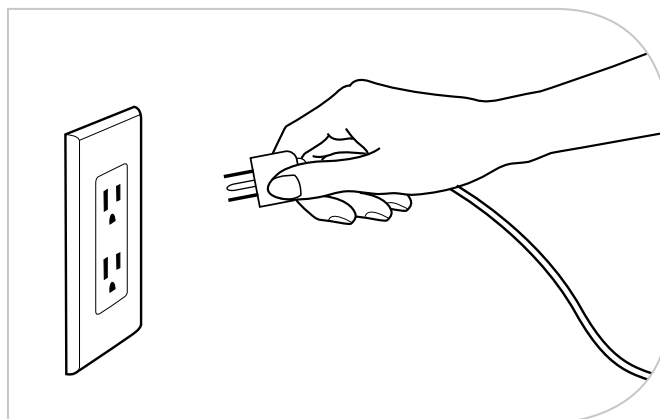

**2** Connettere il cavo di alimentazione a una presa elettrica.

ITALIANO

### DISPOSITIVI iPod O iOS

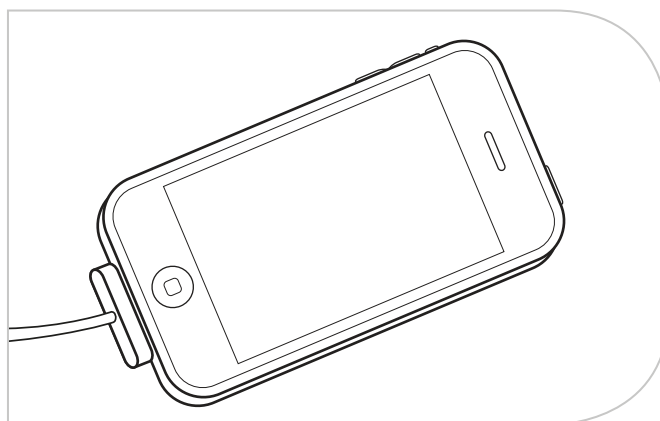
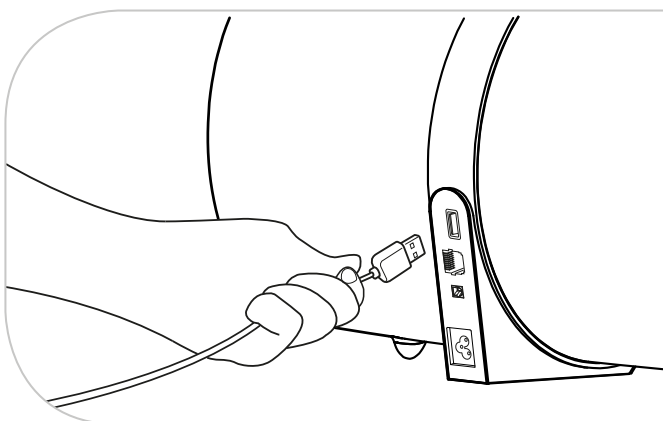

Connettere il dispositivo iPod o iOS a un ingresso USB del VISO 1 AP utilizzando l'apposito cavo USB Apple (non in dotazione).

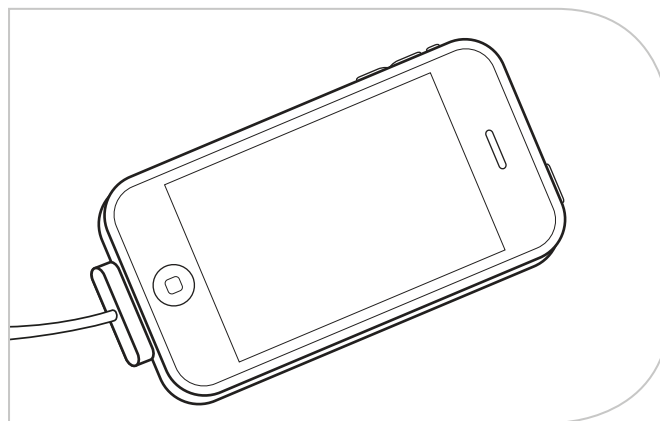
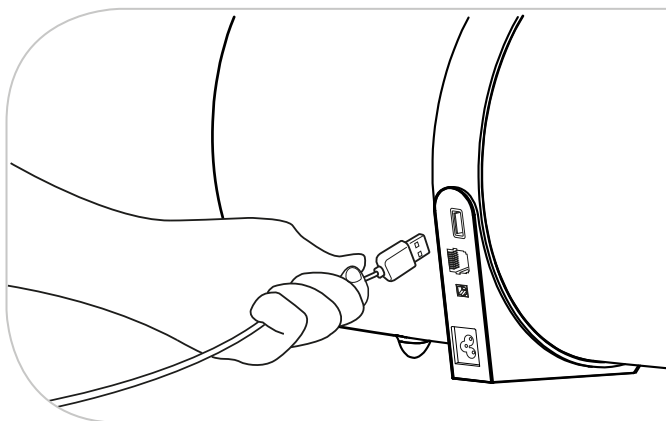

1 Usare l'apposito cavo USB Apple (non in dotazione) per connettere il dispositivo iOS a un ingresso USB del VISO 1 AP in modo da condividere le impostazioni WiFi.

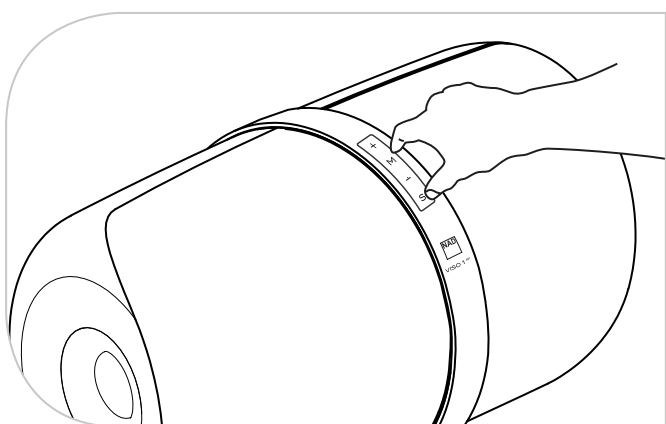

2 Premere e tenere premuto "M" e "S".

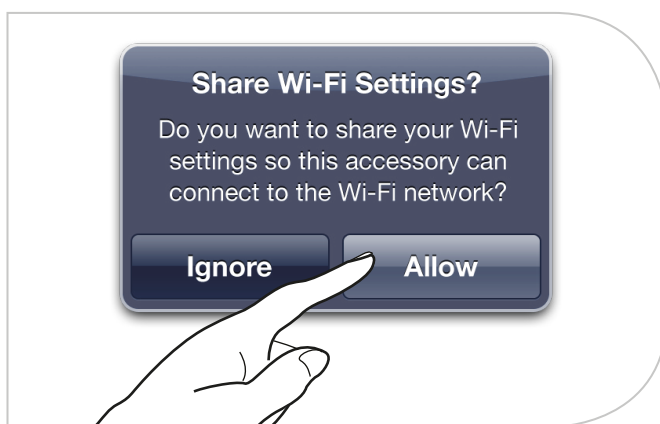

3 Nel dispositivo iOS, toccare "Allow". (Permetti) Quando richiesto, inserire il nome utente di rete e la password corretta. Toccare AirPlay .

**NOTA:** Dopo aver condiviso il WiFi è possibile scollegare il dispositivo iOS dal VISO 1 AP. Come sorgente, AirPlay ha priorità rispetto ai dispositivi iPod o iOS connessi.

## DISPOSITIVO ESTERNO CON USCITA OTTICA DIGITALE

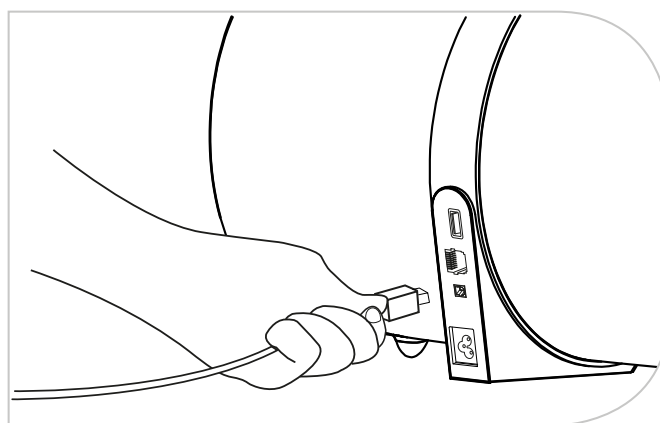
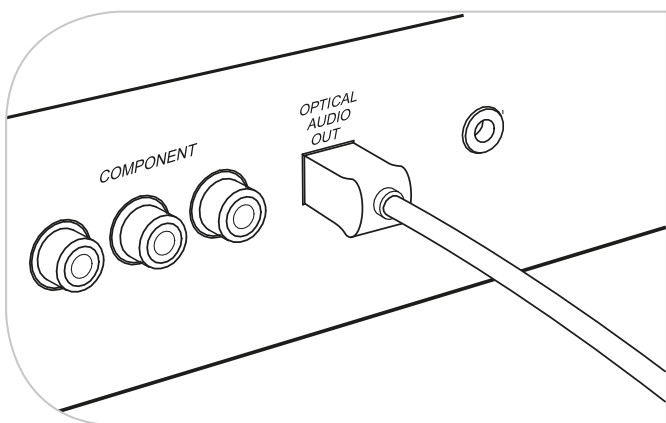

Connettere il VISO 1 AP all'uscita ottica digitale di un dispositivo esterno utilizzando un cavo ottico (non in dotazione).



Associare il NAD VISO 1 AP all'elenco di dispositivi Bluetooth.

## KARTONINHALT

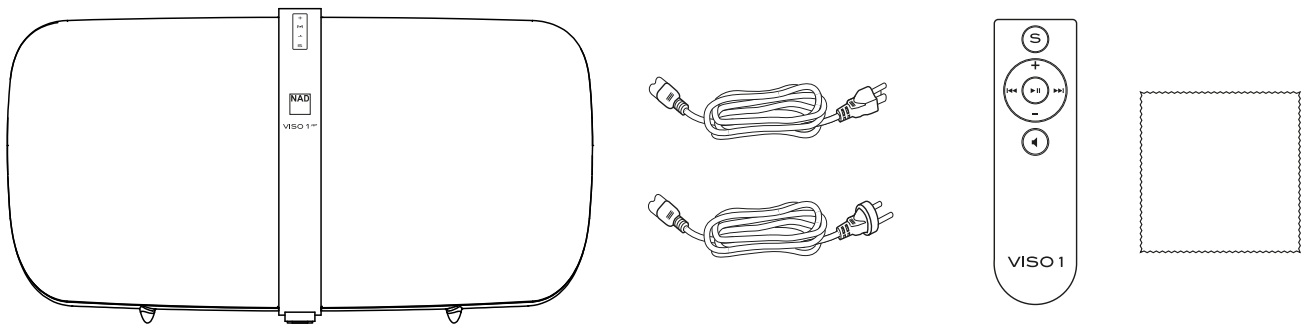

### WICHTIG!

- Laden Sie das VISO 1 AP-Benutzerhandbuch von der Registerkarte „Manuals/Downloads“ (Handbücher/Downloads) auf der NAD-Website herunter: <http://nadelectronics.com/products/made-for-ipod/VISO-1-AP-AirPlay-Bluetooth-Music-System>
- NAD VISO 1 AP unterstützt AirPlay- und Bluetooth-Audio (SBC-, AAC- und aptX-Codex über A2DP). Darüber hinaus wird direktes digitales Audio über USB-Verbindung an unterstützte Apple iPod- und iOS-Geräte (iPad, iPhone, iPod touch) unterstützt.

## ANSCHLIESSEN UND PLUG&PLAY!

### EINSCHALTEN!

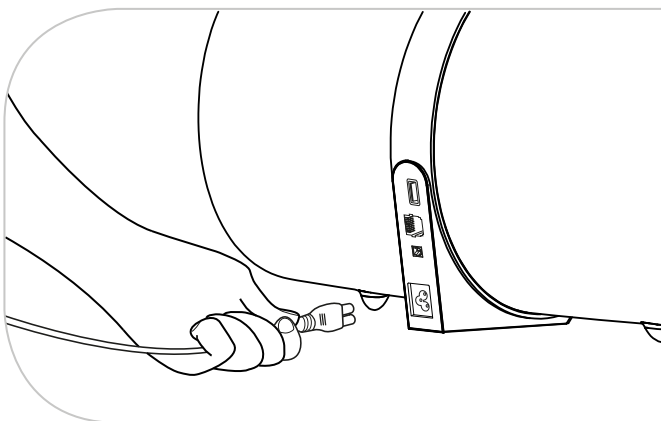

1 Stecken Sie das mitgelieferte Netzkabel in den Netzeingang des VISO 1 AP ein.

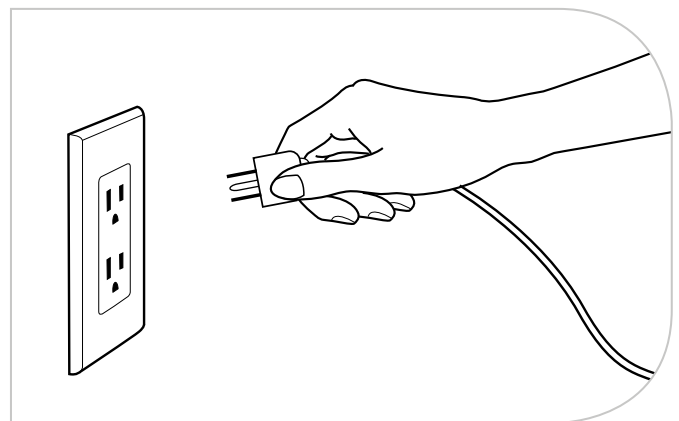

2 Stecken Sie das Netzkabel in eine stromführende Wandsteckdose ein.

### iPod- ODER iOS-GERÄTE

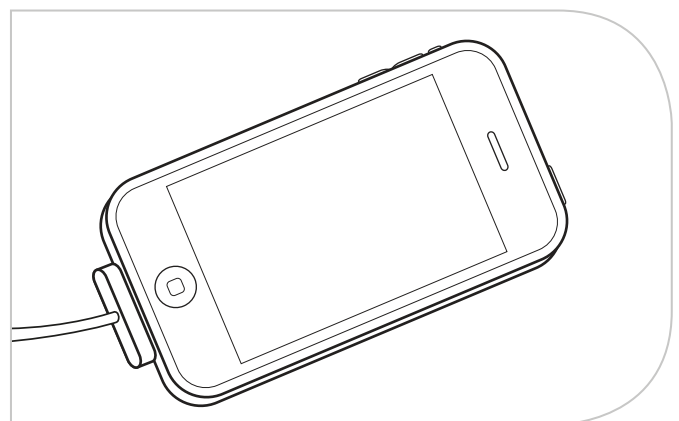
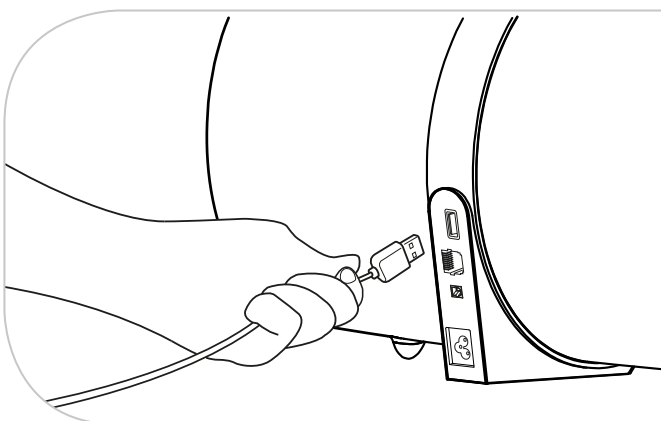

Schließen Sie das iPod- oder iOS-Gerät mit einem entsprechenden Apple USB-Kabel (nicht im Lieferumfang enthalten) am USB-Eingang des VISO 1 AP an.

## AIRPLAY

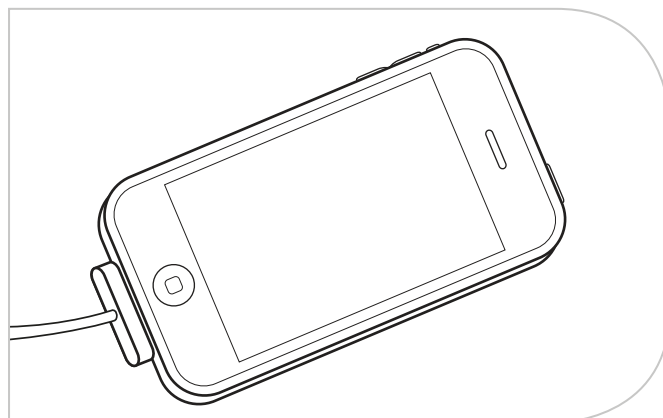
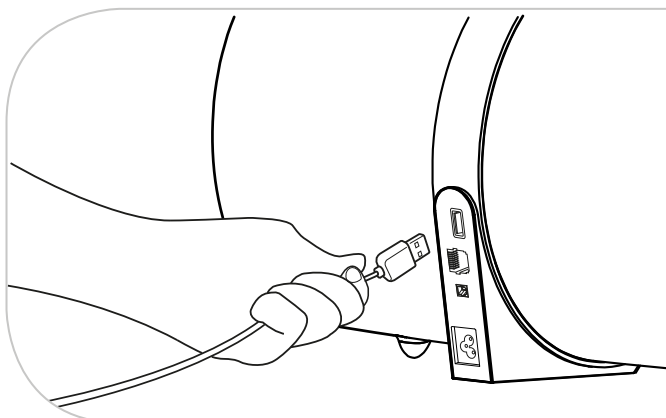

- 1** Schließen Sie das iOS-Gerät mit einem entsprechenden Apple USB-Kabel (nicht im Lieferumfang enthalten) am USB-Eingang des VISO 1 AP an, um die Wi-Fi-Einstellungen freizugeben.

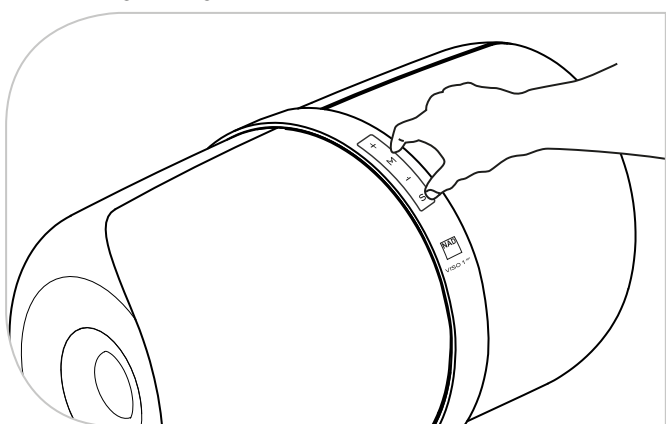

- 2** Halten Sie „M“ und „S“ gedrückt.

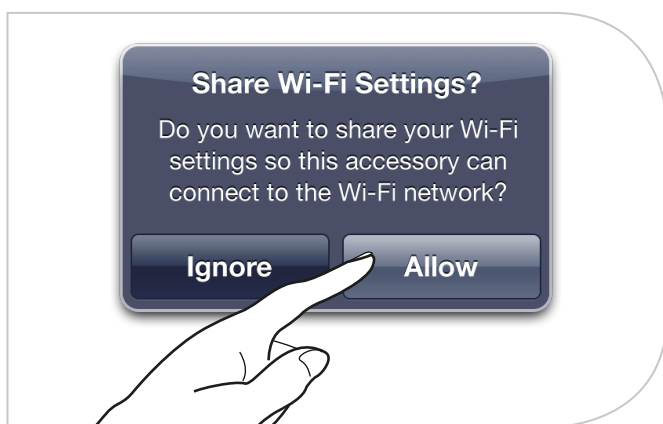

- 3** Tippen Sie auf dem iOS-Gerät auf „Allow“ (Zulassen). Geben Sie den korrekten Netzwerkbenutzernamen und das Kennwort ein, wenn Sie dazu aufgefordert werden. Tippen Sie auf „AirPlay“ .

**HINWEIS:** Nach erfolgreicher Wi-Fi-Freigabe können Sie das iOS-Gerät vom VISO 1 AP trennen. AirPlay hat als Quelle Priorität über angeschlossene iPod- oder iOS-Geräte.

## EXTERNER GERÄT MIT OPTISCHEM DIGITALAUSGANG

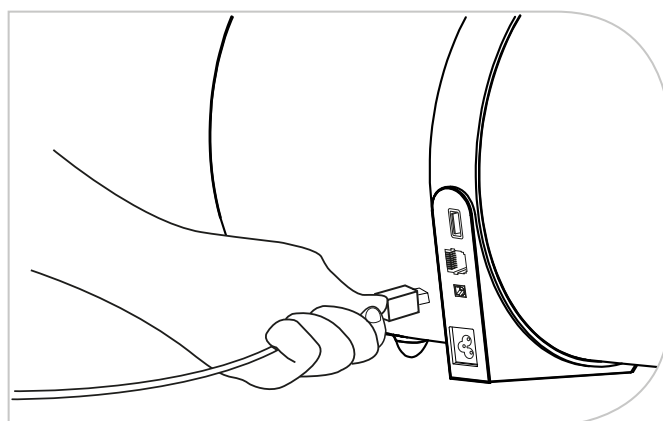
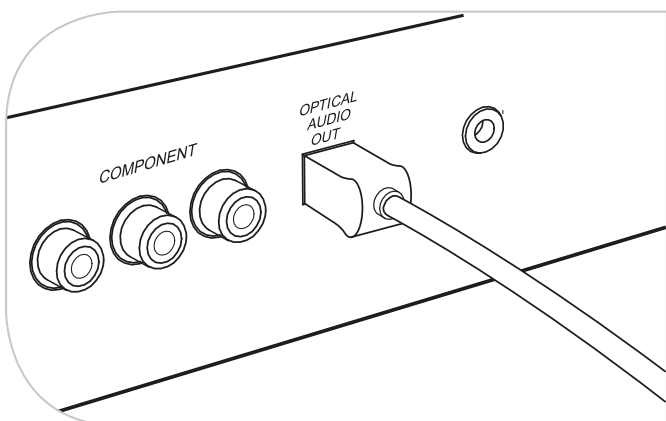

Schließen Sie das VISO 1 AP mit einem optischen Kabel (nicht im Lieferumfang enthalten) am optischen Digitalausgang eines externen Geräts an.

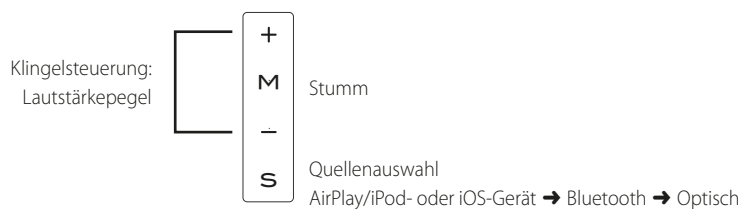

Paaren Sie das NAD VISO 1 AP mit Ihrer Bluetooth-Geräteleiste.



[www.NADelectronics.com](http://www.NADelectronics.com)

**©2013 NAD ELECTRONICS INTERNATIONAL  
A DIVISION OF LENBROOK INDUSTRIES LIMITED**

All rights reserved. NAD and the NAD logo are trademarks of NAD Electronics International, a division of Lenbrook Industries Limited.  
No part of this publication may be reproduced, stored or transmitted in any form without the written permission of NAD Electronics International.  
Apple, iOS, iPad, iPhone, iPod, iPod Touch and AirPlay are trademarks of Apple Inc., registered in the U.S. and other countries.  
Bluetooth® and the Bluetooth logos are trademarks owned by Bluetooth SIG, Inc. aptX is a registered trademark of CSR plc.  
VISO1AP\_INT\_QS\_V04 - MAR 2013